



OPERATOR'S MANUAL

TABLE OF CONTENTS

| | Page |
|--|------|
| PRODUCT OVERVIEW | iii |
| LIST OF WARNINGS AND CAUTIONS | iv |
| 1. PUMP COMPONENTS | 1 |
| EnteraLite® Infinity™ Enteral Feeding Pump | 1 |
| Keypad | 3 |
| Display | 4 |
| Disposable Set | 5 |
| Symbols | 6 |
| 2. DIRECTIONS FOR USE | 7 |
| Priming and Loading the Disposable Set | 7 |
| Operating the Pump | |
| A Single Feeding Example | 10 |
| An Interval Feeding Example | 13 |
| The Battery | |
| Running on Battery Power | 17 |
| Charging the Battery | 18 |
| User Preference Settings | 19 |
| 3. ALARMS, MESSAGES, AND INDICATIONS | 21 |
| 4. CLEANING | 28 |
| 5. ACCESSORIES | 29 |
| 6. SPECIFICATIONS | 31 |
| 7. IMPORTANT PEDIATRIC CONSIDERATIONS | 34 |
| 8. ADDITIONAL TECHNICAL INFORMATION | 36 |
| 9. WARRANTY | 37 |
| LIST OF FIGURES | 38 |
| WHO TO CALL | 41 |
| INDEX | 43 |

PRODUCT OVERVIEW

The EnteraLite® Infinity™ is a rotary peristaltic enteral feeding pump designed to deliver programmed doses of enteral nutrition solutions at selectable rates. It is easy to use with a simple user interface and keypad. ZEVEX technology allows an accuracy rate of +/- 5%, and the ability to safely operate in any orientation. The EnteraLite® Infinity™ system includes a complete line of DEHP-free pump delivery sets with automatic free-flow protection.

The EnteraLite® Infinity™ is designed for both hospital and alternate care use. It is durable, water resistant, and easily carried in a ZEVEX carry pack. The EnteraLite® Infinity™'s size, weight, accuracy, and portability promote and support physical activity.

LIST OF WARNINGS AND CAUTIONS

WARNINGS

- ▶ Use ONLY feeding solutions prescribed by the responsible physician, registered dietitian, registered nurse, or other licensed practitioner.
- ▶ Use ONLY EnteraLite® Infinity™ Disposable Sets to ensure proper fluid delivery. Others will not deliver the correct dose, may allow dangerous free-flow conditions, and may generate hazardous fluid pressures which may activate occlusion alarms at unpredictable pressures.
- ▶ Low flow rates, combined with high dose settings may exceed the life of the disposable set. The disposable set must be replaced every 24 hours to maintain delivery accuracy, allow proper air and occlusion sensing, and prevent growth of bacteria. DO NOT PROGRAM RATE AND DOSE COMBINATIONS WHICH EXCEED A 24 HOUR FEED REGIMEN.
- ▶ The battery capacity is an approximation. If you are unsure that enough capacity remains for your intended use, recharge it.
- ▶ To avoid electrical shock, never clean pump with charger plugged into an outlet or when pump is on.
- ▶ Do not use EnteraLite® Infinity™ Enteral Feeding Pump for delivery of non-enteral solutions. Serious injury may result.
- ▶ Proper operation of pump requires door is closed and latched. Make sure door is closed and latched when motor is running.

-
- ▶ Total Volume may be incorrect due to an interruption of battery power if the overcurrent or temperature protection circuits are triggered. In such a case one of the following conditions occurs:
 - ▶▶ During Single Feeding: Pump enters pause mode, but does not display “DOSE DONE” or turns off (but not due to a low battery).
 - ▶▶ During Interval Feeding: Pump enters pause mode or turns off (but not due to low battery).

CAUTIONS

- ▶ Federal law (U.S.A.) restricts this device to sale by or on the order of a physician, registered dietitian, registered nurse, or other licensed practitioner.
- ▶ Dispose of EnteraLite® Infinity™ Disposable Sets properly, as required by local law.
- ▶ If any leaks are detected in the disposable set, stop pump operation and disconnect set from patient and replace with a new disposable set.
- ▶ Care should be used when manually priming delivery set to ensure cassette is not damaged by excess force.

1. PUMP COMPONENTS

EnteraLite® Infinity™ Enteral Feeding Pump

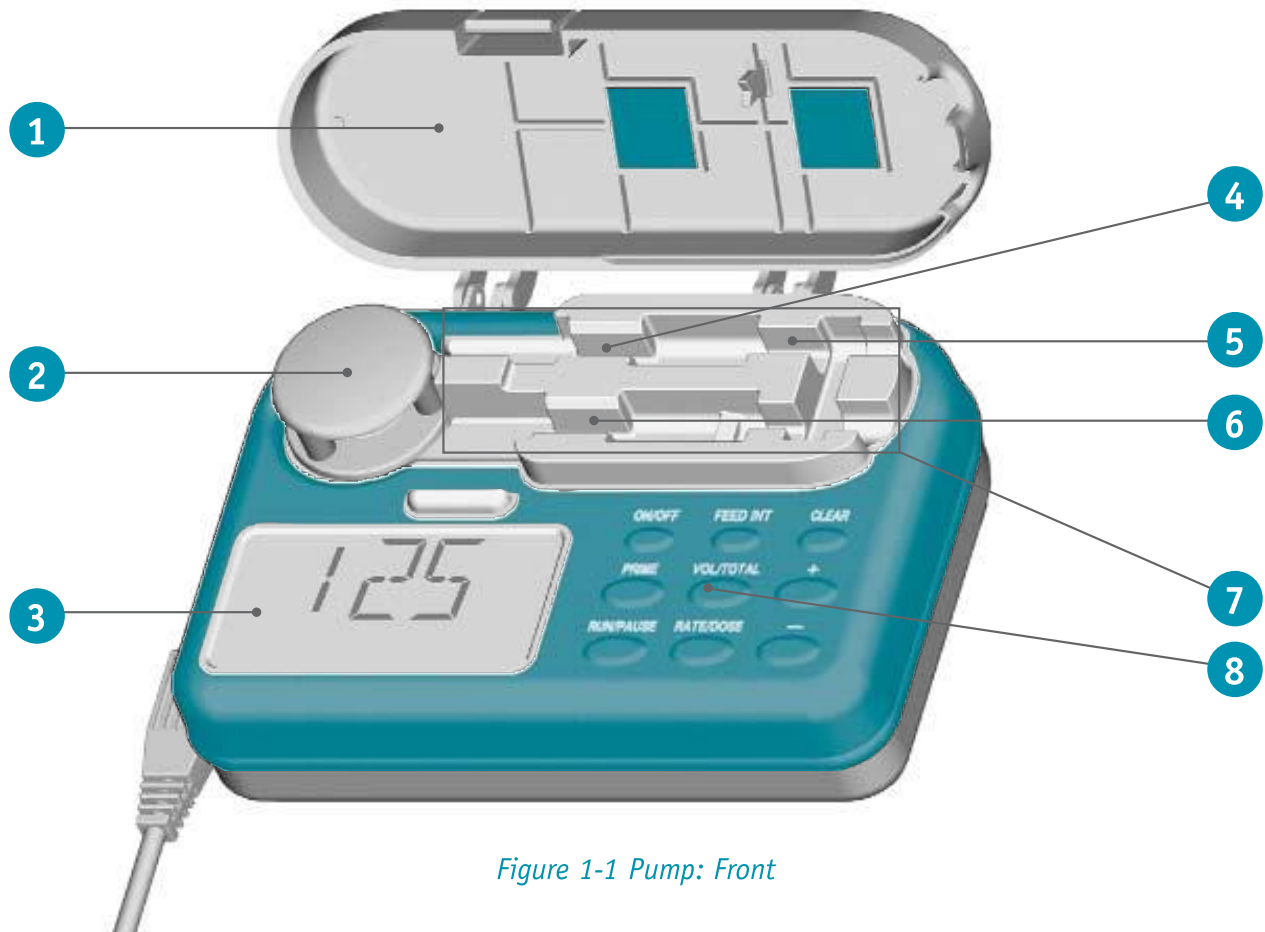

Figure 1-1 Pump: Front

1. Door
2. Pump Wheel
3. Display
4. Upstream Pressure Sensor
5. Air Sensor
6. Downstream Pressure Sensor
7. Receptacle for Cassette
8. Keypad

EnteraLite® Infinity™ Enteral Feeding Pump

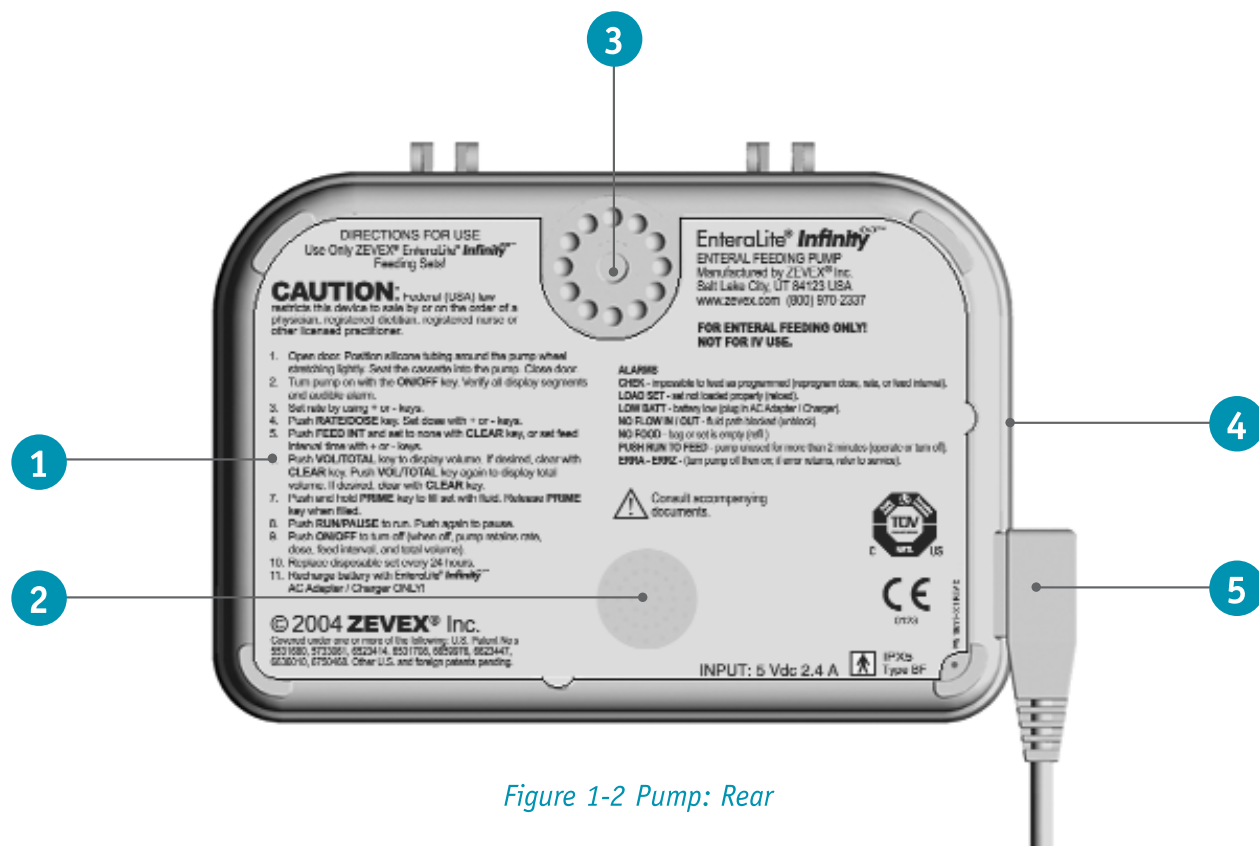

Figure 1-2 Pump: Rear

1. Pump Instruction Label
2. Speaker
3. Receptacle for Pole Clamp
4. Serial Number Label
5. Charger/Power Connector

Keypad



ON/OFF Press key for 1.5 seconds to either turn EnteraLite® Infinity™ on or off.



PRIME Press and hold key to rapidly fill disposable set with fluid. Release key to stop.



RUN/PAUSE Press key to either start pump or place it in pause mode.



FEED INT Press key to display feed interval setting.



VOL/TOTAL Press key once to display volume delivered for current feeding. Press key again to display total cumulative volume delivered in all feed cycles since total volume was last cleared.



RATE/DOSE Press key to transition between rate and dose settings.



CLEAR Press key to reset displayed function to its minimum value.



+ Press key to increase displayed feed function. Press and hold key to increase value rapidly.



- Press key to decrease displayed feed function. Press and hold key to decrease value rapidly.

Note: The following keys only function when pump is in pause mode: **PRIME**, **CLEAR**, **+**, and **-**.



Figure 1-3 Keypad Layout

Display

The display includes large alphanumeric characters, as well as smaller symbols and words. All segments and symbols on the display are shown in *Figure 1-4*.

Settings and messages are displayed in large alphanumeric characters. (*Figure 1-5*)

When the large alphanumeric characters display numbers, one of the smaller words below the characters indicates which function is being displayed. (*Figure 1-6*)

The run symbol indicates pump is running. (*Figure 1-7*)

The wall plug symbol indicates the charger is plugged in, and connected to a live power outlet. The battery symbol indicates pump is running on battery power only. The fuel gauge symbol indicates how much battery charge remains. (*Figure 1-8*)

NOTE: The display light will automatically turn off 10 seconds after the last key is pressed. The light will also remain on for 10 seconds after the charger is connected between pump and live power outlet. If you would prefer the light to remain on when connected to an outlet, you can change the pump light setting to ON. See the User Preference Settings section (*Page 19*) for instructions to change this setting.

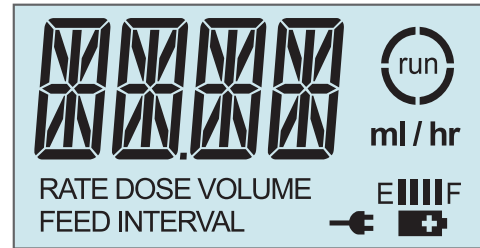

Figure 1-4 Display Segments

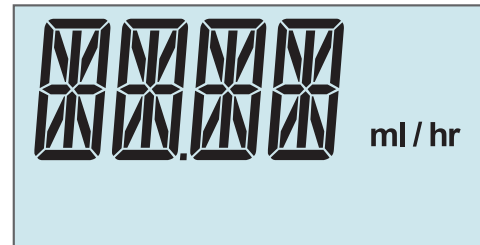

Figure 1-5 Alphanumeric Characters and Units

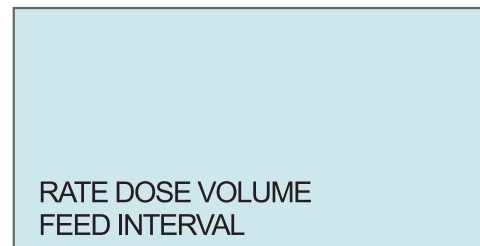

Figure 1-6 Setting Indicators



Figure 1-7 Run Indicators

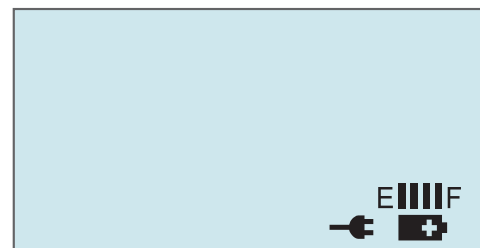

Figure 1-8 Power Indicators

Disposable Set

The only disposable sets approved for use with EnteraLite® Infinity™ pump are:

- ▶ EnteraLite® Infinity™ 500 ml Bag Set, Order Number INF0500
- ▶ EnteraLite® Infinity™ 1200 ml Bag Set, Order Number INF1200
- ▶ EnteraLite® Infinity™ Spike Set, Order Number INF0010

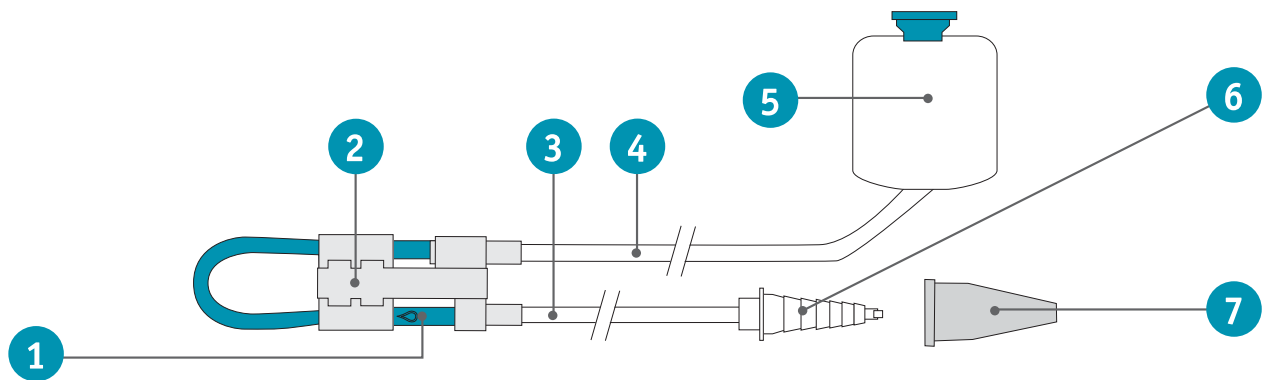

Figure 1-9 EnteraLite® Infinity™ 500ml or 1200ml Bag Set

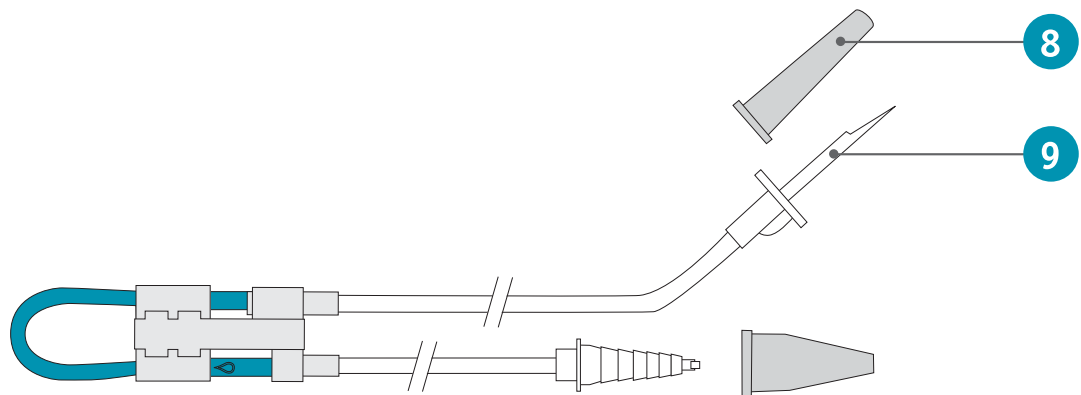

Figure 1-10 EnteraLite® Infinity™ Spike Set

- | | |
|------------------------|-----------------------------|
| 1. "D" Symbol | 6. Barbed Enteral Adapter |
| 2. Cassette | 7. Adapter Protective Cover |
| 3. Downstream Tubing | 8. Spike Protective Cover |
| 4. Upstream Tubing | 9. Spike |
| 5. 500ml or 1200ml Bag | |

Symbols

Brief instructions for operation of pump as well as a brief explanation of each alarm message which pump may communicate are printed on the label attached to pump. These are not intended to be used in place of the Operator's Manual. They are simply a quick reference guide. Please read the Operator's Manual before operating the EnteraLite® Infinity™!



Consult Accompanying Documents!

*Figure 1-11
Consult Accompanying Documents*

The bag symbol is printed on pump door over port where upstream tubing enters pump.

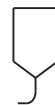

*Figure 1-12
Feeding Bag Connection*

The patient symbol is printed on pump door over port where downstream tubing exits pump.



*Figure 1-13
Patient Connection*

EN 60601-1 Type BF degree of protection against electrical shock. No electrical connection to patient. Drop from any angle from height of 3 feet shall not damage pump operation.



*Figure 1-14
Type BF Shock Protection*

IEC 529 degree of protection against water entering the enclosure. Water jets from any direction shall have no effect.

IPX5

*Figure 1-15
IEC 529*

This symbol is printed on pump delivery sets. It indicates only one patient should use each disposable set.



*Figure 1-16
Single Patient Use*

This symbol is printed on pump delivery sets. It indicates pump delivery sets are made with materials that do not contain the plasticizer DEHP.



*Figure 1-17
DEHP-free*

2. DIRECTIONS FOR USE

Recommendation for First Use:

Since battery may not be fully charged when pump is first received, it is recommended that battery be charged for 6 hours prior to operating on battery power (see Page 18 for additional information).

Priming and Loading the Disposable Set

Step 1:

If you are using the spike set with a vented bottle or pre-filled bag:

Remove protective cover from spike, and insert spike into spike adapter of formula container (Figure 2-1).

If you are using the 500ml or 1200ml disposable set:

Hold bag upright and pour in feeding solution (Figure 2-2). Close cap securely.

NOTE: Blenderized or aggressively mixed solutions may have foam. If using this type of solution, allow it to sit for 10 to 15 minutes before pouring into bag. This will reduce the chance of an alarm due to air in the tubing.

Step 2:

Remove protective cover from barbed adapter. If using pole clamp, protective cover may be held in the groove on back of clamp (Figure 2-3).

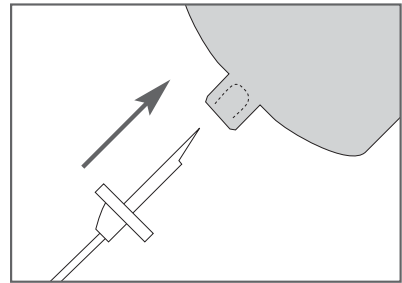

Figure 2-1 Spike Container

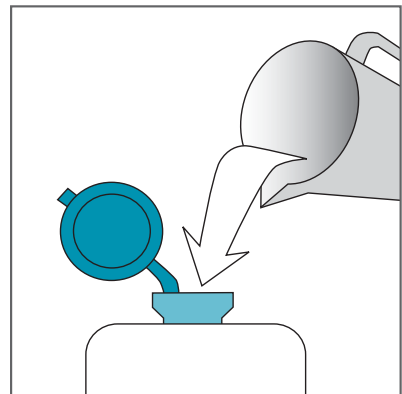

Figure 2-2 Fill Bag

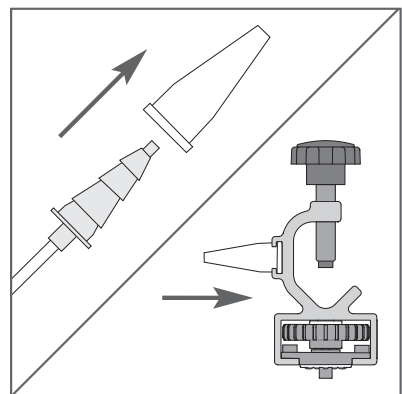



Figure 2-3 Remove Cover from Barbed Adapter / Place Cover on Pole Clamp



NOTE: If set is to be used with a carry pack, all air must be removed from bag and tubing. **Continue to step 3 for instructions on removing air.** If set is to be hung above pump, i.e. on an IV pole, **you may skip to step 4.**

Step 3:

Turn bag upside down and gently squeeze. Tilt bag as needed to keep air at tubing port (Figure 2-4).

Step 4:

Gently pinch teal colored tubing **below** “” symbol. Hold this position until air is removed from tubing. Gently squeeze bag at same time to assist fluid flow. If fluid does not flow, pinch may be too tight (Figure 2-5).

NOTE: Inside the teal colored tubing, below the “” symbol is the in-line occluder. By pinching tubing gently, the tubing moves away from the in-line occluder allowing fluid to flow (Figure 2-6). It is important to only pinch the tubing below the “” symbol to avoid damaging the in-line occluder.

NOTE: Air may also be removed from tubing using the pump prime feature. See step 7 for instructions on using the pump prime feature.

Step 5:

Loop silicone tubing around pump wheel stretching lightly. Seat cassette into pump (Figure 2-7). **Close pump door** (Figure 2-8).

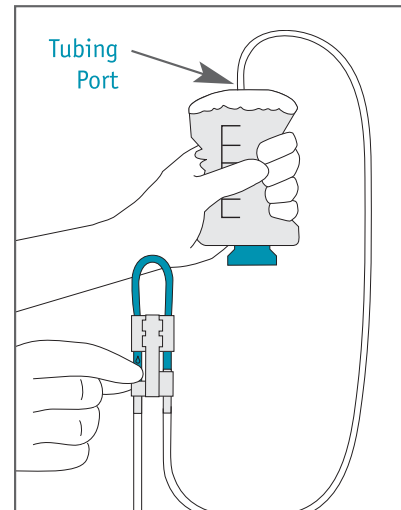

Figure 2-4 Squeeze Bag

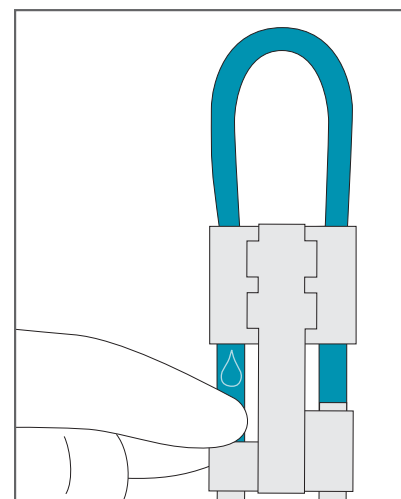

Figure 2-5 Pinch Tubing

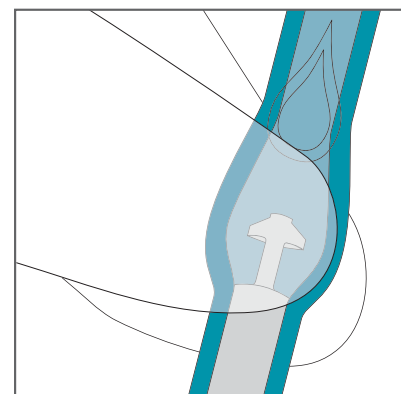

Figure 2-6 Tubing Segment Being Pinched

Step 6:

Press and hold **ON/OFF** key for 1.5 seconds to turn pump on. While pump runs through a self test, display will light and an audible alarm will sound as pump displays the nine digit serial number three digits at a time for one second each. The next number displayed for one second, a number beginning with an "R", is the software revision.

Next, alarm will stop and all segments of display will be shown for 2 seconds. **Verify all display segments and symbols are active.**

The self test is completed and pump will then display last programmed rate and will be in pause mode.

If any air is still in the tubing, continue to Step 7 to use pump prime feature.

Step 7:

Press and hold **PRIME** key. Alarm will sound once and pump will begin pumping at the maximum rate of 600 ml/hr. Display will read "TO STOP LET GO" (*Figure 2-9*). Once all air is removed from tubing, release key. Pump will stop, display will revert to last programmed rate, and pump will be in pause mode.

For pump operation instructions:

For a Single Feeding Example, go to *Page 10*.

For an Interval Feeding Example, go to *Page 13*.

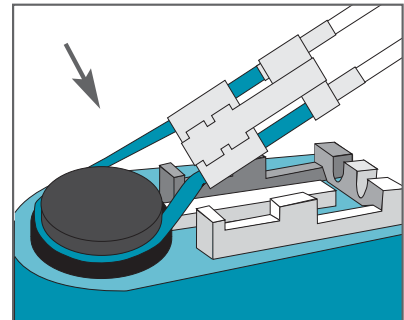

Figure 2-7 Seat Cassette

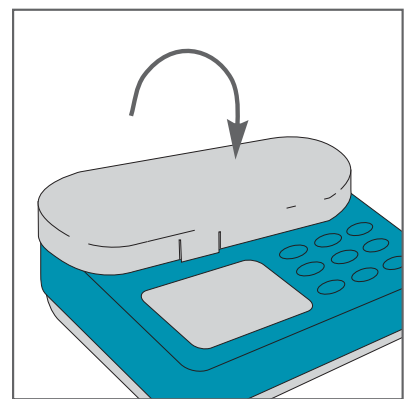

Figure 2-8 Close Pump Door



*Figure 2-9
Priming Indication*

Operating the Pump

A Single Feeding Example

If you want to deliver 500 ml of enteral feeding solution at a rate of 120 ml/hr and then stop the pump:

Key Sequence for "A Single Feeding Example"



Step 1:

Prepare the disposable set with enteral feeding solution as described in the Priming and Loading the Disposable Set instructions (*page 7*).

Step 2:

Hang feeding bag or container so that the bottom of bag is at or above the level of the pump door.

OR - If an EnteraLite® Infinity™ carry pack is to be used, load pump and feeding bag into the proper compartments, securing pump, bag and tubing with the pack's straps (*Page 30*).

Step 3:

Turn pump on by pressing the **ON/OFF** key. After running the self test, display will show last programmed rate.



Figure 2-10 Program Rate to 120 ml/hr

Step 4:

Press the **+** or **-** key to change the rate to 120 ml/hr. Hold down either key to change rapidly (*Figure 2-10*).

Step 5:

Press the **RATE/DOSE** key to display dose. Press the **+** or **-** key until a dose of 500 ml is displayed (*Figure 2-11*).

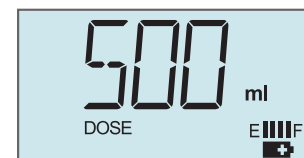
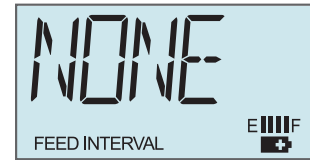

Figure 2-11 Program Dose to 500 ml

NOTE: For a single feeding the Feed interval setting should be programmed to NONE (*Figure 2-12*). When you have finished setting rate and dose check the display to see if it reads FEED INTERVAL. If it does, press the **FEED INT** key, then press the **CLEAR** key. Display will read NONE.



*Figure 2-12
Clear Feed Interval*

Step 6

Connect barbed adapter to the patient's enteral feeding tube.

Step 7

Press the **RUN/PAUSE** key. Pump will begin running. Display will show programmed rate and the arcs around the run symbol will rotate (*Figure 2-13*).



*Figure 2-13
Pump is Running*

While pump is running, the following may be viewed by pressing the appropriate key: Rate, Dose, and Feed Interval.

To view the amount delivered in the current feeding, press the **VOL/TOTAL** key (*Figure 2-14*). This counter will reset itself when the previously programmed dose has been completed and a new feeding is started, or if a feeding is interrupted and Rate, Dose or Feed Interval has been changed.



*Figure 2-14 Amount
Currently Delivered*

To view the amount delivered over the course of several feedings press the **VOL/TOTAL** key a second time. Display will read TOTL then the amount. This counter never resets itself. It can only be reset by the user (*Figure 2-15*).



*Figure 2-15 Total
Amount Delivered*

While pump is running, the settings cannot be changed and the Prime feature is disabled.

If you want to stop pump at any time, press the **RUN/PAUSE** key. Display will show rate, and pump will be in pause mode. Or, turn pump off by pressing the **ON/OFF** key.

When you would like to restart pump, press the **ON/OFF** and/or the **RUN/PAUSE** key. Pump will save the memory of where it was in the feeding before stopping. Press the **RUN/PAUSE** key and pump will restart at the point where it was stopped.

NOTE: Any changes to pump settings during a feeding cycle will cause pump to start a new feeding; it will not start where it left off.

Feeding Completion:

When the dose has been completely delivered, pump will stop running, and display will read DOSE DONE. Pump will be in a pause mode until it is turned off or feeding is restarted. To clear DOSE DONE, press and hold the **ON/OFF** key for 1.5 seconds to turn pump off, or press the **RUN/PAUSE** key to put pump in pause mode. Adjustments to settings can be made at this time, or press the **RUN/PAUSE** key a second time to start another feeding using same rate, dose, and feed interval settings.

If you would prefer the alarm to sound when the dose is complete, you can change the pump dose complete alarm setting to BEEP WHEN DONE. See the User Preference Settings section (*Page 19*) for instructions to change this setting. When set to BEEP WHEN DONE, the pump will stop at the end of the feeding, beep intermittently, and display will read DOSE DONE (*Figure 2-16*). To silence alarm when the dose is complete, press and hold the **ON/OFF** key for 1.5 seconds to turn pump off, or press the **RUN/PAUSE** key to put pump in pause mode.



Figure 2-16 DOSE DONE

NOTE: To program an infinite dose, press and hold the **+** key until display reads INF. When an infinite dose has been programmed, pump will not alarm DOSE DONE. Pump will run continuously as long as feeding solution remains in the bag. When empty, pump will alarm NO FOOD or NO FLOW IN.

Next Feeding:

Turn pump on. Previous settings for rate, dose, and feed interval will be saved in memory. If no changes are required, verify each setting is correct and restart pump running.

NOTE: Rate, dose, and feed interval settings can be locked so that changes cannot be made. See the User Preference Settings section (*Page 19*) for instructions to change this feature.

Operating the Pump

An Interval Feeding Example

If you want to deliver 100 ml of enteral feeding solution at a rate of 50 ml/hr, and repeat this feeding every 6 hours:

Key Sequence for "An Interval Feeding Example"

**Step 1:**

Prepare the disposable set with enteral feeding solution as described in the Priming and Loading the Disposable Set instructions (*Page 7*).

Step 2:

Hang feeding bag or container so that the bottom of bag is at or above the level of the pump door.

OR - If an EnteraLite® Infinity™ pack is to be used, load the pump and feeding bag into the proper compartments, securing pump, bag and tubing with the pack's straps (*see Page 30*).

Step 3:

Turn pump on by pressing the **ON/OFF** key. After running the self test, display will show last programmed rate.

Step 4:

Press the **+** or **-** key to change the rate to 50 ml/hr. Hold down either key to change rapidly (*Figure 2-17*).



Figure 2-17 Program Rate to 50 ml/hr

Step 5:

Press the **RATE/DOSE** key to display dose. Press the **+** or **-** key until a dose of 100 ml is displayed (*Figure 2-18*).

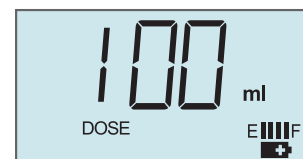

Figure 2-18 Program Dose to 100 ml

Step 6:

Press the **FEED INT** key to display the feed interval setting. Press the **+** or **-** key until 6.00 hr is displayed (*Figure 2-19*).

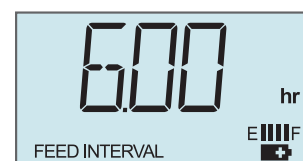

Figure 2-19 Program Feed Interval 6.00 hr

NOTE: The amount of time to complete a rate and dose combination can be figured by dividing the dose by the rate (Dose/Rate = Time). The number of hours to be programmed as the Feed Interval is the amount of time to deliver the dose plus the amount of time pump should pause. Example: 100 ml divided by 50 ml/hr equals 2 hours for feeding delivery, plus a pause of 4 hours equals a feeding interval of 6 hours (100 ml ÷ 50ml/hr = 2 hours running + 4 hours pause = 6 hours from feeding start time to start time).

Pump will calculate number of hours it will take to deliver the RATE and DOSE combination. When the **FEED INT** key is pressed the first available value will be compatible with that combination. In this example the first available value will be 2.00 hr.

Step 7:

Connect barbed adapter to patient's enteral feeding tube.

Step 8:

Press the **RUN/PAUSE** key. Pump will begin running. Display will show programmed rate, the arcs around the run symbol will rotate and display will read FEED INTERVAL (*Figure 2-20*).



*Figure 2-20
Pump is Running*

While pump is running the following may be viewed by pressing the appropriate key: Rate, Dose, and Feed Interval.

To view the amount delivered in the current feeding, press the **VOL/TOTAL** key (*Figure 2-21*). This counter will reset itself when the previously programmed dose has been completed and a new feeding is started, or if a feeding is interrupted and Rate, Dose or Feed Interval has been changed.



*Figure 2-21 Amount
Currently Delivered*

To view the amount delivered over the course of several feedings press the **VOL/TOTAL** key a second time (*Figure 2-22*). Display will read TOTL then the amount. This counter never resets itself, it can only be reset by the user.



*Figure 2-22 Total
Amount Delivered*

While pump is running, the settings cannot be changed and the Prime feature is disabled.

If you want to stop pump at any time, press the **RUN/PAUSE** key. Display will show rate, and pump will be in pause mode. Or, turn pump off by pressing the **ON/OFF** key.

When you would like to restart pump, press the **ON/OFF** and/or the **RUN/PAUSE** key. Pump will save the memory of where it was in the feeding before stopping. Press the **RUN/PAUSE** key and pump will restart at the point where it was stopped.

NOTE: Any changes to pump settings during a feeding cycle will cause pump to start a new feeding; it will not start where it left off.

Feeding Completion:

When the dose has been completely delivered, pump will stop running and display will read NEXT DOSE then give the number of hours and minutes until feeding will be repeated (*Figure 2-23*). Display will show the run symbol flashing without the arcs rotating around it. Pump will repeat this cycle until disposable set is empty or until it is stopped by user.

To stop feeding, press the **ON/OFF** key for 1.5 seconds to turn pump off or press the **RUN/PAUSE** key to put pump in pause mode. Adjustments to settings can be made at this time.



Figure 2-23 Time Until Next Feeding

New Feeding Cycle:

Turn pump on. Previous settings for rate, dose, and feed interval will be saved in memory. If no changes are required, verify each setting is correct and restart pump running.

NOTE: Rate, dose, and feed interval settings can be locked into place so that changes cannot be made. See the User Preference Settings section (*Page 19*) for instructions to change this feature.

The Battery

Running on Battery Power

EnteraLite® Infinity™ will run for 24 hours at a rate of 125 ml/hr. A fully depleted battery takes approximately 6 hours to fully charge.

When pump is running on battery power the battery symbol will appear in the display (Figure 2-24).



Figure 2-24 Battery Power Indicator

The segments or blocks between E and F represent the fuel gauge of the battery. Each block represents approximately 6 hours of charge. When each bar is half spent, it will begin to flash, indicating approximately 3 hours of charge is left for that bar. When the last block is gone, the battery symbol will blink to indicate there is approximately 1 hour of charge left. Display will flash LOW BATT every 3 seconds and pump will beep every 2 seconds to remind user of low battery condition. When battery is fully depleted pump will turn off automatically.

NOTE: The battery life is an approximation based on a fully charged battery and a flow rate of 125 ml/hr. Higher flow rates will run the battery down faster, while lower flow rates and interval feedings will allow the battery to last longer.

The Battery

Charging the Battery

To charge the battery, insert plug from AC Adapter/Charger into port on the left side of pump. Plug charger into a wall outlet.

Pump will charge whether it is turned off or running.

When charger is plugged in and charging, the plug symbol will appear in the display and the fuel gauge will display four scrolling bars from E to F. This pattern continuously repeats while pump is charging (Figures 2-25a through 2-25e). When bars stop scrolling pump is done charging.

To check the status of battery during charging, disconnect charger from pump and then turn on pump.

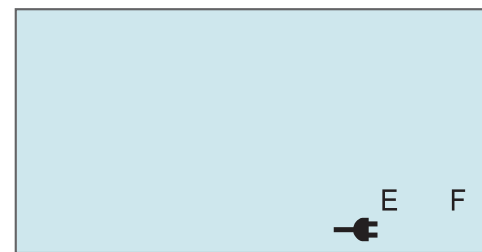

a

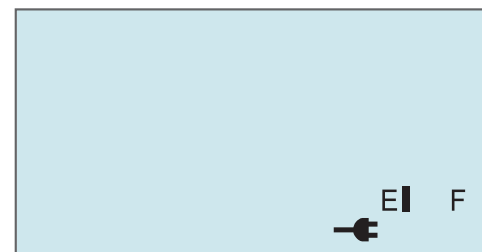

b

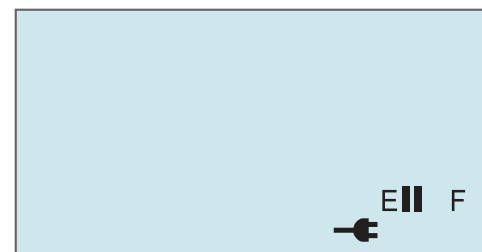

c

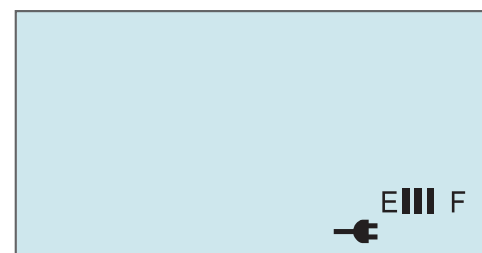

d

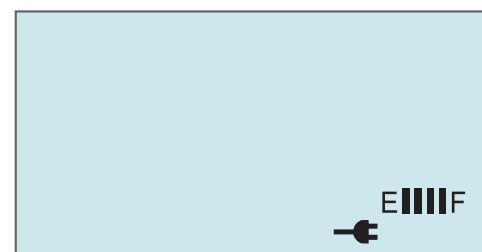

e

Figure 2-25 Fuel Gauge

User Preference Settings

There are four user preference settings. These settings can be changed to fit the user's needs.

Alarm Volume:

The alarm has two volumes, high or low. Pump default is low (*Figure 2-26*).

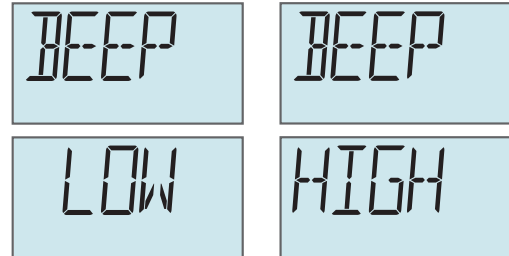

*Figure 2-26 Alarm Volume Settings
BEEP LOW and BEEP HIGH*

Settings Lock:

This allows user to set a rate, dose, and feed interval and then lock those settings so they cannot be changed unintentionally. Pump default is unlocked (*Figure 2-27*).

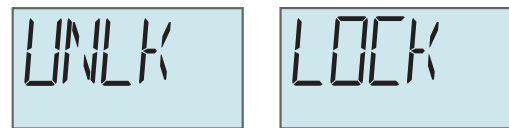

*Figure 2-27 Settings Lock
UNLK and LOCK*

Dose Done:

There are two settings for the Dose Done alarm: MUTE WHEN DONE or BEEP WHEN DONE. Pump default is MUTE WHEN DONE (*Figure 2-28*).

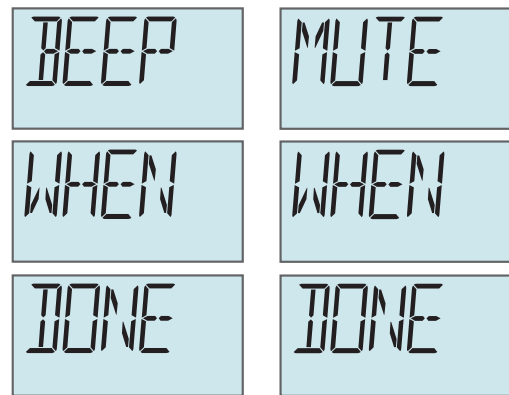

*Figure 2-28 Dose Done Settings
BEEP WHEN DONE and MUTE WHEN DONE*

Backlight:

To conserve battery life, the backlight will turn off automatically 10 seconds after the last key has been pressed. However, while pump is connected to an A/C current the backlight settings can be adjusted. The light can be set to ON or OFF. With the ON setting the backlight will remain on the entire time pump is plugged in to a live power outlet. With the OFF setting, the backlight will turn on when a key is pressed and turn off 10 seconds after the last key has been pressed. Pump default is OFF (*Figure 2-29*).

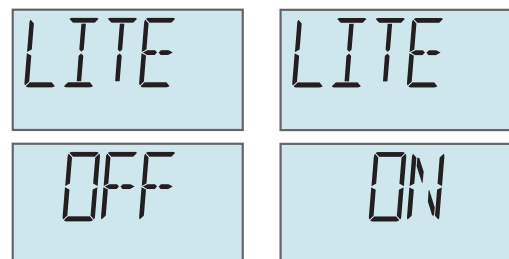

*Figure 2-29 Backlight Settings
LITE OFF and LITE ON*

To adjust these settings:

Key Sequence for “Adjusting User Preference Settings”



Step 1:

With pump turned off, press and hold for 1.5 seconds the **+** and the **ON/OFF** keys at the same time. Pump will beep and then display the words BEEP HIGH or BEEP LOW.

Press the **+** key to change to HIGH or the **-** key to change to LOW. Pump will give a triple beep when the **+** or **-** keys are pressed and setting will change. If setting is as desired, do not press either key.

Step 2:

Press the **PRIME** key. Display will read UNLK (unlocked) or LOCK (locked).

Press the **+** key to change to LOCK (locked) or the **-** key to change to UNLK (unlocked). If setting is as desired, do not press either key.

Step 3:

Press the **PRIME** key again. Display will read MUTE WHEN DONE or BEEP WHEN DONE.

Press the **+** key to change to BEEP WHEN DONE or the **-** key to change to MUTE WHEN DONE. If setting is as desired, do not press either key.

Step 4:

Press the **PRIME** key again. Display will read LITE ON or LITE OFF.

Press the **+** key to change to LITE ON or the **-** key to change to LITE OFF. If setting is as desired, do not press either key.

Step 5:

Press the **ON/OFF** to turn pump off. Setting changes will be saved automatically.

3. ALARMS, MESSAGES, AND INDICATIONS

Following is a list of all alarms, display messages, and indications that are used by the EnteraLite® Infinity™ Enteral Feeding Pump. Each alarm, message, or indication is described in detail on the following pages:

| Figure | Description | Page |
|--------------------|--|------|
| Alarms | | |
| 3-1 | ERRA-ERRZ | 22 |
| 3-2 | LOAD SET | 22 |
| 3-3 | LOW BATT | 22 |
| 3-4 | NO FLOW IN | 23 |
| 3-5 | NO FLOW OUT | 23 |
| 3-6 | NO FOOD | 24 |
| 3-7 | PUSH RUN TO FEED | 25 |
| Messages | | |
| 3-8 | DOSE DONE | 25 |
| 3-9 | NEXT DOSE | 25 |
| Indications | | |
| 3-10 | CHEK | 26 |
| 3-11 | TO STOP LET GO | 26 |
| | Battery Doesn't Hold Its Charge | 27 |
| | Battery Doesn't Charge | 27 |
| | Charger Installed but No Plug Symbol Visible | 27 |

Should any of these alarms or indications continue after troubleshooting, contact your healthcare provider for pump service.

Alarms

ERRA - ERRZ (Figure 3-1)

Pump will sound a continuous beep and display will read ERR followed by a letter to indicate a self-test has failed.

To clear alarm: Turn the pump off and then back on.

LOAD SET (Figure 3-2)

Pump will sound a dual tone beep repeatedly and display will read LOAD SET.

Why: This alarm will sound when pump attempted to run with the set improperly loaded or missing.

To correct the problem: Press the **RUN/PAUSE** key to silence alarm and place pump in pause mode, then check the following:

1. An EnteraLite® Infinity™ Disposable Set is loaded into pump properly and door is closed.
2. Check cassette receptacle for cleanliness, especially around pressure sensors. If cleaning is necessary, refer to *CHAPTER 4 - CLEANING (Page 28)*.

LOW BATT (Figure 3-3)

When 1 hour or less of battery life is available, display will flash LOW BATT every 3 seconds and pump will beep every 2 seconds to indicate battery is low and pump will soon stop running.

To correct problem: Plug in AC Adapter/Charger to recharge battery.

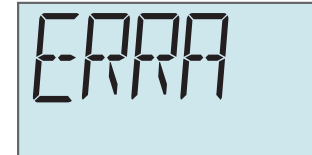

Figure 3-1
ERRA and ERRZ Alarm



Figure 3-2
LOAD SET Alarm



Figure 3-3
LOW BATT Alarm

NO FLOW IN (Figure 3-4)

Pump will sound a dual tone beep repeatedly and display will read NO FLOW IN.

Why: This alarm has occurred because pump has detected blockage in the set between pump and bag.

To correct the problem: Press the **RUN/PAUSE** key to silence alarm and place pump in pause mode, then check the following:

1. Check tubing for kinks or formula clumps. Correct blockage.
2. Check cassette receptacle for cleanliness, especially around the pressure sensors. If cleaning is necessary, refer to *CHAPTER 4 - CLEANING (Page 28)*.

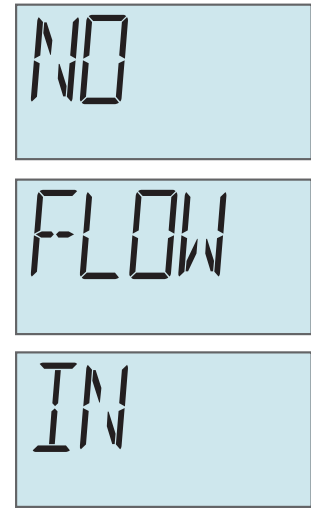

Figure 3-4
NO FLOW IN Alarm

NO FLOW OUT (Figure 3-5)

Pump will sound a dual tone beep repeatedly and display will read NO FLOW OUT.

Why: This alarm has occurred because pump has detected a blockage in the set between pump and patient.

To correct problem: Press the **RUN/PAUSE** key to silence alarm and place pump in pause mode, then check the following:

1. Check tubing for kinks or blockages. Remove kink or blockage.
2. Check cassette receptacle for cleanliness, especially around pressure sensors. If cleaning is necessary, refer to *CHAPTER 4 - CLEANING (Page 28)*.
3. Back pressure from patient may also cause this alarm. Discuss with physician.

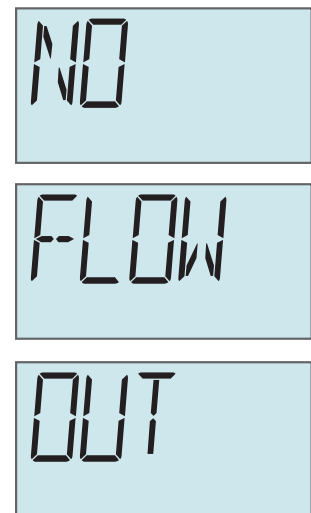

Figure 3-5
NO FLOW OUT Alarm

NO FOOD (Figure 3-6)

Pump will sound a dual tone beep repeatedly and display will read NO FOOD.

Why: This alarm has occurred because pump has detected air in the tubing. It takes approximately 1 ml of air, which is approximately 5 inches (12.7 cm) in length entering the teal colored tubing to cause an alarm.

To correct the problem: Press the **RUN/PAUSE** key to silence alarm and place pump in pause mode, then check the following:

1. Check feeding bag for food. If it is empty, refill bag and prime the set.
2. Check tubing for air bubbles. If bag is full but air is present in the tubing, disconnect set from patient, press and hold the **PRIME** key until air bubble has moved to the end of the tubing.
3. Check cassette receptacle for cleanliness, especially around the air sensor. If cleaning is necessary, refer to *CHAPTER 4 - CLEANING (Page 28)*.
4. Check that an EnteraLite® Infinity™ Disposable Set is loaded into pump properly and door is closed.
5. Check disposable set for worn tubing. If it is worn, replace with a new set.

NOTE: Blenderized or aggressively mixed solutions may have foam. Small foam bubbles may collect in the air sensor area and must be cleared in order to avoid a NO FOOD alarm. Allowing foamy solutions to sit for 10 to 15 minutes after mixing and prior to pouring into the bag will reduce the amount of foam.



Figure 3-6
NO FOOD Alarm

PUSH RUN TO FEED (Figure 3-7)

Pump will sound a dual tone beep repeatedly and display will read PUSH RUN TO FEED.

Why: This alarm has occurred because pump has been in pause mode for 2 minutes.

To correct the problem: Press the **RUN/PAUSE** key to silence alarm and place pump in pause mode again. Program and use pump or press the **ON/OFF** key to turn it off.

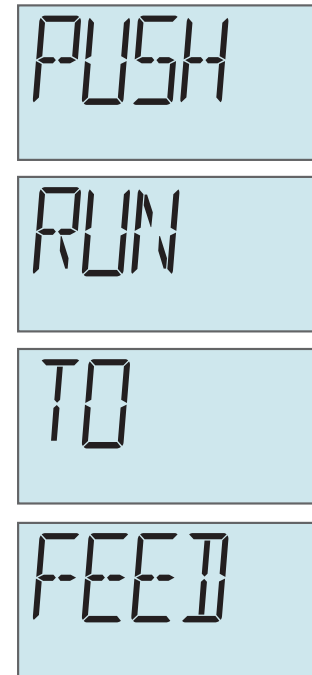

Figure 3-7 PUSH RUN TO FEED Alarm

Messages**DOSE DONE** (Figure 3-8)

This message indicates a single feeding dose has been delivered.

To clear pump: Either press the **ON/OFF** key to turn pump off, or press the **RUN/PAUSE** key to put pump in pause mode before starting another feeding.



Figure 3-8 DOSE DONE Message

NEXT DOSE (Figure 3-9)

If the interval feeding feature is in use, between feedings display will read NEXT DOSE ##.## hr. (##.##, indicates the time in hours and minutes until the next dose begins.)

If the currently programmed feeding is not desired, either press the **ON/OFF** key to turn pump off or press the **RUN/PAUSE** key to place pump in pause mode where adjustments can be made to the settings.



Figure 3-9 NEXT DOSE Message

Indications

CHEK (Figure 3-10)

Pump will sound a dual tone beep once and CHEK, RATE, DOSE, and FEED INTERVAL will all blink on the display.

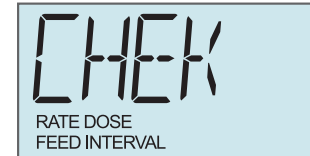

Figure 3-10
CHEK Indication

Why: This alarm sounds when the RATE, DOSE, and FEED INTERVAL are not compatible. As discussed in the Interval Feeding Example (Page 13), pump divides the dose by the rate to determine the amount of time required for the dose to be delivered. Based on the RATE and DOSE combination, when the FEED INTERVAL is being programmed, the first value available will be the first value that is compatible with the RATE and DOSE settings. Should the RATE or DOSE be changed after the FEED INTERVAL has been programmed, and the combination requires the delivery time to be longer than the amount of time programmed as the FEED INTERVAL, user will receive this alarm.

For example, if rate is 100 ml/hr, and dose is 200 ml, then the pump will take 2 hours to deliver the dose. The first available FEED INTERVAL will be 2.00 hr. However, if the dose is changed to 300 ml, the dose will now take 3 hours to deliver and therefore 2.00 hr is an impossible FEED INTERVAL. If the **RUN/PAUSE** key is pressed before the FEED INTERVAL has been changed (the next available value being 3.00), the pump will give the CHEK alarm.



Figure 3-11
Priming Indication

To correct the problem: Press the **RUN/PAUSE** key to put pump in pause mode, and reprogram the settings.

TO STOP LET GO (Figure 3-11)

When pressing and holding the **PRIME** key, alarm will sound once, pump will begin pumping at maximum rate of 600 ml/hr and display will read "TO STOP LET GO".

To stop priming: Release the **PRIME** key.

Battery Doesn't Hold Its Charge

Battery will lose its charge if stored for a long period of time or if stored at high temperatures (such as in an automobile during summer).

To correct the problem: Recharge the battery. If the problem continues, contact your healthcare provider for service.

Battery Doesn't Charge

If the battery symbol and the E and F of the fuel gauge (*Figure 3-12*) are flashing while the pump is plugged in, the battery is not charging.

To correct the problem: Contact your healthcare provider for service.



Figure 3-12 Battery Symbol and the E and F of the Fuel Gauge

Charger Installed but No Plug Symbol Visible

If the plug symbol does not display after the AC Adapter/Charger is plugged into pump and a live power outlet, then charger is not charging battery.

To correct the problem: Check the following:

- ▶ Verify that the wall outlet works by plugging in another appliance, such as a lamp.
- ▶ Charger is connected properly.

If this does not correct the problem, pump or charger may be damaged. Contact your healthcare provider for service.

NOTE: There are no user serviceable or replaceable components inside the EnteraLite® Infinity™.

4. CLEANING

WARNING: To avoid electrical shock, never clean pump or EnteraLite® Infinity™ AC Adapter/Charger with charger plugged into an outlet or pump turned on.

WARNING: Make sure the EnteraLite® Infinity™ AC Adapter/Charger is completely dry before plugging into an electrical outlet.

To clean the EnteraLite® Infinity™ Enteral Feeding Pump:

Pump may be cleaned with warm soapy water and a nonabrasive sponge or soft cloth.

OR - Apply one of the following solutions for approximately 10 minutes, then wipe pump clean with a damp cloth or sponge:

- ▶▶ 5% bleach and water solution
- ▶▶ Multipurpose disinfectant cleaner

You may also rinse the pump by holding it under a stream of warm water. Then, dry with a clean cloth.

Use a cotton swab to gently clean pathways of cassette receptacle.

Compartments of the EnteraLite® Infinity™ pack can be cleaned with a damp sponge. The EnteraLite® Infinity™ pack is machine-washable. Use warm water and gentle cycle, whenever possible. Hang to dry.

EnteraLite® Infinity™ AC Adapter/Charger normally does not require cleaning. When desired, a dry or slightly damp cloth may be used to clean the outside surface of AC Adapter/Charger while it is disconnected from the wall outlet.

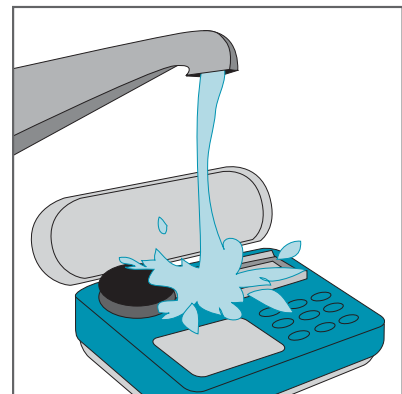

Figure 4-1 Rinsing Pump Under Stream of Water

5. ACCESSORIES

Additional accessories are available for use with EnteraLite® Infinity™:

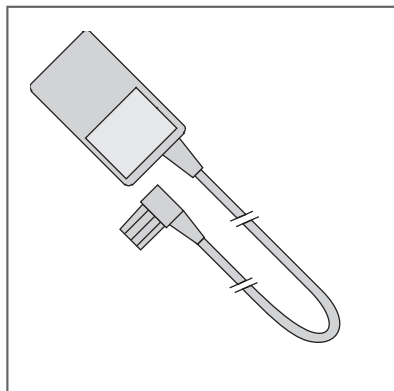

Figure 5-1 AC Adapter/Charger

EnteraLite® Infinity™ AC Adapter/Charger

Order Number INFCH01

Plug AC Adapter/Charger into a wall outlet and plug connector into pump to operate on AC power and/or recharge battery.

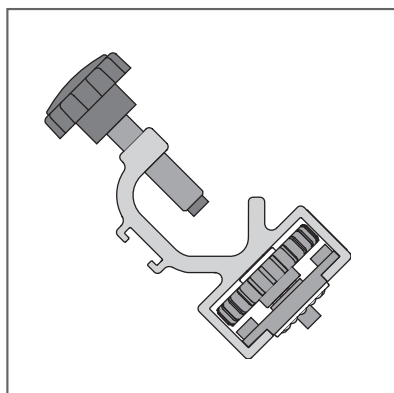

Figure 5-2 Pole Clamp

EnteraLite® Infinity™ Pole Clamp

Order Number Z-11981

Thread bolt into receptacle on the back of pump and tighten gray wheel to mount pump on clamp. If gray wheel is slightly loosened, pump can be rotated to snap into different positions. Retighten gray wheel when pump is in the desired position. Tighten black wheel to mount clamp on a pole.

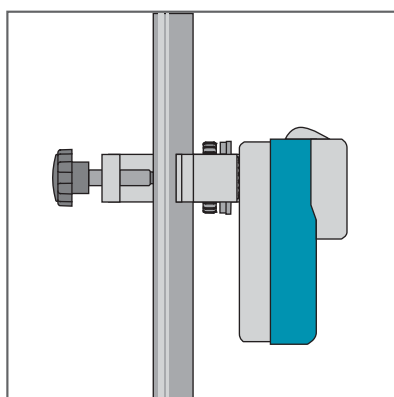

Figure 5-3 Pole Clamp with Pump Attached to IV Pole

EnteraLite® Infinity™ Mini-Backpack

Order Numbers PCK1001 (red), PCK1002 (teal)

Pack holds EnteraLite® Infinity™ with a 500 ml bag in the front section or can accommodate a 1200 ml bag in the rear section. Pump is secured with a Velcro® strap. A Velcro® strap secures the neck of the 500 ml or 1200 ml bag. The tubing is loaded into pump and any excess length of tubing can be secured with a Velcro® tab. The downstream tubing then feeds through a port at bottom of pack (either side). Also included in this pack is a pocket that may be used to hold an ice pack.



Figure 5-4 Backpack

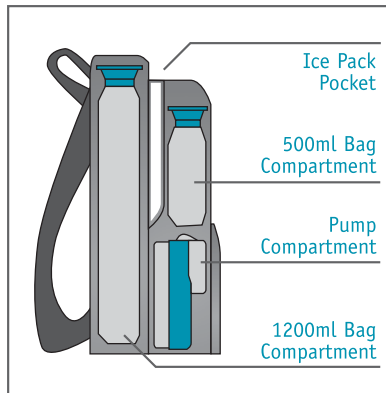

Figure 5-5 Backpack
(Cutaway View of Internal
Compartments)



Figure 5-6 Backpack
(Cutaway View of
Internal Straps)

6. SPECIFICATIONS

SIZE

Pump Dimensions: 1.95" H x 5.65" W x 4.05" D
Pump Weight: 14.4 oz (411.0 g)

BATTERY

Type: Lithium Ion
Life: 24 hours @ 125 ml/hr

Charge Time: approximately 6 hours

Charge Level Indicator Yes
Compact Wall Charger Yes

DISPLAY

Backlit LCD

OPERATING ORIENTATION

Any

FLOW RATE

Range: 0.1 - 600 ml/hr
Increment: 0.1 ml/hr from 0.1 ml/hr to 9.9 ml/hr
1 ml/hr from 10 ml/hr to 600 ml/hr
Accuracy: $\pm 5\%$

DOSE

Range: 0.1 ml to 3000 ml or infinite dose
Increment: 0.1 ml from 0.1 - 9.9 ml
1 ml from 10 - 999 ml
10 ml from 1000 - 3000 ml

VOLUME DISPLAY

Current Dose Status
Accumulated

INTERVAL FEED

Interval Feed Indication
Displays Time to Next Feed

PROGRAM MEMORY RETAINED

When Pump is on or off

PEDIATRIC USE Yes

PRIME Yes

ALARMS

| | |
|-------------|--|
| Chek | Programming error |
| Load Set | Set not loaded properly |
| Low Batt | Battery Low |
| No Flow In | Upstream occlusion -5 psi (-34 kPa) Tolerance = \pm 3psi (21 kPa) psi (pounds per square inch) kPa (kilopascals) |
| No Flow Out | Downstream occlusion, 12 psi (83 kPa) Tolerance = \pm 3psi (21 kPa) psi (pounds per square inch) kPa (kilopascals) |
| No Food | Bag is empty |
| ERRA - ERRZ | Self-test error |

DISPOSABLE SET FEATURES

Automatic Free-flow Protection
No Drip Chamber
DEHP-free

ACCESSORIES

AC Adapter/Charger
Multi-position Pole Clamp (rotatable 360°)
Multi-purpose EnteraLite® Infinity™ Carry Packs

WARRANTY

2 years

OPERATING ENVIRONMENT

Temperature: 41 °F to 104 °F (5 °C to 40 °C)
Humidity: 30% to 75% noncondensing

STORAGE ENVIRONMENT

Temperature: -4 °F to 149 °F (-20 °C to 65 °C)
Humidity: 10% to 95% noncondensing

CLASSIFICATION INFORMATION

- ▶ EnteraLite® Infinity™ Enteral Feeding Pump with internal battery – Type BF Applied Part
- ▶ EnteraLite® Infinity™ AC Adapter / Battery Charger – Class II

7. IMPORTANT PEDIATRIC CONSIDERATIONS

EnteraLite® Infinity™ can be used on pediatric patients if the specifications of pump meet delivery requirements of the patient. The specifications of primary importance are:

- ▶ The flow rate range of EnteraLite® Infinity™ is 0.1 ml/hr to 10 ml/hr in 0.1 ml/hr increments and 10 ml/hr to 600 ml/hr in 1 ml/hr increments.
- ▶ The EnteraLite® Infinity™ pump delivers the dose at the specified rate within +/- 5% volumetric flow rate accuracy under the following conditions:

NOTE: For test methodology refer to ANSI/AAMI ID26-1992 American National Standard for Infusion Devices. Reported accuracy is based upon a generic volume accuracy calculation:

$$\text{Accuracy \%} = \frac{(\text{Volume Delivered} - \text{Volume Programmed}) \times 100}{\text{Volume Programmed}}$$

- ▶▶ utilizing ZEVEX EnteraLite® Infinity™ disposable sets
- ▶▶ fluid head height at +6.0 inches ± 0.3 inches (+15.24 cm ± 0.76 cm) with respect to center of rotor.
- ▶▶ over the range of environmental operating conditions (Specified per IEC 60601-1)

Operating Temperature Range: 41 °F to 104 °F (5 °C to 40 °C)

Operating Humidity Range: 30 to 75% noncondensing

- ▶ Occlusion alarm pressure of EnteraLite® Infinity™ is 5 psi (34kPa) for upstream occlusion and 12 psi (83 kPa) for a downstream occlusion.

If these specifications meet the required feed regimen, EnteraLite® Infinity™ can be used to deliver enteral formulas to pediatric patients. ALWAYS VERIFY RATE, DOSE AND FEED INTERVAL BEFORE PROCEEDING TO FEED.

8. ADDITIONAL TECHNICAL INFORMATION

Operational Conditions

EnteraLite® Infinity™ is designed in accordance with EN 60601-1-2, EN 60601-1-4, and RTCA DO-160D standards for electromagnetic emissions and immunity. Normal operation should not interfere with nor be affected by other electronic equipment. EnteraLite® Infinity™ can safely be operated on commercial aircraft.

EnteraLite® Infinity™ Disposable Set Displacement

EnteraLite® Infinity™ Disposable Set displaces approximately 15ml of fluid when primed. Approximately 3.5 ml of air is drawn into the tubing before the enteral pump detects that bag is empty. Therefore, approximately 11.5 ml of fluid remains in the disposable set when the pump stops feeding. (These values vary by approximately 0.5 ml, depending on whether battery is low or fully charged).

Routine Maintenance

There are no user serviceable parts or routine calibration or adjustment procedures required for EnteraLite® Infinity™. All service requests should be referred to ZEVEX technical service.

9. WARRANTY

Solely for the benefit of the original buyer, ZEVEX INCORPORATED ("ZEVEX"), warrants all new EnteraLite® Infinity™ products of its manufacture to be free from defects in material and workmanship, and will replace or repair, F.O.B., at its factory in Salt Lake City, Utah, or other location designated by ZEVEX, any EnteraLite® Infinity™ products returned to it within twenty-four (24) months of original purchase by the buyer. Such repair or replacement shall be free of charge.

ZEVEX warrants to the original buyer, all repaired or replaced products to be free from defects in material and workmanship and will replace or repair such products F.O.B., at its factory in Salt Lake City, Utah, or other location designated by ZEVEX. Such repair or replacement shall carry a warranty of ninety (90) days from the date of repair or replacement or the balance of the new product warranty as described above, whichever is greater.

This Warranty applies to all EnteraLite® Infinity™ products manufactured by ZEVEX and is the ONLY WARRANTY GIVEN FOR THE SALE OF PRODUCTS OR SERVICES. NO WARRANTIES IMPLIED IN LAW, INCLUDING, BUT NOT LIMITED TO THE IMPLIED WARRANTIES OF MERCHANTABILITY AND FITNESS FOR PARTICULAR PURPOSE, SHALL APPLY. ZEVEX WILL BE LIABLE, IN ANY EVENT, ONLY FOR THE PURCHASE PRICE OF THE DEFECTIVE PRODUCT, BUT NOT FOR ANY CONSEQUENTIAL DAMAGES.

This Warranty may not be modified, amended or otherwise changed, except by a written document properly executed by a corporate officer of ZEVEX.

ZEVEX, Inc. voids the warranty if the EnteraLite® Infinity™ pump is opened or tampered with in any way without prior authorization from ZEVEX, Inc.

LIST OF FIGURES

| Figure | Description | Page |
|--------|---|------|
| 1-1 | Pump: Front | 1 |
| 1-2 | Pump: Rear | 2 |
| 1-3 | Keypad Layout | 3 |
| 1-4 | Display Segments | 4 |
| 1-5 | Alphanumeric Characters and Units | 4 |
| 1-6 | Setting Indicators | 4 |
| 1-7 | Run Indicators | 4 |
| 1-8 | Power Indicators | 4 |
| 1-9 | EnteraLite® Infinity™ 500ml or 1200ml Bag Set | 5 |
| 1-10 | EnteraLite® Infinity™ Spike Set | 5 |
| 1-11 | Symbol: Consult Accompanying Documents | 6 |
| 1-12 | Symbol: Feeding Bag Connection | 6 |
| 1-13 | Symbol: Patient Connection | 6 |
| 1-14 | Symbol: Type BF Shock Protection | 6 |
| 1-15 | Symbol: IEC 529 | 6 |
| 1-16 | Symbol: Single Patient Use | 6 |
| 1-17 | Symbol: DEHP-free | 6 |
| 2-1 | Spike Container | 7 |
| 2-2 | Fill Bag | 7 |
| 2-3 | Remove Cover from Barbed Adapter / Place Cover on Pole Clamp | 7 |
| 2-4 | Squeeze Bag | 8 |
| 2-5 | Pinch Tubing | 8 |

| Figure | Description | Page |
|--------|--|------|
| 2-6 | Tubing Segment Being Pinched | 8 |
| 2-7 | Seat Cassette | 9 |
| 2-8 | Close Pump Door | 9 |
| 2-9 | Priming Indication | 9 |
| 2-10 | Program Rate to 120 ml/hr | 10 |
| 2-11 | Program Dose to 500 ml/hr | 10 |
| 2-12 | Clear Feed Interval | 11 |
| 2-13 | Pump is Running | 11 |
| 2-14 | Amount Currently Delivered | 11 |
| 2-15 | Total Amount Delivered | 11 |
| 2-16 | DOSE DONE | 12 |
| 2-17 | Program Rate to 50 ml/hr | 14 |
| 2-18 | Program Dose to 100 ml/hr | 14 |
| 2-19 | Program Feed Interval to 6.00 hr | 14 |
| 2-20 | Pump is Running | 15 |
| 2-21 | Amount Currently Delivered | 15 |
| 2-22 | Total Amount Delivered | 15 |
| 2-23 | Time Until Next Feeding | 16 |
| 2-24 | Battery Power Indicator | 17 |
| 2-25 | Fuel Gauge | 18 |
| 2-26 | Alarm Volume Settings: BEEP LOW and BEEP HIGH | 19 |
| 2-27 | Settings Lock: UNLK and LOCK | 19 |
| 2-28 | Dose Done Settings: BEEP WHEN DONE and MUTE WHEN DONE .. | 19 |

| Figure | Description | Page |
|--------|--|------|
| 2-29 | Backlight Settings: LITE OFF and LITE ON | 19 |
| 3-1 | ERRA and ERRZ Alarm | 22 |
| 3-2 | LOAD SET Alarm | 22 |
| 3-3 | LOW BATT Alarm | 22 |
| 3-4 | NO FLOW IN Alarm | 23 |
| 3-5 | NO FLOW OUT Alarm | 23 |
| 3-6 | NO FOOD Alarm | 24 |
| 3-7 | PUSH RUN TO FEED Alarm | 25 |
| 3-8 | DOSE DONE Message | 25 |
| 3-9 | NEXT DOSE Message | 25 |
| 3-10 | CHECK Indication | 26 |
| 3-11 | TO STOP LET GO Indication | 26 |
| 3-12 | Battery Symbol and the E and F of the Fuel Gauge | 27 |
| 4-1 | Rinsing Pump Under Stream of Water | 28 |
| 5-1 | AC Adapter/Charger | 29 |
| 5-2 | Pole Clamp | 29 |
| 5-3 | Pole Clamp with Pump Attached to IV Pole | 29 |
| 5-4 | Backpack | 30 |
| 5-5 | Backpack (Cutaway View of Internal Compartments) | 30 |
| 5-6 | Backpack (Cutaway View of Internal Straps) | 30 |

WHO TO CALL

Additional Information:

YOUR HEALTHCARE PROVIDER:

YOUR PHYSICIAN:

ZEVEX Incorporated
4314 ZEVEX Park Lane
Salt Lake City, Utah 84123 USA
Customer Service and Technical Support: (800) 970-2337
www.zevex.com

INDEX

+ Key 3

- Key 3

A

AC Adapter/Charger 18, 29

Accuracy 31,34

Accessories

AC Adapter/Charger 18, 29

Backpack 30

Pole Clamp 2, 7, 29

Air Travel 36

Alarms 21

ERRA-ERRZ 22

LOAD SET 22

LOW BATT 22

NO FLOW IN 23

NO FLOW OUT 23

NO FOOD 24

PUSH RUN TO FEED 25

Alarm Volume 19

B

Battery

AC Adapter/Charger 18, 29

Battery Symbol 17

Charge Level Indicator 17, 31

Charge Time 17, 31

Charging the Battery 18, 31

Fuel Gauge 4, 18

LOW BATT Alarm 22

Power Indicator 4, 17, 18

Blockage (Occlusion) 23, 32, 34

C

Carry Packs 30

Classification Information 33

Cleaning 28

Clear Key 3

Compact Wall Charger 18, 29

D

Decrease (-) Key 3

Display

Battery Symbol 4, 18

Display Light 4

Fuel Gauge 4, 18

Run Symbol 4

Wall Plug Symbol 4, 17

Directions for Use

Loading the Set 7

Priming the Set 7

Removing Air 8

Disposable Set

500ml or 1200ml Bag 5

Adapter Protective Cover 5, 7

Cassette 5

Spike 5

Spike Protected Cover 5, 7

Stepped Enteral Adapter 5

Disposable Set Displacement 36

Dose 10, 14, 31

F

Feed Int Key 3

Feed Interval 3, 13, 25, 26, 32

Feeding Completion 12, 16

Feeding Example

Single Feeding Example 10

Interval Feeding Example 13

Flow Rate 10, 14, 31, 34

Foam 7, 24

Free-flow 33

Fuel Gauge 4, 18

I

Increase (+) Key 3

Interval Feeding Example 13

Indications

Battery Doesn't Hold Its Charge 27

Battery Doesn't Charge 27

CHEK 26

Charger Installed but No Plug
Symbol Visible 27

TO STOP LET GO 9, 26

Instructions for Use

Loading the Set 7

Priming the Set 7

Removing Air 8

K

Keypad 3

+ (Increase) Key 3

- (Decrease) Key 3

CLEAR Key 3

FEED INT Key 3, 13

ON/OFF Key 3

PRIME Key 3, 9, 26

RATE/DOSE Key 3

RUN/PAUSE Key 3

VOL/TOTAL Key 3, 11, 15

L

Less (-) Key 3

Lock Settings 19

M

Maintenance 36

Messages

DOSE DONE 12, 25

NEXT DOSE 16, 25

Mini Backpack 30

More (+) Key 3

N

Next Feeding 13, 16

O

Occlusion (Blockage) 23, 32, 34

ON/OFF Key 3

Operational Conditions 33, 36

P

Pediatric Considerations 34

Pole Clamp 2, 7, 29

Prime Feature 3, 8, 26

Prime Key 3

Priming the Set 7

Program Memory 12, 16, 32

Pump Components

Air Sensor 1

Charger/Power Connector 2

Display 1, 4

Door 1

Downstream Pressure Sensor 1

Keypad 1, 3

Pump Instruction Label 2

Pump Wheel 1

Receptacle for Cassette 1

Receptacle for Pole Clamp 2

Speaker 2

Upstream Pressure Sensor 1

R

RATE/DOSE Key 3

Rinse 28

RUN/PAUSE Key 3

S

Self Test 9

Serial Number 2, 9

Settings Lock 19

Single Feeding Example 10

Size (Pump Specifications) 31

Storage Environment 33, 36

Symbols 6

U

User Preference Settings

Alarm Volume 19

Settings Lock 19

Dose Done Alarm 19

Backlight 19

V

VOL/TOTAL Key 3

W

Water 28

Warranty 37

NOTES

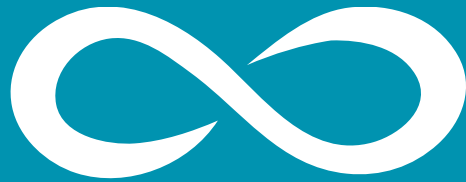

EnteraLite[®] *Infinity*[™]
ENTERAL FEEDING PUMP

OPERATOR'S MANUAL

Also available in other languages

ZEVEX[®] Incorporated

4314 ZEVEX Park Lane
Salt Lake City, UT 84123,
USA

Tel: (801) 264-1001
Toll Free: (800) 970-2337
Fax: (801) 264-1051
www.zevex.com

© 2004 ZEVEX Incorporated. U.S. Patent No's 5531680, 5733061, 6523414, 6531708, 6659976, 6623447, 6636010, 6750468. Other U.S. and foreign patents pending. Made in USA.

25356-001 Rev. 01