

FLEXIFLO QUANTUM™ Bomba enteral

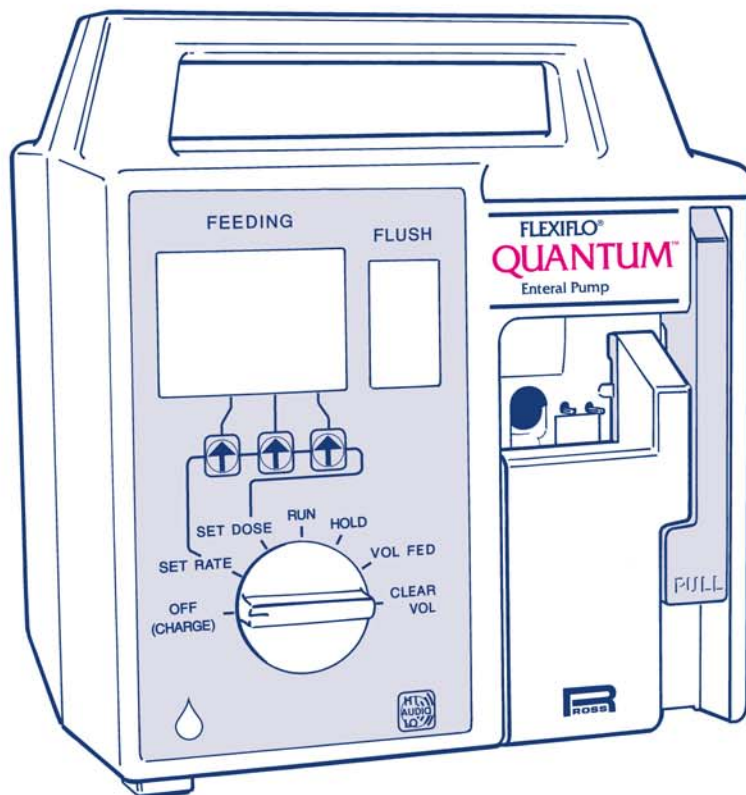

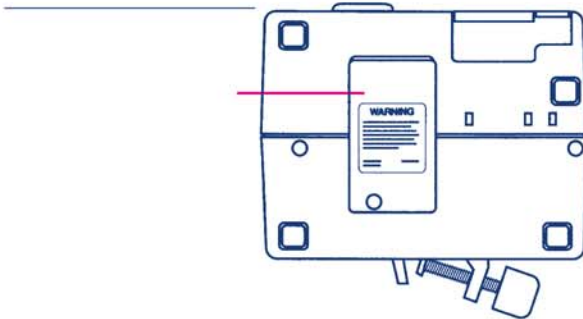

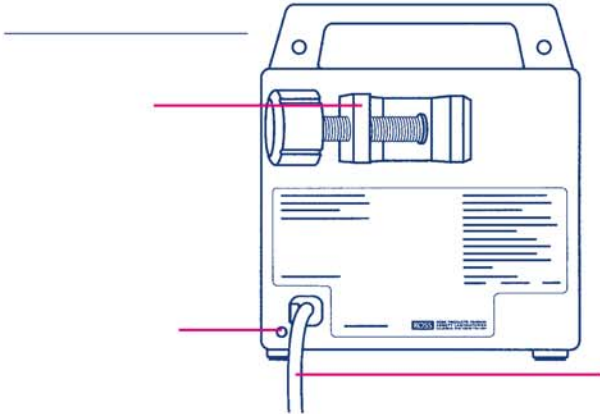

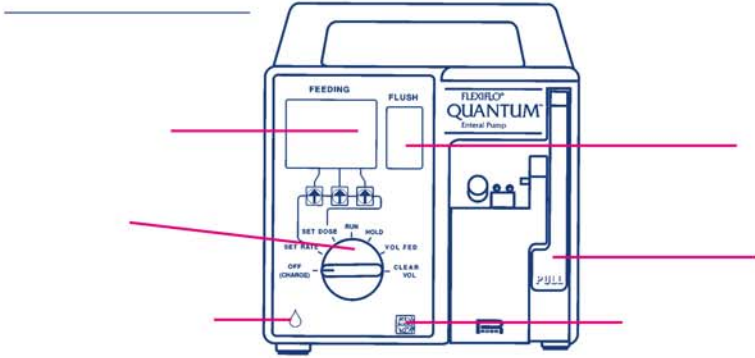
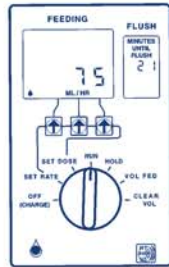
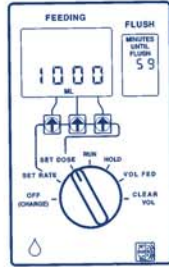
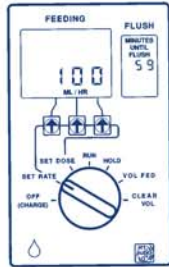
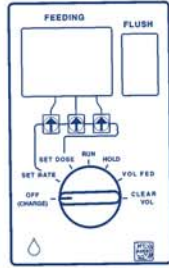
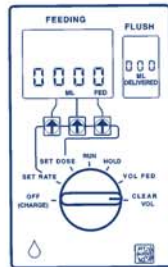
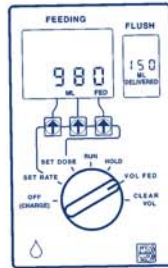
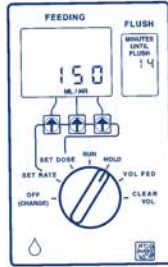

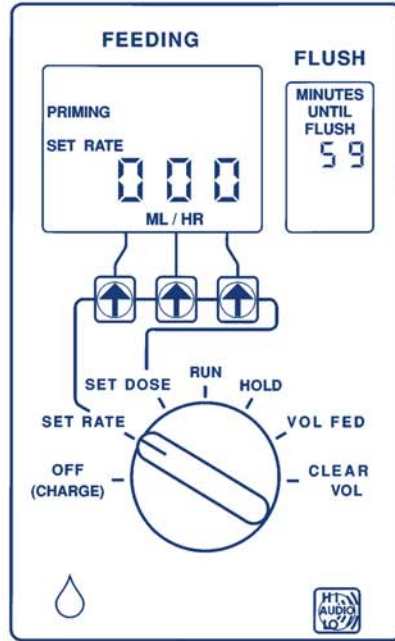
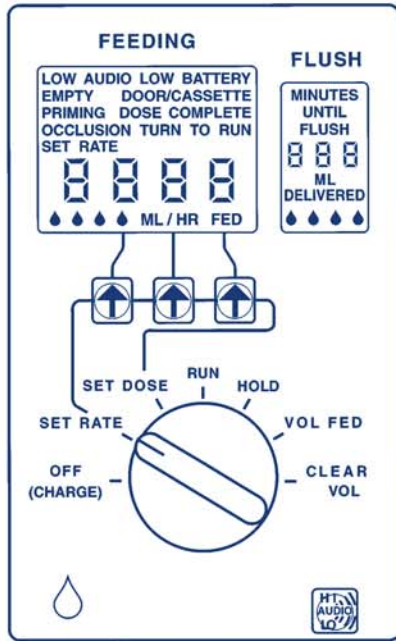

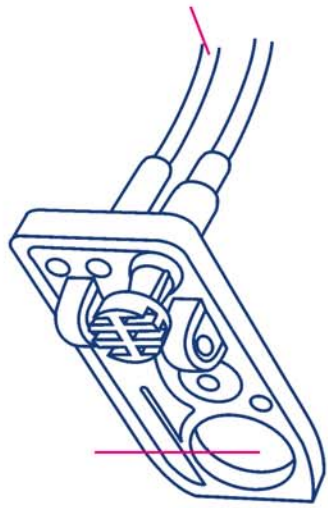

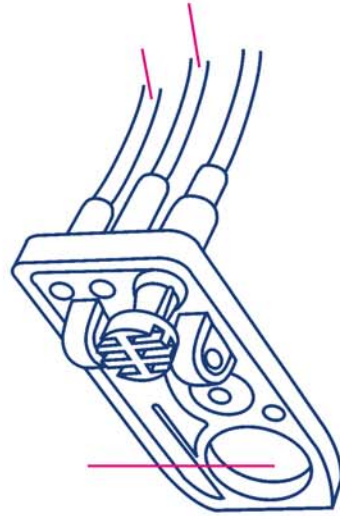
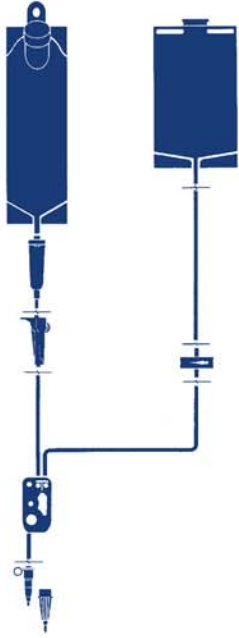

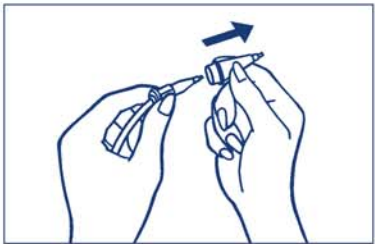
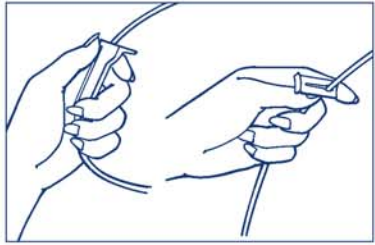
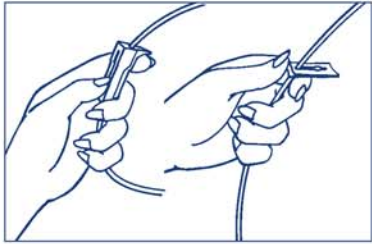

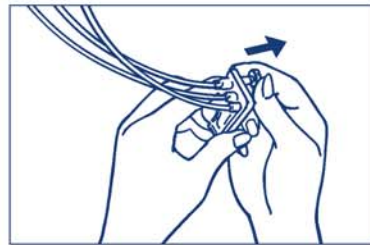
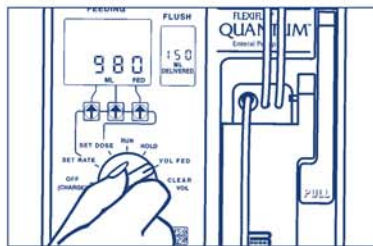
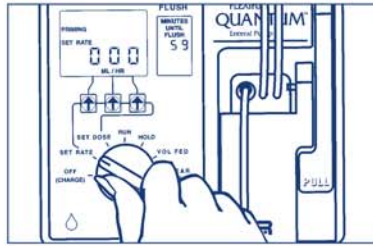

a los 30 minutos

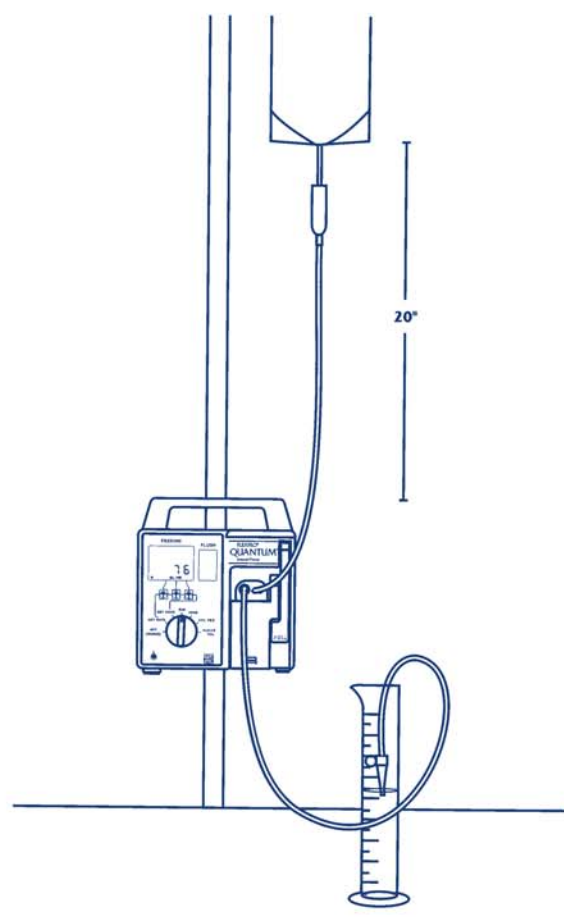

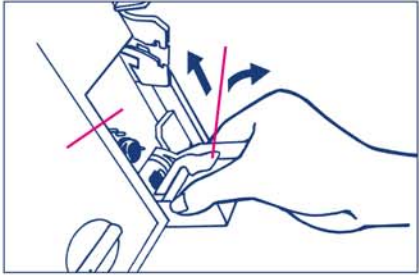
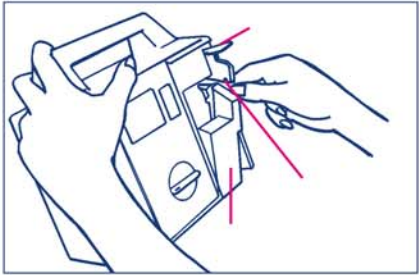
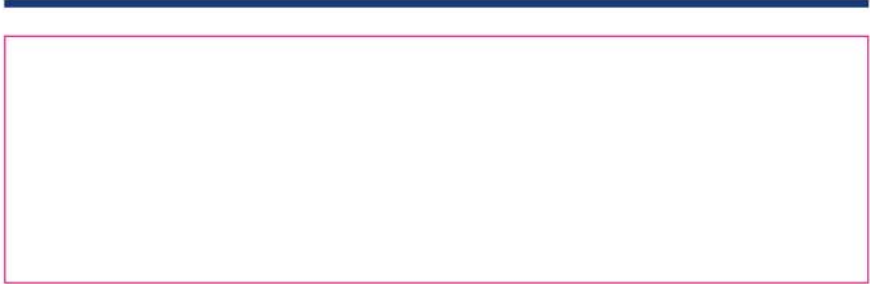





ROSS ROSS PRODUCTS DIVISION
ABBOTT LABORATORIES INC.
COLUMBUS, OHIO 43215-1724 USA