

Respironics Inc.  
1001 Murry Ridge Lane  
Murrysville, PA 15668 USA

REF 1066819  
1072847 R01  
JJB 03/10/2011



# Trilogly 100

CLINICAL MANUAL

Trilogly 100 | CLINICAL MANUAL

# Table of Contents

FOR CLINICIAN'S USE ONLY Accessing Prescription Setting Screens .....	i
Chapter 1. Introduction.....	1
Package Contents.....	1
Intended Use .....	2
Warnings and Cautions .....	3
Warnings .....	3
Cautions .....	8
Notes .....	10
Contraindications.....	11
System Overview .....	11
Symbols.....	12
Front Panel .....	12
Rear and Side Panels.....	12
How to Contact Philips Respironics .....	13
Chapter 2. System Description .....	15
Front Panel Features .....	15
Buttons .....	15
Visual Indicators .....	16
Display Screen.....	16
Side and Rear Panel Features .....	17

Chapter 3. Modes, Features, and Alarms.....	19
Therapy Modes.....	19
Breath Types.....	20
Therapy Mode Table .....	21
Pressure Control Ventilation Therapy Modes.....	22
Volume Control Ventilation Therapy Modes .....	27
Therapy Mode Features.....	30
Flex Comfort Feature .....	30
Ramp .....	31
Rise Time .....	32
AVAPS Feature.....	32
Flow Pattern Types .....	33
Sigh Feature.....	35
Dual Prescription Feature .....	35
Triggering .....	36
BTPS Compensation.....	36
Ventilator Alarms .....	37
Loss of Power Alarm.....	37
Ventilator Inoperative Alarm .....	37
Ventilator Service Required Alarm.....	37
Check Circuit Alarm .....	37
Low Circuit Leak Alarm .....	38
High Expiratory Pressure Alarm .....	38
Low Expiratory Pressure Alarm .....	38
High Internal Oxygen Alarm .....	38
Circuit Disconnect Alarm .....	38

Apnea Alarm .....	39
High Vte Alarm.....	39
Low Vte Alarm .....	39
High Vti Alarm .....	39
Low Vti Alarm .....	40
High Respiratory Rate Alarm .....	40
Low Respiratory Rate Alarm .....	40
High Inspiratory Pressure Alarm .....	40
Low Inspiratory Pressure Alarm .....	41
High Minute Ventilation Alarm .....	41
Low Minute Ventilation Alarm .....	41
Low Battery Alarm .....	42
High Temperature Alarm .....	42
Replace Detachable Battery Alarm.....	42
AC Power Disconnected Alarm.....	43
Keypad Stuck Alarm .....	43
Battery Discharging Stopped due to Temperature Info Message.....	43
Battery Not Charging due to Temperature Info Message .....	43
Battery Not Charging Info Message .....	43
Check External Battery Info Message .....	44
Battery Depleted Info Message .....	44
External Battery Disconnected Info Message.....	44
Detachable Battery Disconnected Info Message .....	44
Start On Battery Info Message .....	44
Card Error Info Message .....	44

Chapter 4. Ventilator Setup.....	45
Position the Device .....	46
Install the Air Filter .....	46
First Time Use .....	46
Supply Power to the Device.....	47
Using AC Power .....	47
Using DC Power.....	48
Device Power Source Indicators .....	50
Battery Disposal.....	52
Connect the Breathing Circuit to the Ventilator .....	53
Changing the Exhalation Porting Blocks .....	55
Connect Supplemental Oxygen (Optional) .....	57
Chapter 5. Viewing and Changing Settings.....	59
Keypad Lock Feature .....	59
Accessing the Startup and Monitor Screens .....	60
Monitor Screen Indicators .....	62
On-Screen Button Panel .....	67
Navigating the Menu Screens.....	67
Changing and Viewing Settings in Full Menu Access Mode.....	68
Changing the Device Settings and Alarms.....	69
Viewing and Changing Options Menu Items .....	79
Viewing the Alarm Log .....	82
Viewing the Event Log .....	83
Viewing Device Information .....	83
Updating Prescriptions Using the SD Card .....	84
Changing and Viewing Settings in Limited Menu Access Mode.....	87

Activating Your Primary or Secondary Prescription .....	88
Viewing and Changing My Settings Menu Items.....	89
Connecting the Ventilator to the Patient.....	91
Chapter 6. Ventilator Alarms .....	93
Audible and Visual Alarm Indicators.....	94
Alarm LED Indicators .....	94
Audible Indicators .....	95
Alarm Messages .....	96
Remote Alarm .....	98
Audio Pause and Alarm Reset Features .....	99
Audio Pause .....	99
Alarm Reset .....	99
Alarm Volume Control.....	100
What to Do When An Alarm Occurs.....	100
Alarm Summary Table.....	101
Chapter 7. Cleaning and Maintenance .....	115
Cleaning the Ventilator.....	115
Cleaning and Replacing the Air Inlet Filter.....	116
Replacing the Air Inlet Path Foam .....	117
Cleaning the Patient Circuit.....	118
Reusable Circuit Cleaning Instructions .....	118
Cleaning the Reusable Exhalation Devices.....	119
Replacing the Bacteria Filter (Optional) .....	119
Preventive Maintenance .....	120
Chapter 8. Troubleshooting.....	123

Chapter 9. Accessories.....	127
Adding a Humidifier .....	127
Adding Supplemental Oxygen to the Device .....	127
Supplemental Oxygen Warnings .....	128
Using a Remote Alarm Unit.....	128
Using a Nurse Call System .....	129
Using a Secure Digital (SD) Card .....	129
Using the Philips Respironics DirectView Software .....	130
Using the Optional In-Use Bag .....	130
Connect a Water Trap.....	130
Using an Oximetry Module (When Available).....	131
Traveling with the System .....	131
Airline Travel .....	131
Chapter 10. System Checkout Procedures .....	133
Tools Required .....	133
Visual Inspection.....	133
Initial Setup.....	134
Settings and Alarms Tests .....	134
Battery Function Verification.....	142
Alarm and Event Log Clean-Up .....	143
Results .....	144
Chapter 11. Technical Specifications .....	145
Chapter 12. Glossary .....	149
Chapter 13. EMC Information .....	155
Index .....	159
Limited Warranty .....	163

# 1. Introduction

This chapter provides an overview of the **Trilogy100** device.

## Package Contents

The **Trilogy100** system may include the following components.

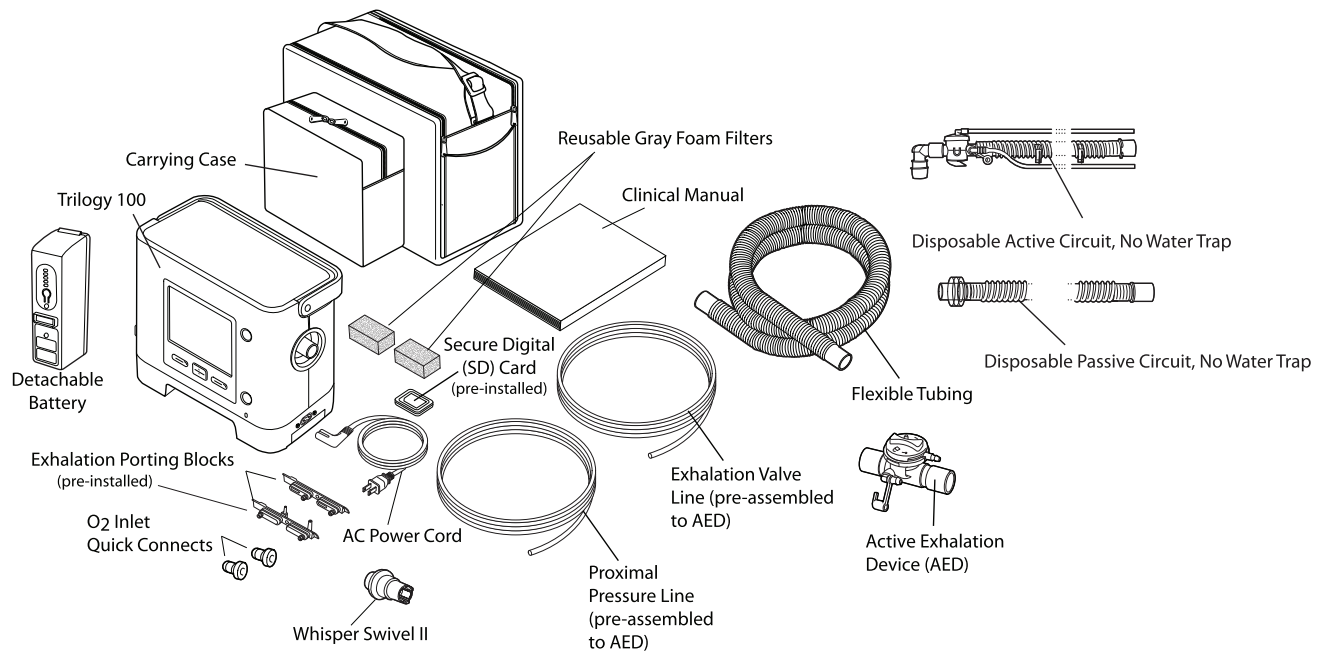

Package Contents



## Intended Use

The Philips Respironics **Trilogy100** system provides continuous or intermittent ventilatory support for the care of individuals who require mechanical ventilation. **Trilogy100** is intended for pediatric through adult patients weighing at least 5 kg (11 lbs.).

The device is intended to be used in home, institution/hospital, and portable applications such as wheelchairs and gurneys, and may be used for both invasive and non-invasive ventilation. It is not intended to be used as a transport ventilator.

The system is recommended to be used only with various combinations of Philips Respironics-approved patient circuit accessories, such as patient interface devices, humidifiers, water traps, and circuit tubing.

## Warnings and Cautions

Caution: U.S. federal law restricts this device to sale by or on the order of a physician.

### Warnings

*A warning indicates the possibility of injury to the user or operator.*

<b>Patient Monitoring</b>	<p>Prior to placing a patient on the ventilator, a clinical assessment should be performed to determine:</p> <ul style="list-style-type: none"> <li>• The device alarm settings</li> <li>• Needed alternative ventilation equipment</li> <li>• If an alternative monitor (i.e. an alarming Pulse Oximeter or Respiratory Monitor) should be used</li> </ul>
<b>Alternative Ventilation</b>	<p>For ventilator dependent patients, always have alternate ventilation equipment, such as a back-up ventilator, manual resuscitator, or similar device, available.</p>
	<p>Ventilator dependant patients should be continuously monitored by qualified personnel. These personnel should be prepared to provide alternate therapy in the event of ventilator failure or inoperative equipment.</p>
<b>Patient Disconnect Protection</b>	<p>For ventilator dependent patients, do not rely on any single alarm to detect a circuit disconnect condition. The Low Tidal Volume, Low Minute Ventilation, Low Respiratory Rate, and Apnea alarms should be used in conjunction with the Circuit Disconnect and Low Peak Inspiratory Pressure alarms.</p>
	<p>Test the operation of the circuit disconnect function daily and whenever a change is made to the patient circuit. An increase in circuit resistance can prevent proper operation of some alarms.</p>
	<p>Speaking valves, Heat Moisture Exchangers (HMEs), and filters create additional circuit resistance and may affect the performance of alarms chosen for circuit disconnect protection.</p>
	<p>Do not set the Low Peak Inspiratory Pressure alarm too low, or the system may not detect large circuit leaks or a patient disconnect.</p>

<b>Personnel Qualifications</b>	<b>Trilogy100</b> is a restricted medical device designed for use by Respiratory Therapists or other trained and qualified caregivers under the supervision of a physician.
	The prescription and other device settings should only be changed on the order of the supervising physician.
	The operator of the ventilator is responsible to read and understand this manual before use.
<b>Modes of Ventilation</b>	The device can provide therapies typically associated with both ventilator dependant and non-dependant patients. The mode of ventilation, circuit type, and alarm strategies should be chosen after a clinical evaluation of each patient's needs.
	C-Flex, Bi-Flex, and AVAPS are intended for use by adult patients.
<b>SD Card Prescription Changes</b>	When you change the device prescription, alarms, and other settings using the SD card, <b>Trilogy100</b> requires that the caregiver review and verify the changes prior to the changes being used by the device. The caregiver or health care professional is responsible to ensure that the prescription settings are correct and compatible with the patient after using this feature. Installing the wrong prescription for a particular patient may result in improper therapy, lack of appropriate safety monitoring, and risk of death or injury to the patient.
<b>Electrical Interference</b>	This device is intended for use in the electromagnetic environment specified in Chapter 13 of this manual. The user of this device should make sure it is used in a compatible environment.
	Portable and mobile RF communications equipment should be used no closer to any part of the device, including cables, than the recommended separation distance calculated using the information provided in Chapter 13 of this manual.
<b>Battery Back-up Power</b>	The internal battery is NOT intended to serve as a primary power source. It should only be used when other sources are not available or briefly when necessary; for example, when changing power sources.
	The ventilator has a two-stage low battery alarm. The medium priority alarm indicates that approximately 20 minutes of operation remain, and the high priority alarm indicates that less than 10 minutes of operation remain. Actual run time may be more or less than this and varies with battery age, environmental conditions, and therapy.
	Immediately seek an alternate power source when the "Low Battery" alarm appears. Complete power failure and loss of therapy is imminent.

<b>Operating and Storage Temperatures</b>	Do not use this device if the ambient temperature is warmer than 40° C (104° F). If the device is used at room temperatures warmer than 40° C, the temperature of the airflow may exceed 43° C (109° F). This could cause system alarms, thermal irritation, or injury to the patient's airway.
<b>Bacteria Filter</b>	Philips Respironics recommends that a main line outlet bacteria filter (Part Number 342077) be used whenever the device is used for invasive therapy or if the ventilator may be used on multiple patients.
<b>Patient Circuits (General)</b>	The ventilator should only be used with patient interfaces (e.g., masks, circuits and exhalation ports) recommended by Philips Respironics. Proper operation of the device, including alarms, with other circuits has not been verified by Philips Respironics and is the responsibility of the health care professional or respiratory therapist.
	When adding any components to the breathing system, the flow resistance and dead space of the added components such as humidifiers, speaking valves, Heat Moisture Exchangers (HMEs) and filters should be carefully considered in relation to the potential for adverse effects on the patient's ventilatory management and device alarms.
<b>Passive Circuits</b>	An exhalation port is required when using a passive circuit.
	For the passive circuit, at low expiratory pressures, the flow through the exhalation port may be inadequate to clear all exhaled gas from the tubing – some rebreathing may occur. Rebreathing of exhaled air for longer than several minutes can in some circumstances lead to suffocation.
<b>Active Circuits</b>	Only use the active exhalation device designed for <b>Trilogy100</b> . Philips Respironics has not verified proper operation of other active exhalation devices, and their use may result in improper or unsafe device operation.
	With the active patient circuit, the exhalation device must be operating properly for the ventilator to deliver therapy. The exhalation device should be inspected on a daily basis and replaced whenever necessary.

<b>System Checkout</b>	Do not use the ventilator on a patient until a system checkout has been performed. See Chapter 10 of this manual.
	To make sure the device is operating properly at start-up, always verify that the audible tone sounds and the alarm LEDs light red and then yellow momentarily. Contact Philips Respironics or an authorized service center for service if these indications do not occur at start-up.
<b>Remote Alarms</b>	<p>When using a remote alarm, make sure you fully test the remote alarm connector and cable by verifying that:</p> <ul style="list-style-type: none"> <li>– Annunciated alarms on the ventilator are also annunciated on the remote alarm.</li> <li>– Disconnecting the remote alarm cable from the ventilator or from the remote alarm results in an alarm notification at the remote alarm.</li> </ul>
	The remote alarm should be tested daily.

<b>Oxygen</b>	When administering fixed-flow supplemental oxygen, the oxygen concentration may not be constant. The inspired oxygen concentration will vary, depending on the pressures, patient flows and circuit leak. Substantial leaks may reduce the inspired oxygen concentration to less than the expected value. Appropriate patient monitoring should be used, as medically indicated, such as an alarming pulse oximeter.
	This device DOES NOT alarm for loss of the low flow oxygen supply.
	This device is intended to be connected to a low flow (0-15 l/min) oxygen source such as an oxygen concentrator or other oxygen source equipped with a pressure regulator (set to 50 PSI or less) and a flow regulator/meter.
	Do not connect the device to an unregulated or high pressure oxygen source.
	The device may result in incorrect flow and tidal volume measurements and improper operation of related alarms if you add low flow oxygen directly into the patient circuit or mask instead of using the oxygen inlet on the back of the ventilator.
	Oxygen supports combustion. Oxygen should not be used while smoking or in the presence of an open flame.
	If oxygen is used with the device, the oxygen flow must be turned off when the device is not in use. <b>Explanation of the Warning:</b> When the device is not in operation and the oxygen flow is left on, oxygen delivered into the tubing may accumulate within the device's enclosure.
<b>Fire or Explosion</b>	The ventilator should not be operated in the presence of flammable gasses. This could cause a fire or explosion.

<b>Alarms</b>	Respond immediately to any alarm. It may indicate a potentially life-threatening condition. Refer to the Alarms and Troubleshooting chapters for more information.
	Visually monitor the patient and ventilator at all times during an Alarm Silence period. Allowing alarms to continue without intervention may result in harm to the patient.
	If the high priority "Low Internal Battery" message appears, immediately connect the ventilator to an alternate power source. If no alternate power source is available, immediately place the patient on an alternate source of ventilation.
	If the "Ventilator Inoperable" alarm occurs, immediately place the patient on an alternate source of ventilation.
	You should not rely on any single alarm to detect a circuit disconnect condition. The Low Tidal Volume, Low Minute Ventilation, Low Respiratory Rate, and Apnea alarms should be used in conjunction with the Circuit Disconnect alarm.
	Make sure the alarm volume is set loud enough to be heard by the caregiver. Consider the use of a remote alarm.
	<p><b>Trilogy100</b> offers the following circuit types:</p> <ul style="list-style-type: none"> <li>• Passive</li> <li>• Active PAP</li> </ul> <p>The Passive circuit type provides an ESTIMATE of Vte.</p> <p>The Active PAP circuit type DOES NOT measure Vte and only provides for an indication of the delivered tidal volume (Vti).</p>
<b>Improperly Functioning Ventilator</b>	If you notice any unexplained changes in the performance of the device, if it is making unusual sounds, if the device or detachable battery are dropped, if water is spilled into the enclosure, or if the enclosure is cracked or broken, discontinue use and contact Philips Respironics or an authorized service center for service.

<b>Maintenance</b>	Follow the service recommendations provided in chapter 7 of this manual.
	Periodically inspect electrical cords, cables, and the detachable battery pack for damage or signs of wear. Discontinue use and replace if damaged.
	Repairs and adjustments must be performed by Philips Respironics-authorized service personnel only. Unauthorized service could cause death or injury, invalidate the warranty, or result in costly device damage.
<b>Cleaning</b> (Refer to Chapter 7 for detailed cleaning instructions.)	To avoid electrical shock, always unplug the power cord from the wall outlet before cleaning the ventilator.
	Do not immerse the device in any fluids or spray the device with water or cleaners. Clean the device with a cloth dampened with an approved cleaner.
	If the device has been exposed to rain or dampness, dry the device including the area around the power cord connection with the power cord disconnected from the device before applying AC power.

## Cautions

*A caution indicates the possibility of damage to the device.*

<b>Storage</b>	The internal and detachable batteries will self-discharge in storage. If it is desired to keep the batteries fully charged (for example, as a back-up ventilator), plug the device into AC power for about eight hours every 16 days. Alternatively, the ventilator may be left continuously connected to AC power without battery degradation.
	Allowing the batteries to fully discharge will not harm the batteries or lose device settings, but may require a longer battery charge time prior to use.



<b>Operating and Storage Temperatures</b>	The device may only be operated at temperatures between 5° C and 40° C (41° F and 104° F).
	Do not operate the device in direct sunlight or near a heating appliance because these conditions can increase the temperature of the airflow delivered to the patient.
	Prolonged operation or storage at elevated temperatures may reduce the service life of the battery and other internal components of the ventilator.
	The ventilator has an internal and detachable Lithium-Ion Battery. Do not expose the device or detachable battery to temperatures above 40° C (104° F) during use, or above 60° C (140° F) during storage. This will reduce battery life and may increase the risk of fire or damage the battery.
<b>Condensation</b>	Condensation may affect operation or accuracy of the device. If the device has been exposed to either very hot or very cold temperatures during storage, allow it to adjust to ambient temperature before starting therapy.
<b>Air Filter</b>	The reusable foam inlet filter is required to protect the ventilator from dirt and dust. Wash periodically and replace when damaged for proper operation.
<b>Cooling Air Vents</b>	Do not block the cooling air vents located on the base and the rear of the device. This may cause the device to overheat in high ambient temperatures or at high therapy settings.
<b>Battery Life</b>	The internal and detachable batteries wear out based on the amount of use (hours or full charge-discharge cycles). The battery capacity and life are also reduced by operation at higher temperatures.
<b>Detachables Battery</b>	Only use the Philips Respironics Trilogy Detachable Battery with the ventilator.

<b>Cleaning</b>	Do not steam autoclave the ventilator. Doing so will destroy the ventilator.
	Do not immerse the device in liquid or allow any liquid to enter the enclosure or inlet filter.
	Do not spray water or any other solutions directly onto the ventilator.
	Do not use harsh detergents, abrasive cleaners, or brushes to clean the ventilator system. Use only cleaning agents and methods listed in this manual.
<b>Patient Circuit</b>	Exhalation valves, patient circuits, and water traps are shipped clean, not sterile. Cleaning and disinfection of these parts should follow individual institution processes and conform to guidelines provided by Philips Respironics with each accessory.
<b>External DC Power</b>	Do not use the same external battery to operate both the ventilator and any other equipment such as power chairs.
	An external battery should only be connected to the ventilator using the Philips Respironics Trilogy External Battery Cable. This cable is fused, pre-wired, and properly terminated to ensure safe connection to a standard deep-cycle, lead acid battery. Use of any other adapter or cable may cause improper operation of the ventilator.
	The ventilator should only be connected to an automotive electrical system using the Philips Respironics Trilogy Automotive Adapter (when available). This adapter is fused, filtered, and designed for safe connection to a standard automotive electrical system. Use of any other adapter or cable may cause improper operation of the ventilator.
	Do not operate the ventilator from a car electrical system when starting the vehicle or jump-starting the vehicle. Electrical transients during starting may cause improper operation of the ventilator.
<b>Electrostatic Discharge (ESD)</b>	Do not use antistatic or conductive hoses or conductive patient tubing with the device.

## Notes

- This product does not contain natural latex rubber or dry natural rubber in patient or operator accessible areas or in the air path or breathing circuit.

## Contraindications

If the patient has any of the following conditions, consult their health care professional before using the device in a non-invasive mode:

- Inability to maintain a patent airway or adequately clear secretions
- At risk for aspiration of gastric contents
- Diagnosed with acute sinusitis or otitis media
- Epistaxis, causing pulmonary aspiration of blood
- Hypotension

## System Overview

This ventilator provides both pressure control and volume modes of therapy. The device can provide non-invasive or invasive ventilation. It can be used to provide total therapy to patients as they progress from non-invasive to invasive ventilation.



When prescribed, the device provides numerous special features to help make patient therapy more comfortable. For example, the ramp function allows you to lower the pressure when trying to fall asleep. The air pressure will gradually increase until the prescription pressure is reached. Additionally, the Flex comfort feature provides increased pressure relief during the expiratory phase of breathing.

The ventilator can be operated using several different power sources, including an internal Lithium-Ion battery. This battery is automatically used when the detachable Lithium-Ion battery pack, external Lead Acid battery, or AC power are not available.







## Symbols

The following symbols appear on the device.

### Front Panel

Symbol	Description
	Therapy Start/Stop
	Alarm Indicator/Audio Pause
	AC Power Indicator

### Rear and Side Panels

Symbol	Description
	AC Power Connector
	Secure Digital (SD) Card Slot
<b>IOIOI</b>	Serial Port Connector
	Remote Alarm Connector
	DC Power Connector
<b>O<sub>2</sub></b>	Oxygen Inlet
	Consult accompanying instructions for use.
	Type BF Applied Part
	Class II (Double Insulated)

<p><b>IPX1</b></p> 	<p>Drip Proof Equipment</p> <p>For Airline Use. Complies with RTCA-D0160F section 21, category M.</p>
--	---

## How to Contact Philips Respironics

To have your device serviced, contact Philips Respironics Customer Service department at 1-724-387-4000 or 1-800-345-6443.

Respironics Inc.  
1001 Murry Ridge Lane  
Murrysville, PA 15668 USA



## 2. System Description

This chapter describes the front and rear panel device controls and features.

### Front Panel Features

The front panel contains the control buttons, visual indicators, and display screen.

#### Buttons

The following buttons are included on the front panel of the device.

1.  **Start/Stop Button**

This button turns the airflow on or off, starting or stopping therapy.

2.  **Alarm Indicator and Audio Pause Button**

This button serves two purposes: it temporarily silences the audible portion of an alarm, and it also acts as an alarm indicator. When silencing an alarm, if the cause of the alarm is not corrected, the alarm sounds again after one minute. Each time the button is pressed, the alarm silence period resets to one minute. See Chapter 6 for more information.

3.  **Up/Down Button**

This button allows you to navigate the display menu and edit device settings.

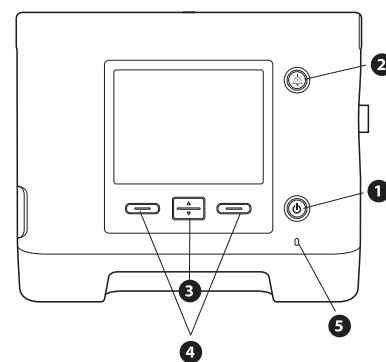

#### Front Panel Controls and Display Screen

**Note:** When you start therapy, the display backlight and the backlights on the buttons turn on, the red and yellow alarm LEDs turn on momentarily, and an audible indicator sounds to indicate that therapy has started. The Startup screen appears on the display.



#### WARNING

To make sure the device is operating properly at start-up, always verify that the audible tone sounds and the alarm LEDs light red and then yellow momentarily. Contact Philips Respironics or an authorized service center for service if these indications do not occur at start-up.

#### 4. **Left and Right Buttons**

These buttons allow you to select display options or perform certain actions specified on-screen.

### Visual Indicators

Several power and alarm indicators appear on the front panel.

#### 5. **AC Power LED**

In the lower right corner of the front panel, a green LED (~) indicates that AC power is applied to the device. This light remains on as long as adequate AC power is available.

#### 6. **Keypad Backlight LEDs**

The Start/Stop, Up/Down, and Left/Right buttons all have a white LED that lights up if the keypad backlight is turned on in the device Options menu. See Chapter 5 for more information.

#### 7. **Red Alarm LED**

On the Alarm Indicator/Audio Pause button, a red light flashes to indicate a high priority alarm.

#### 8. **Yellow Alarm LED**

On the Alarm Indicator/Audio Pause button, a yellow light flashes to indicate a medium priority alarm. A solid yellow light indicates a low priority alarm.

***Note:** See Chapter 6 for more information about high, medium, and low priority alarms.*

### Display Screen

The display screen allows you to view settings, system status information, real-time patient data, alarms, and logs. You can also modify certain settings on the display screen.

See Chapter 5 for more information on viewing and modifying device settings.

## Side and Rear Panel Features

The ventilator's side and rear panels contain the following connectors and features, shown at right.

### 1. AC Power Inlet

You can plug the AC power cord into this connector, located on the right side of the ventilator.

### 2. Breathing Circuit Connection

The breathing circuit connector is located on the right side of the device. You can connect your circuit tubing system here. See Chapter 4 for details.

### 3. Exhalation Porting Block

The porting block used here depends on the type of exhalation device you are using. The Passive Exhalation Porting Block is shown here. See Chapter 4 for more information.

### 4. Secure Digital (SD) Data Card Slot

On the left side of the device is a slot for the optional SD Card. You can have the patient record usage and therapy information from the device on the SD card.

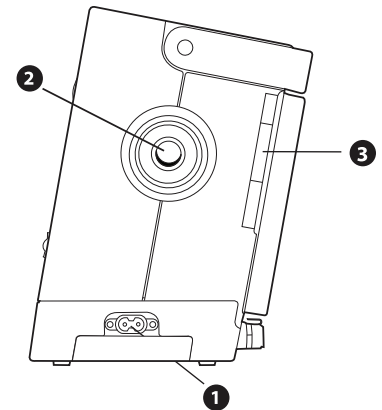

Right Side Panel

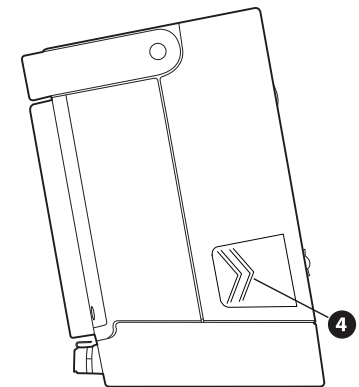

Left Side Panel



## 5. Serial Connector

You can use this connector to connect the device to a computer running PC Direct or Sleepware software or to other Philips Respironics accessories. Use the Trilogy RS232 Serial Cable to connect the ventilator to the external device or computer.

## 6. Remote Alarm/Nurse Call Connector

If you are using an optional remote alarm or nurse call system with the ventilator, you can connect the Philips Respironics remote alarm adapter cable or nurse call adapter cable to this connector.

## 7. External Battery Connector (DC Power Inlet)

You can connect an external, stand-alone lead acid battery here, using the Trilogy External Battery cable.

## 8. Oxygen (O<sub>2</sub>) Inlet Connector

If using low flow supplemental oxygen, connect the oxygen source to this connector using one of the O<sub>2</sub> Inlet Quick Connects provided with the device.

## 9. Air Inlet and Filter

Insert the filter supplied with the device into the air inlet.

## 10. Detachable Battery Pack Slot

If you are using the Philips Respironics Lithium-Ion detachable battery pack to power the device, attach it here.

## 11. Cord Retainer

Secure the power cord using the cord retainer to prevent someone from accidentally disconnecting the power cord. See Chapter 4 for more information.

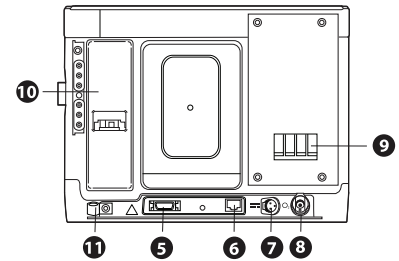

Rear Panel

## 3. Modes, Features, and Alarms

### Therapy Modes

The device provides Pressure Control Ventilation (PCV) and Volume Control Ventilation (VCV) for non-invasive and invasive patients.

Pressure Control ventilation delivers a prescribed pressure to the patient according to set breath rate and set inspiration time parameters. This means that each breath is controlled so that a prescribed amount of pressure is delivered to the patient. The device offers six different Pressure Control modes of operation:

- CPAP – Continuous Positive Airway Pressure
- S – Spontaneous Ventilation
- S/T – Spontaneous/Timed Ventilation
- T – Timed Ventilation
- PC – Pressure Control Ventilation
- PC-SIMV – Pressure Controlled Synchronized Intermittent Mandatory Ventilation

Volume Control ventilation delivers a prescribed inspired tidal volume to the patient according to set breath rate and set inspiratory time parameters. This means that each breath is controlled so that a prescribed tidal volume is delivered to the patient. The device offers three different Volume Control modes of operation:

- AC – Assist Control Ventilation
- CV – Control Ventilation
- SIMV – Synchronized Intermittent Mandatory Ventilation

## Breath Types

There are four breath types that apply to the Volume Control and Pressure Control ventilation therapy modes:

- Spontaneous
- Mandatory
- Assisted
- Sigh

### Spontaneous Breath

A Spontaneous breath is triggered by the patient. Breaths are initiated by the patient's inhalation effort, and air delivery is controlled based on the current pressure or volume setting. Breaths are terminated by either the ventilator settings or by the patient's exhalation effort, depending on the mode selected.

### Mandatory Breath

A Mandatory breath (or machine breath) is completely controlled by the ventilator. The ventilator controls both the beginning (triggering) and end (cycling) of the inspiratory phase.

### Assisted Breath

An Assisted breath is controlled by both the patient and the ventilator. Breaths are initiated by the patient's effort and air delivery is controlled by the current pressure or volume settings. Volume Assisted breaths will deliver the prescribed Tidal Volume within the prescribed Inspiratory Time. Pressure Assisted breaths will deliver the prescribed Inspiratory Pressure for the prescribed Inspiratory Time. Breaths are terminated when the Inspiratory Time setting has been reached.

### Sigh

A Sigh breath is a breath where 150% of the prescribed volume is delivered. The device will deliver this breath once every 100 Mandatory or Assist breaths when the Sigh setting is enabled. Sigh breaths are only available in volume modes of ventilation.

## Therapy Mode Table

The following table summarizes all of the therapy modes and the settings available in each mode. Some settings in the table are dependent upon other settings. For instance, if Trigger Type is set to Flow Trigger, then the Flow Trigger Sensitivity and Flow Cycle settings will display.

*Note: Pressure Support, referred to in the table below and later in this manual, is defined as IPAP - EPAP or Pressure - PEEP (PC-SIMV).*

		Therapy Modes								
		CPAP	S	S/T	T	PC	PC-SIMV	CV	AC	SIMV
<b>Therapy Parameters</b>	Dual Prescription	√	√	√	√	√	√	√	√	√
	Circuit Type	√	√	√	√	√	√	√	√	√
	CPAP	√								
	IPAP		√	√	√	√				
	AVAPS (On, Off)*		√	√	√	√				
	IPAP Max Pressure		√	√	√	√				
	IPAP Min Pressure		√	√	√	√				
	EPAP		√	√	√	√				
	Inspiratory Pressure						√			
	Pressure Support (PS)						√			√
	PEEP						√	√	√	√
	Tidal Volume		√	√	√	√		√	√	√
	Breath Rate			√	√	√	√	√	√	√
	Inspiratory Time			√	√	√	√	√	√	√
	Trigger Type*		√	√		√	√		√	√
	Flow Trigger Sensitivity	√	√	√		√	√		√	√
	Flow Cycle Sensitivity	√	√	√			√			√
	Ramp Length	√	√	√	√	√				
	Ramp Start Pressure	√	√	√	√	√				
	Flex *	√	√							
	Rise Time		√	√	√	√	√			√
	Flow Pattern							√	√	√
	Sigh							√	√	√
	Circuit Disconnect	√	√	√	√	√	√	√	√	√
	Apnea	√	√	√		√	√		√	√
	Apnea Rate		√	√		√	√		√	√
	High Vte*	√	√	√	√	√	√	√	√	√
	Low Vte*	√	√	√	√	√	√	√	√	√
	High Vti*	√	√	√	√	√	√	√	√	√
	Low Vti*	√	√	√	√	√	√	√	√	√
	High Minute Ventilation	√	√	√	√	√	√	√	√	√
	Low Minute Ventilation	√	√	√	√	√	√	√	√	√
High Respiratory Rate	√	√	√	√	√	√	√	√	√	
Low Respiratory Rate	√	√	√	√	√	√	√	√	√	
High Inspiratory Pressure							√	√	√	
Low Inspiratory Pressure							√	√	√	

\* AVAPS, Trigger Type, Flex, High Vte and Low Vte settings are only available with the Passive circuit type. Trigger Type is not available with the Passive circuit in CPAP mode. High Vti and Low Vti settings are only available with the Active circuit with PAP.

## Pressure Control Ventilation Therapy Modes

Pressure Control ventilation modes deliver a prescribed pressure to the patient.

### Continuous Positive Airway Pressure (CPAP) Mode

In the Continuous Positive Airway Pressure (CPAP) mode, the device delivers a continuous pressure to the patient at all times. All breaths in this mode are Spontaneous breaths.

### Spontaneous (S) Mode

In Spontaneous (S) mode, the device delivers bi-level pressure support. This mode provides only spontaneous breaths. In this mode, an Inspiratory Positive Airway Pressure (IPAP) is delivered during inhalation and a lower Expiratory Positive Airway Pressure (EPAP) is delivered during exhalation. The following illustration describes these concepts.

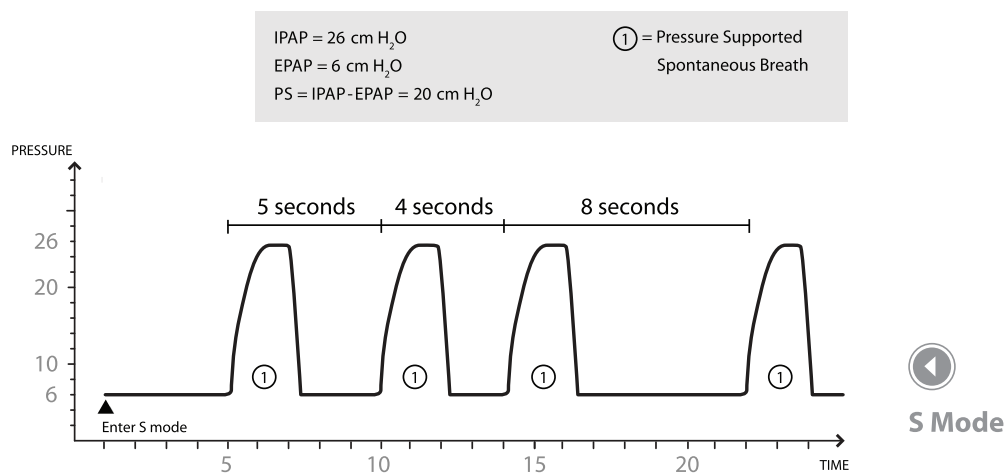

## Spontaneous/Timed (S/T) Mode

In Spontaneous/Timed (S/T) mode, the device delivers bi-level pressure support. This mode provides Spontaneous and Mandatory breaths. A Mandatory breath is delivered if the patient does not spontaneously breathe within the prescribed Breath Rate (BPM) setting. This ensures that the patient receives a minimum number of breaths per minute. In this mode, an IPAP is delivered during inhalation and a lower EPAP is delivered during exhalation. The duration of a Spontaneous breath is determined by the patient effort. The duration of a Mandatory breath is determined by the inspiratory time setting. The following illustration describes these concepts.

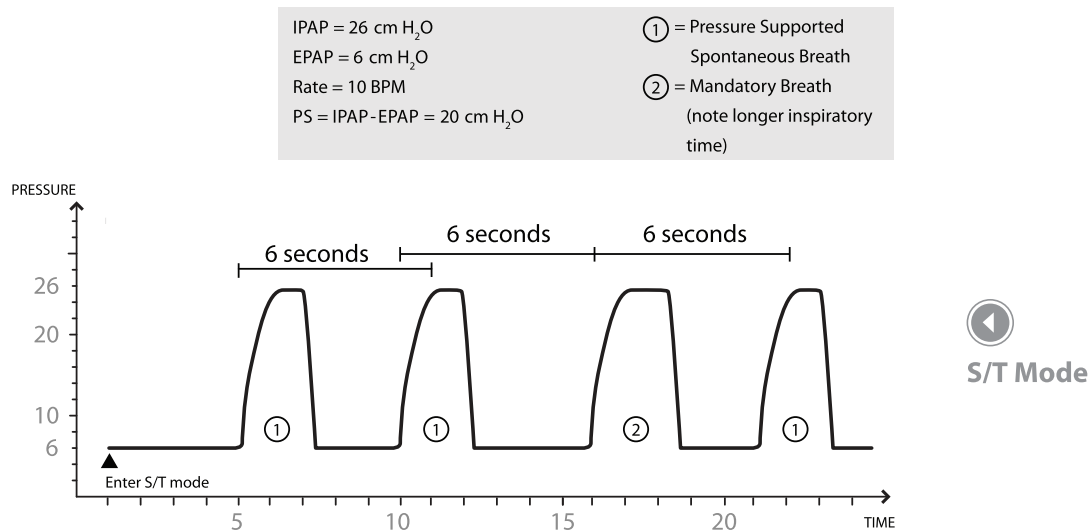

## Timed (T) Mode

In Timed (T) mode, the device delivers bi-level pressure support. This mode delivers Mandatory breaths only. A Mandatory breath is delivered according to the prescribed BPM and inspiratory time settings. This also means that the ventilator will not respond to patient effort. In this mode, an IPAP is delivered during inhalation and a lower EPAP is delivered during exhalation. The following illustration describes these concepts.

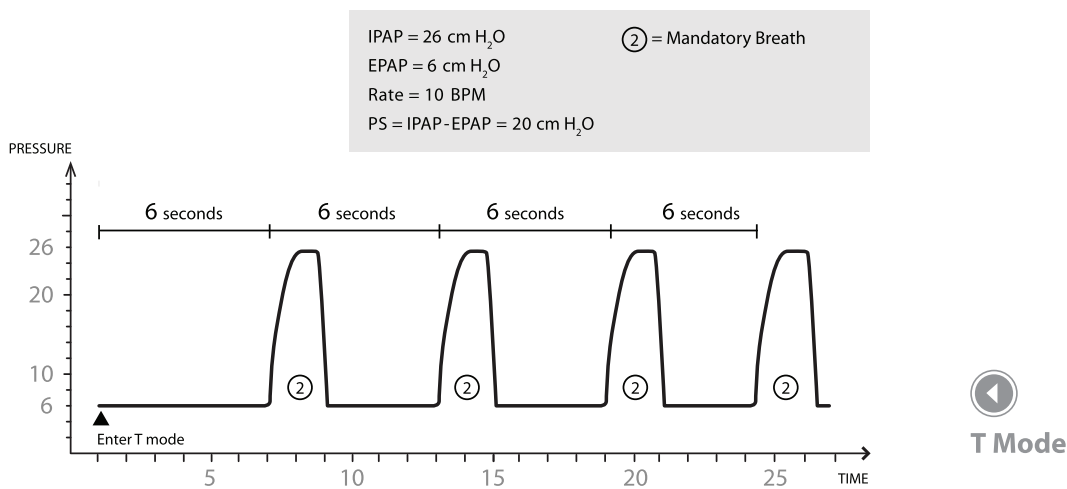

## Pressure Control (PC) Mode

In Pressure Control (PC) mode, the device delivers bi-level pressure support. This mode delivers Assist and Mandatory breaths. This mode is identical to S/T mode, except that all breaths have a fixed inspiratory time.

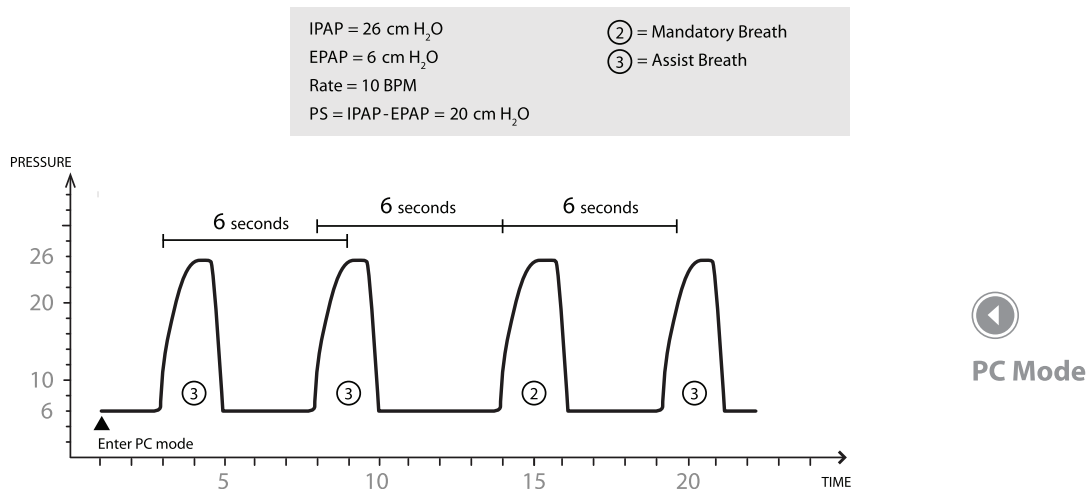

## Pressure Control - Synchronized Intermittent Mandatory Ventilation (PC-SIMV) Mode

The Pressure Control – Synchronized Intermittent Mandatory Ventilation (PC-SIMV) mode provides Spontaneous, Assist, and Mandatory breaths. This mode uses a time window to decide what type of breaths should be delivered.

When you enter PC-SIMV mode, the time window is started. If the patient does not trigger a breath, the ventilator will provide a Mandatory breath when the time expires and then begin the process again. Mandatory breaths deliver the Inspiratory Pressure setting during inhalation and a lower Peak End Expiratory Pressure (PEEP) during exhalation (not PEEP compensated).



During the time window, if patient effort is detected, either a Spontaneous or an Assist breath is delivered for the first effort. If the last breath delivered was Mandatory, then a Spontaneous breath is delivered for the first patient effort of the window. If the last breath delivered was an Assist or Spontaneous breath, then an Assist breath is delivered for the first patient effort of the window. Assist breaths deliver the Inspiratory Pressure setting during inhalation and the PEEP setting during exhalation. Pressure supported spontaneous breaths are delivered above the PEEP setting (PEEP compensated).

During the time window, if patient effort continues to be detected (after the first patient triggered breath), Spontaneous breaths are delivered for the remainder of the window. The figure below provides example breath patterns in PC-SIMV mode.

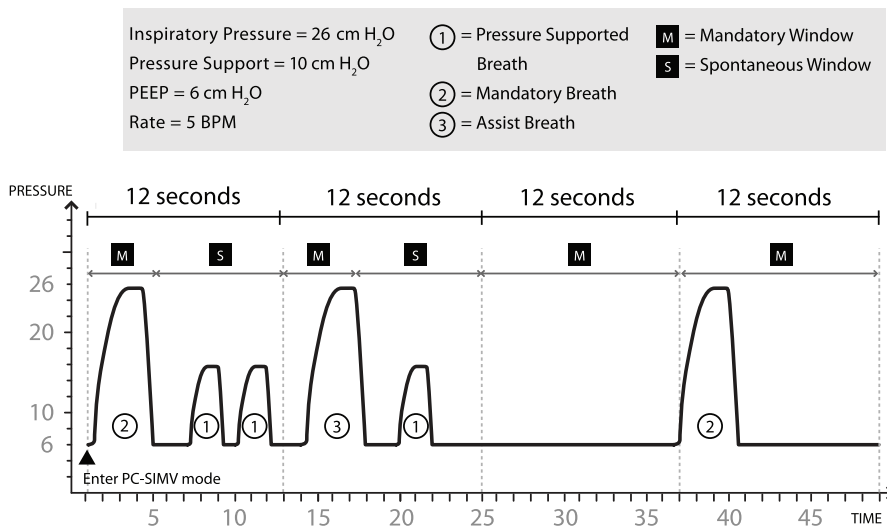

Sample Breath Patterns in PC-SIMV Mode

## Volume Control Ventilation Therapy Modes

Volume Control ventilation modes deliver a prescribed inspired tidal volume according to a set Breath Rate and a set Inspiratory Time.

### Control Ventilation (CV) Mode

In Control Ventilation (CV) mode, the device delivers volume control therapy. This mode provides only Mandatory breaths. A Mandatory breath is delivered according to the prescribed BPM setting for the prescribed Inspiratory Time. This also means that the ventilator will not respond to patient effort. In this mode, the Tidal Volume is delivered during inhalation and PEEP is delivered during exhalation. The following illustration describes these concepts.

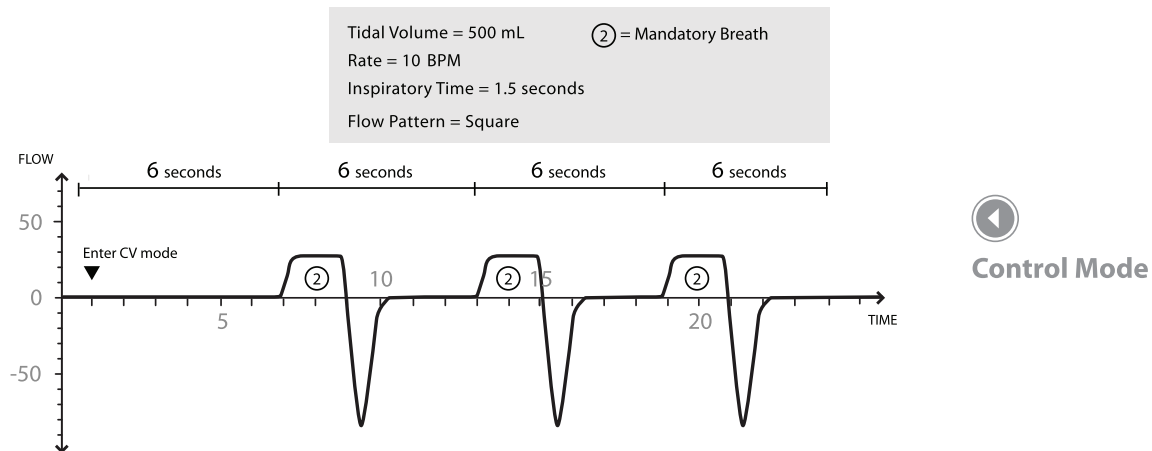

## Assist Control (AC) Mode

In Assist Control (AC) mode, the device delivers volume control therapy. This mode provides Assist and Mandatory breaths. An Assist breath is started when there is patient effort, but it is ended when the Inspiratory Time setting has been met. A Mandatory breath is delivered if the patient does not spontaneously breathe within the prescribed BPM setting. This ensures that the patient receives a minimum number of breaths per minute. In this mode, the Tidal Volume is delivered during inhalation and PEEP is delivered during exhalation. The following illustration describes these concepts.

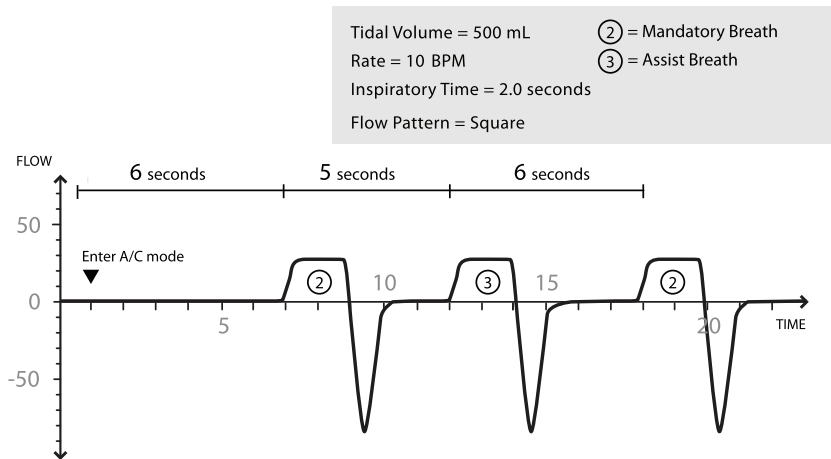

Assist Control Mode

## Synchronized Intermittent Mandatory Ventilation (SIMV) Mode

In Synchronized Intermittent Mandatory Ventilation (SIMV) mode, the device delivers both volume control and pressure control therapy. This mode provides Spontaneous, Assist, and Mandatory breaths. This mode uses a time window to decide what type of breaths should be delivered.

When you enter SIMV mode, the time window is started. If the patient does not provide any effort, the ventilator will provide a Mandatory Volume breath when the time expires and then begin the process again. Mandatory breaths deliver the Tidal Volume setting during inhalation and provide a lower Peak End Expiratory Pressure (PEEP) during exhalation.

During the time window, if patient effort is detected, either a Spontaneous or an Assist breath is delivered for the first effort. If the last breath delivered was Mandatory, then a Spontaneous breath is delivered for the first patient effort of the window. If the last breath delivered was an Assist or Spontaneous breath, then an Assist breath is delivered for the first patient effort of the window. Assist breaths deliver the prescribed Tidal Volume during inhalation and the PEEP setting during exhalation. Spontaneous breaths are delivered above the PEEP setting (PEEP compensated).

During the time window, if patient effort continues to be detected (after the first patient triggered breath), Spontaneous breaths are delivered for the remainder of the window. Spontaneous breaths deliver the prescribed Pressure Support setting above PEEP during inhalation and PEEP during exhalation. The figure below provides example breath patterns in SIMV mode.

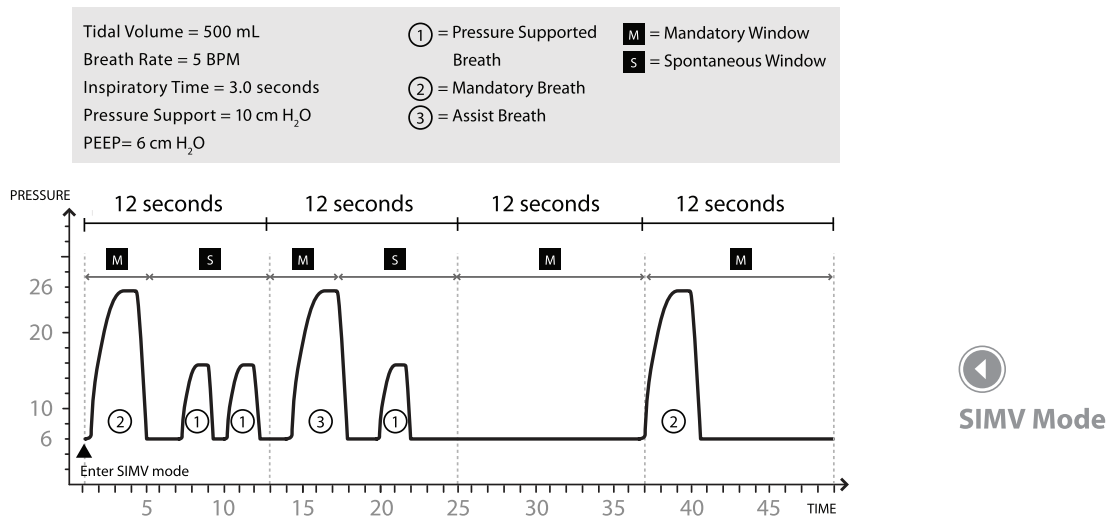

## Therapy Mode Features

The device has several additional features that enhance patient comfort.

### Flex Comfort Feature

The device consists of a special comfort feature called Flex. The device provides the Flex feature in CPAP mode and S mode. This feature is only available when Auto-Trak is enabled.

**Note:** Flex is not available if AVAPS is enabled or if an active circuit is used.

**Note:** The patient has access to this setting, if Flex is enabled.

### C-Flex

When in CPAP mode, if C-Flex is enabled, it enhances patient comfort by providing pressure relief during the expiratory phase of breathing. In the following diagram, the dashed lines represent normal CPAP therapy in comparison to the bold line representing C-Flex. C-Flex levels of 1, 2, or 3 progressively reflect increased pressure relief.

**Note:** C-Flex is not available if CPAP is set to 4 cm H<sub>2</sub>O.

**Note:** C-Flex, Bi-Flex, and AVAPS are intended for use by adult patients.

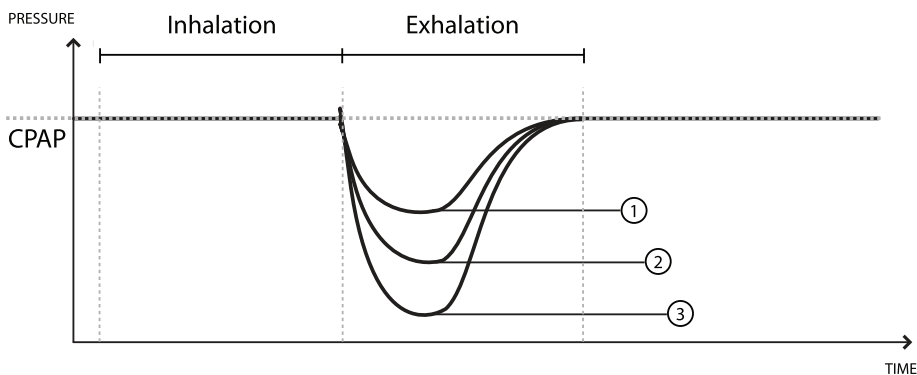

### C-Flex in Comparison to Traditional CPAP Therapy

C-Flex pressure relief is determined by the C-Flex setting and the amount of patient flow. C-Flex returns to the set pressure by the end of exhalation, when the airway is most vulnerable to closure.

### Bi-Flex

In S mode, the Bi-Flex attribute adjusts therapy by inserting a small amount of pressure relief during the latter stages of inspiration and during the beginning part of exhalation. In the following diagram, the bold lines represent Bi-Flex in comparison to the dashed line representing normal BiPAP therapy. Bi-Flex levels of 1, 2, or 3 progressively reflect increased pressure relief that will take place at the end of inspiration and at the beginning of expiration.

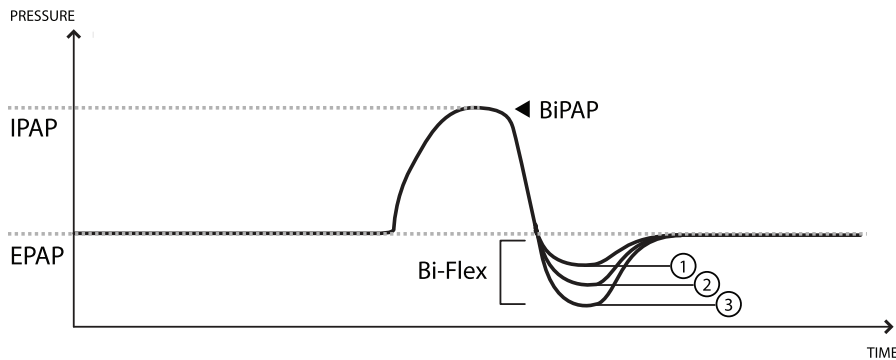

**Note:** Bi-Flex is only available up to 25 cm H<sub>2</sub>O in S mode.

◀ **Bi-Flex in Comparison to Traditional Bi-Level Therapy**

### Ramp

The device is equipped with a linear ramp function. In CPAP, S, S/T, T, and PC modes, the Ramp feature will reduce the pressure and then gradually increase (ramp) the pressure to the prescription pressure setting so patients can fall asleep more comfortably. The figure below illustrates how the ramp function works.

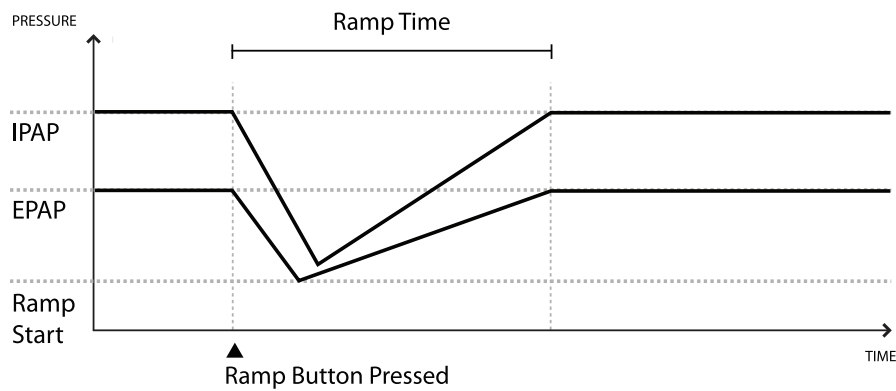

**Note:** IPAP will not ramp below 4 cm H<sub>2</sub>O.

◀ **The Ramp Function**

## Rise Time

In S, S/T, PC, T, PC-SIMV, and SIMV modes, rise time is the amount of time it takes the device to change from the expiratory pressure setting to the inspiratory pressure setting. Rise time levels of 1, 2, 3, 4, 5, or 6 progressively reflect slowed response of the pressure increase that will take place at the beginning of inspiration. Adjust the rise time to find the most comfortable setting for the patient.

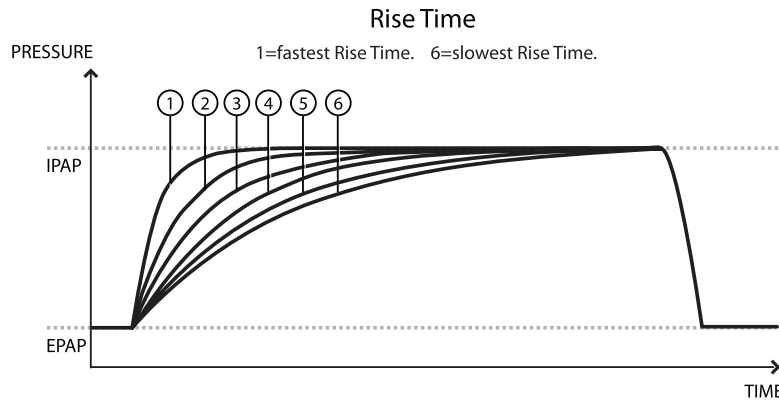

### Rise Time

## AVAPS Feature

Average Volume Assured Pressure Support (AVAPS) is a feature available in the S, S/T, PC, and T modes. It helps patients maintain a tidal volume ( $V_T$ ) equal to or greater than the target tidal volume (Volume setting in the ventilator) by automatically controlling the pressure support (PS) provided to the patient. The AVAPS feature adjusts PS by varying the IPAP level between the minimum (IPAP Min) and maximum (IPAP Max) settings. AVAPS averages  $V_T$  and changes the PS value gradually. This occurs over several minutes. The rate of change is slow, so that the patient is not aware of breath-to-breath pressure changes.

As patient effort decreases, AVAPS automatically increases PS to maintain the target tidal volume. The IPAP level will not rise above IPAP Max, even if the target tidal volume is not reached. Conversely, as patient effort increases, AVAPS will reduce PS. IPAP will not fall below IPAP Min, even if the target tidal volume is exceeded.

If the Ramp function has been activated, it will take precedence over the AVAPS feature. Once ramp is complete, AVAPS will resume.

**Note:** AVAPS is only available if you are using a passive circuit.

**Note:** C-Flex, Bi-Flex, and AVAPS are intended for use by adult patients.

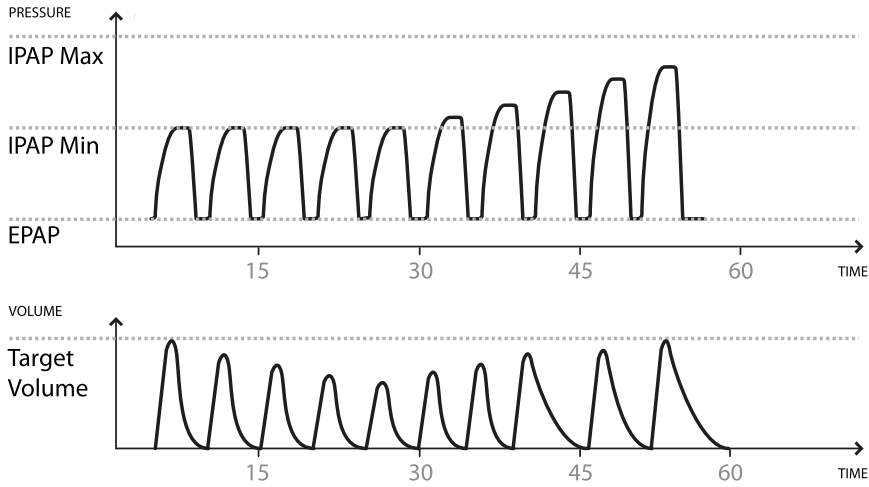

 AVAPS Feature

### Flow Pattern Types

Two flow patterns are available in Volume Control ventilation therapy modes:

- Square
- Ramp

#### Square

With a square wave pattern, airflow is generally constant throughout inspiration of the breath.

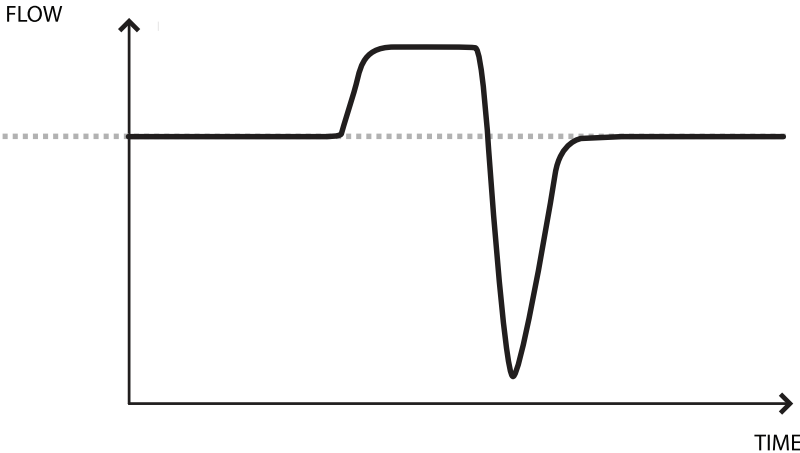

 Square Flow Pattern



## Ramp

With a ramp flow pattern, the airflow starts high and decreases throughout inspiration of the breath.

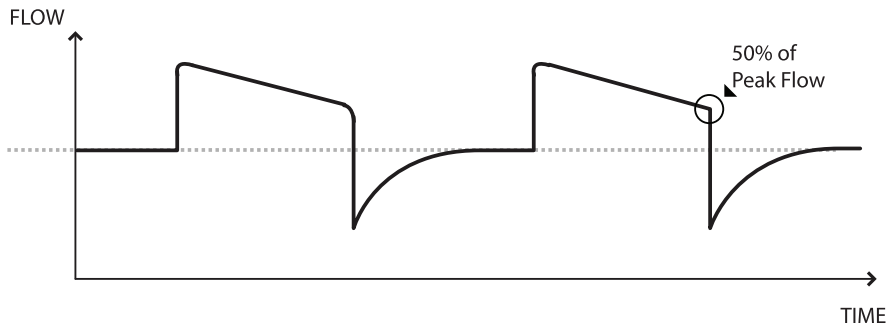

**Ramp Waveform Pattern**

For the active circuit in volume modes, peak flow is required to be a minimum of 20 l/min. The wave form may be flattened when the combination of Inspiratory Time and Tidal Volume set points would result in a flow of less than 20 l/min. Therefore, for some settings, a Ramp flow pattern may provide a pattern that more closely resembles a Square flow pattern.

## Sigh Feature

The sigh feature is available for Volume ventilation modes only. When the sigh feature is enabled, the ventilator delivers a sigh breath in place of every 100th mandatory or assisted breath delivered regardless of the mode of operation (i.e., AC, CV, and SIMV). The Sigh breath is delivered using a volume equal to 150% of the set volume that was in effect when the breath was initiated.

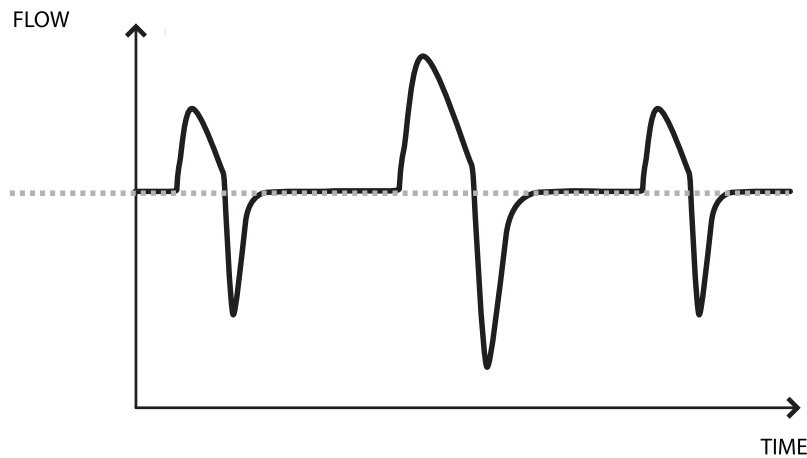

Example of Sigh Feature

## Dual Prescription Feature

The device provides a dual prescription feature that allows you to enter a primary prescription and a secondary prescription for the patient if needed. For example, you can set a primary daytime prescription a secondary nighttime prescription. See Chapter 5 for more information on the dual prescription feature.

**Note:** Both prescriptions must use the same circuit type.

## Triggering

The device can be set to trigger breaths using the Auto-Trak or Flow Trigger sensitivity features.

### Digital Auto-Trak Sensitivity

An important characteristic of the device is its ability to recognize and compensate for unintentional leaks in the system and to automatically adjust its trigger and cycle algorithms to maintain optimum performance in the presence of leaks. This feature is known as Digital Auto-Trak Sensitivity.

**Note:** Auto-Trak is only available if you are using a passive circuit.

### Flow Trigger

Flow Trigger Sensitivity (Expiration to Inspiration):

The Flow Trigger initiates when the patient's inspiratory effort creates a flow equal to or greater than the flow sensitivity setting.

Flow Cycle Sensitivity (Inspiration to Expiration):

This cycling method is only active if the Flow Trigger has been selected for the Trigger Type. As flow begins to decrease during inspiration, if the patient flow is less than the flow cycle setpoint, the device will cycle to expiration.

### BTPS Compensation

All flows and volumes used in Trilogy are expressed in BTPS - Body Temperature atmospheric Pressure Saturated with H<sub>2</sub>O.

All pressures are expressed relative to atmospheric pressure.

## Ventilator Alarms

This section describes all of the ventilator alarms and informational messages in order of priority, from high priority alarms to low priority alarms and finally informational messages. Refer to Chapter 6 for more information on alarms.

### Loss of Power Alarm

This is a high priority alarm. It may occur when a complete power failure has occurred and power was lost while the device was providing therapy. This may happen if the internal battery was the only power source in use and was completely depleted.

### Ventilator Inoperative Alarm

This is a high priority alarm. It occurs when the ventilator detects an internal error or a condition that may affect therapy. The device will shut down if the cause of the failure indicates that the device cannot deliver therapy safely. If the device can deliver therapy at a limited level, the device will continue to deliver limited therapy.

### Ventilator Service Required Alarm

This is a high priority alarm. It occurs when the device cannot perform to specification, a backup safety feature is compromised, or the delivery of therapy is compromised. The device continues to operate (possibly in a reduced capacity mode). If the problem is not corrected, the device will generate a reminder message once per hour until the issue is corrected. Additionally, if therapy is stopped, a reminder message will immediately appear when therapy is turned on again.

### Check Circuit Alarm

This is a high priority alarm. It occurs when the device detects a problem with the patient circuit, such as pinched or detached tubing, water condensation in the proximal pressure lines, or problems with the active exhalation device.

## Low Circuit Leak Alarm

This is a high priority alarm that only occurs with the passive circuit. It occurs when the system detects a problem with the leak device in the passive circuit.

## High Expiratory Pressure Alarm

This is a high priority alarm. It occurs when the delivered pressure exceeds the target patient pressure during the expiratory phase by 5 cm H<sub>2</sub>O. This may be due to pinched tubing or the patient having a fast breath rate. The device continues to operate. The alarm will automatically terminate when the delivered pressure comes within 5 cm H<sub>2</sub>O of the target patient pressure during the expiratory phase.

## Low Expiratory Pressure Alarm

This is a high priority alarm. It occurs when the delivered pressure is 5 cm H<sub>2</sub>O or more below the target patient pressure during the expiratory phase. The device continues to operate. The alarm will automatically terminate when the delivered pressure comes within 5 cm H<sub>2</sub>O of the target patient pressure during the expiratory phase.

## High Internal Oxygen Alarm

This is a high priority alarm. It occurs when there is a leak in the internal air delivery system that allows oxygen to build up inside the device. The alarm is generated when the internal oxygen concentration reaches 5% above ambient levels.

## Circuit Disconnect Alarm

This is a high priority alarm. It occurs when the breathing circuit is disconnected or has a large leak. The device continues to operate. The alarm will automatically terminate when the circuit is reconnected or the leak is fixed.



*You should not rely on any single alarm to detect a circuit disconnect condition. The Low Tidal Volume, Low Minute Ventilation, Low Respiratory Rate, and Apnea alarms should be used in conjunction with the Circuit Disconnect alarm. The Apnea alarm is only intended for spontaneously breathing patients.*

## Apnea Alarm

This is a high priority alarm. It occurs when the patient has not triggered a breath within the time specified in the apnea alarm setting. The device continues to operate. The alarm will automatically terminate when two consecutive patient breaths are detected that meet the apnea alarm time setting.

**Note:** Apnea alarm is not available in T and CV modes.

## High Vte Alarm

This is a high priority alarm. It occurs when the estimated exhaled tidal volume is greater than the High Vte alarm setting for three consecutive breaths. The device continues to operate. The alarm will automatically terminate when a breath occurs in which the exhaled tidal volume does not reach the High Vte alarm setting.

## Low Vte Alarm

This is a high priority alarm. It occurs when the estimated exhaled tidal volume is lower than the Low Vte alarm setting for three consecutive breaths. The device continues to operate. The alarm will automatically terminate when a breath occurs in which the exhaled tidal volume exceeds the Low Vte alarm setting.

When AVAPS is on, this alarm will occur when the calculated tidal volume is less than 90% of the target tidal volume setting. The alarm will automatically terminate when a breath occurs in which the exhaled tidal volume is equal or greater to 90% of the target tidal volume setting.

## High Vti Alarm

This is a high priority alarm. It occurs when the delivered tidal volume is greater than the High Vti alarm setting for three consecutive breaths. The device continues to operate. The alarm will automatically terminate when a breath occurs in which the delivered tidal volume does not reach the High Vti alarm setting.

### **Low Vti Alarm**

This is a high priority alarm. It occurs when the delivered tidal volume is less than the Low Vti alarm setting for three consecutive breaths. The device continues to operate. The alarm will automatically terminate when a breath occurs in which the delivered tidal volume exceeds the Low Vti alarm setting.

### **High Respiratory Rate Alarm**

This is a high priority alarm. It occurs when the respiratory rate is greater than the High Respiratory Rate alarm setting. The device continues to operate. The alarm will automatically terminate when the measured respiratory rate is less than the High Respiratory Rate alarm setting.

### **Low Respiratory Rate Alarm**

This is a high priority alarm. It occurs when the respiratory rate is less than the Low Respiratory Rate alarm setting. The device continues to operate. The alarm will automatically terminate when the measured respiratory rate is greater than the Low Respiratory Rate alarm setting.

### **High Inspiratory Pressure Alarm**

This alarm occurs in several stages and escalates from an audible beep for the first two occurrences to a high priority alarm if the problem continues. It is detected differently for volume and pressure therapy modes.

For volume modes, the alarm will sound if the measured patient pressure exceeds the High Inspiratory Pressure setting specified by the clinician. The alarm will automatically terminate when the peak inspiratory pressure is less than or equal to the High Inspiratory Pressure alarm setting.

For pressure modes, the alarm occurs when the delivered pressure exceeds the target patient pressure by 5 cm H<sub>2</sub>O or more during the inspiratory phase. The device will automatically cycle to the expiratory phase and continue to operate. The alarm will automatically terminate when the delivered pressure falls within 5 cm H<sub>2</sub>O of the target patient pressure during the inspiratory phase.

### **Low Inspiratory Pressure Alarm**

This is a high priority alarm. It is detected differently for volume and pressure therapy modes.

For volume modes, the alarm will sound if the measured patient pressure is less than the Low Inspiratory Pressure setting specified by the clinician. The alarm will automatically terminate when the peak pressure at the end of the breath is greater than or equal to the Low Inspiratory Pressure alarm setting.

For pressure modes, the alarm occurs when the delivered pressure is 5 cm H<sub>2</sub>O or more below the target patient pressure during the inspiratory phase. The alarm will automatically terminate when the delivered pressure comes within 5 cm H<sub>2</sub>O of the target patient pressure during the inspiratory phase.

### **High Minute Ventilation Alarm**

This alarm is a high priority alarm. It occurs when the patient's minute ventilation is greater than the High Minute Ventilation alarm setting. The device continues to operate. The alarm will automatically terminate when the calculated minute ventilation is less than the High Minute Ventilation alarm setting.

### **Low Minute Ventilation Alarm**

This alarm is a high priority alarm. It when the patient's minute ventilation is less than the Low Minute Ventilation alarm setting. The device continues to operate. The alarm will automatically terminate when the calculated minute ventilation is greater than the Low Minute Ventilation alarm setting.



## Low Battery Alarm

The Low Battery alarm occurs when the last battery available is low or nearly depleted. This alarm occurs in two stages. When approximately 20 minutes of battery run time remains, a medium priority alarm is generated, and the device continues to operate. If no action is taken and the battery continues to deplete, the alarm escalates to a high priority alarm when approximately 10 minutes of battery run time remains.

## High Temperature Alarm

This alarm occurs when the estimated patient airstream temperature or the ventilator internal temperature is too high. The alarm occurs in several stages. The ventilator continues to operate. Internal fans are started when the medium priority alarm is generated. If the condition causing the high temperature is not corrected and the temperature continues to rise, the alarm will escalate to the high priority alarm.

## Replace Detachable Battery Alarm

The Replace Detachable Battery alarm occurs when the detachable battery is nearing the end of its useful life or a failure in the detachable battery that prevents it from charging or discharging has been detected.

The alarm occurs in several stages, from low to high priority. The device continues to operate when the alarm is the low priority alarm. If the alarm is reset without removing the battery, the alarm will be regenerated once every hour until the detachable battery is removed. The device continues to operate, the detachable battery is not used, and the power source is switched to the next available power source if the alarm is the high priority alarm.

### WARNING

*Immediately seek an alternate power source when the “Low Battery” message appears. Complete power failure and loss of therapy is imminent.*

### WARNING

*The ventilator has a two-stage low battery alarm. The medium priority alarm indicates that approximately 20 minutes of operation remain, and the high priority alarm indicates that less than 10 minutes of operation remain. Actual run time may be more or less than this and varies with battery age, environmental conditions, and therapy.*

## AC Power Disconnected Alarm

This is a medium priority alarm. It occurs when the AC power source was lost, and the device has switched to an alternate power source (either a detachable or external battery, if connected, or the internal battery if no other source is available). The device continues to operate. If AC power returns, the ventilator will beep, but no message will appear on the display.

## Keypad Stuck Alarm

This is a low priority alarm. It occurs when a key becomes lodged inside the case of the device.

## Battery Discharging Stopped due to Temperature

### Info Message

This info message occurs when the detachable or internal battery becomes overheated while providing power for the device. The device continues to operate. The battery is not used and the power source is switched to the next available power source.

## Battery Not Charging due to Temperature Info Message

This info message occurs when the detachable or internal battery becomes too hot while charging or the device was in too cold an environment before charging started. The device continues to operate. Battery charging stops until the battery cools or warms sufficiently.

## Battery Not Charging Info Message

This info message occurs when the device has detected an error condition with the battery that prevents it from accepting a charge. The device continues to operate. Battery charging stops.

### **Check External Battery Info Message**

This info message occurs when a bad connection exists to the external battery or the external battery failed. The device continues to operate using power from the detachable battery, if available, or the internal battery.

### **Battery Depleted Info Message**

This info message occurs when the affected battery is fully depleted. The device continues to operate using the next available power source.

### **External Battery Disconnected Info Message**

This info message occurs when the external battery power source is lost and the device has switched to an alternate power source (either a detachable battery, if connected, or the internal battery if no other source is available). If external battery power returns, the ventilator will beep, but no message will appear on the display.

### **Detachable Battery Disconnected Info Message**

This info message occurs when the detachable battery power source is lost and the device has switched to an alternate power source (the internal battery if no other source is available). If detachable battery power returns, the ventilator will beep, but no message will appear on the display.

### **Start On Battery Info Message**

This info message indicates that the ventilator has started on battery power and no AC power is available. The device operator should verify that this is what is wanted.

### **Card Error Info Message**

This info message occurs when an unusable SD card is inserted into the ventilator. The device continues to operate but data cannot be logged onto the SD card.

## 4. Ventilator Setup

This chapter provides instructions on how to assemble the ventilator. It includes the following setup information:

- Properly positioning the device
- Installing the air filter
- Supplying power to the device
- Connecting the breathing circuit

 **WARNING**

*Ventilator dependant patients should be continuously monitored by qualified personnel. These personnel should be prepared to provide alternate therapy in the event of ventilator failure or inoperative equipment.*

 **WARNING**

*Do not use the ventilator on a patient until a system checkout has been performed. See Chapter 10 of this manual.*

 **WARNING**

*For ventilator dependent patients, always have alternate ventilation equipment, such as a back-up ventilator, manual resuscitator, or similar device, available.*

 **CAUTION**

*Do not operate the ventilator at temperatures below 5° C (41° F) or above 40° C (104° F).*

## Position the Device

Place the ventilator on a flat, level surface. Or, as an alternative, you can place the device in the optional in-use bag. The in-use bag is required for portable use in order to properly secure the ventilator.

Do not operate the ventilator while on its side, upside-down, or in any other orientation. Make sure that the air inlet on the back of the device is not blocked. If you block the air flow around the device, the ventilator may not work properly. Do not operate the ventilator in the carrying case provided with the device.

## Install the Air Filter

The device uses a gray foam filter that is washable and reusable. The reusable filter screens out normal household dust and pollens. The filter must be in place at all times when the device is operating. Two reusable gray foam filters are supplied with the device. If the filter is not already installed when you receive the device, you must install the filter before using the ventilator.

To install the filter, insert the gray foam filter into the filter area as shown.

## First Time Use

When setting up the device for the first time or after annual service, apply AC power to the ventilator before turning on the blower. Attempting to use the ventilator without first applying AC power, such as installing a detachable battery pack and starting the blower, will cause the internal battery to be displayed in red as an empty battery. When in this state, the internal battery will not be usable until AC power is applied.

### CAUTION

*The reusable foam inlet filter is required to protect the ventilator from dirt and dust. Wash periodically and replace when damaged for proper operation.*

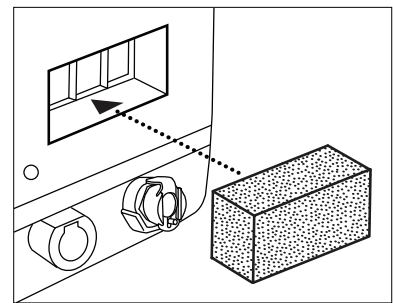

### Installing the Filter

**Note:** See Chapter 7 for information on how to clean and replace the air filter.

## Supply Power to the Device

The device can operate on AC or DC power. The ventilator accesses power from potential sources in the following order:

- AC Power
- External Battery
- Detachable Battery Pack
- Internal Battery

### Using AC Power

An AC power cord is provided with the device.

1. Plug the socket end of the AC power cord into the AC power inlet on the side of the device. To prevent accidental removal of the AC power cord from the device, you may secure the AC power cord to the device using the AC power cord retainer located on the back of the device.
2. Plug the pronged end of the cord into a wall outlet not connected to a wall switch.
3. Ensure that all connections are secure. If AC power is connected correctly and the device is operating properly, the green AC Power LED should be on.

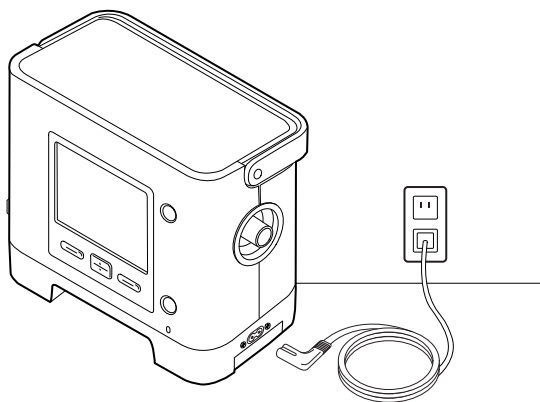

**Note:** This device is activated (i.e., 'powered on') when the AC power cord is connected or any of the three battery sources is available. Pressing the Start/Stop button turns the airflow on or off.

#### CAUTION

The device may only be operated at temperatures between 5° C and 40° C (41° F and 104° F).

#### WARNING

Periodically inspect the power cord for damage or signs of wear. Discontinue use and replace if damaged.

**Note:** To remove AC power, disconnect the power supply cord from the electrical outlet.



#### Connecting the AC Power Cord

- If desired, secure the power cord using the cord retainer on the back of the device, as shown below. To secure the power cord, use a screwdriver to remove the screw on the cord retainer. Insert the cord as shown into the cord retainer, and then re-attach the cord retainer to the device by re-attaching the screw.

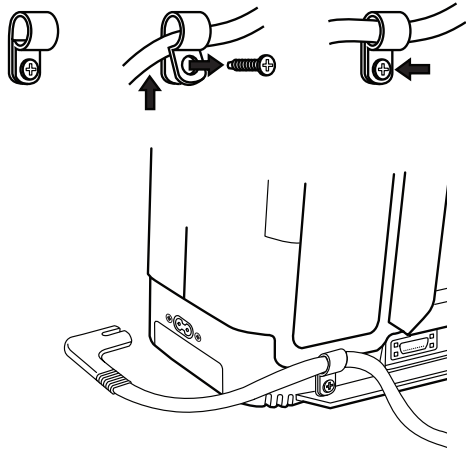

#### Securing the Power Cord Using the Cord Retainer

## Using DC Power

You can operate the ventilator using an external battery, detachable battery, or the internal battery.

### External Battery

The ventilator can operate from a 12 VDC deep cycle marine-type (lead acid) battery using the Philips Respironics Trilogy External Battery Cable. This cable is pre-wired and properly terminated to ensure safe connection of an external battery to the ventilator. Battery operating time depends on the characteristics of the battery and usage of the device.

Due to a variety of factors, including battery chemistry, battery age, and use profile, the capacity of the external battery as shown on the device display is only an estimate of the actual remaining capacity.

Refer to the instructions supplied with the Philips Respironics Trilogy External Battery Cable for detailed information on how to operate the device using an external battery.

#### CAUTION

*Do not use the same external battery to operate both the ventilator and any other equipment such as power chairs.*

#### CAUTION

*An external battery should only be connected to the ventilator using the Philips Respironics Trilogy External Battery Cable. This cable is fused, pre-wired and properly terminated to ensure safe connection to a standard deep cycle lead acid battery. Use of any other adapter or cable may cause improper operation of the ventilator.*

## Detachable Battery Pack

Philips Respironics offers a detachable Lithium-Ion battery pack. To use the detachable battery pack, snap the battery into place on the back of the ventilator, as shown in the following illustration. When the device is not connected to an AC power source or an external battery, the detachable battery will power the device, if attached. The length of time the ventilator will operate on battery power depends on many factors such as device settings, battery charge level, and condition or age of the battery. When fully charged, a new battery can power the ventilator for approximately three hours under typical patient conditions.

Whenever the ventilator is connected to AC power, it will automatically recharge the detachable battery pack. A completely discharged detachable battery will reach 80% charge status within 8 hours, when charging at approximately 23° C (73° F) ambient temperature.

Insert and securely latch the detachable battery into the device as shown below.

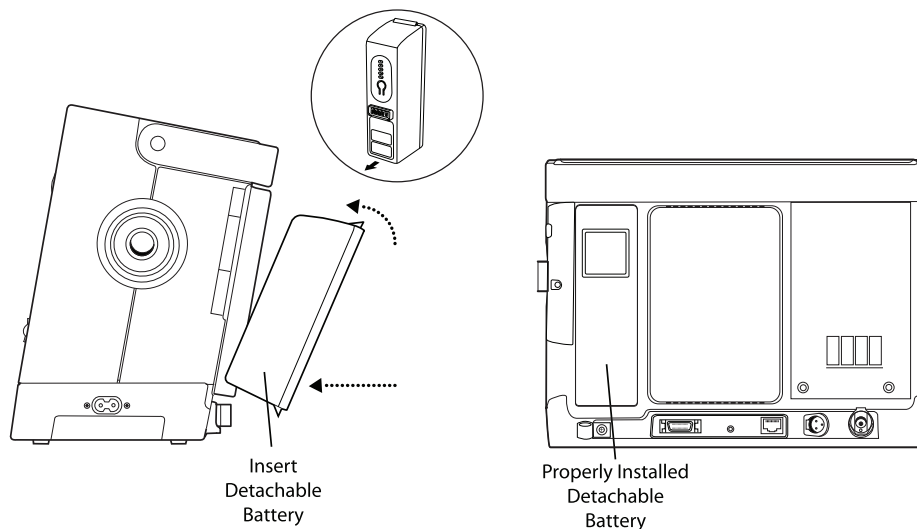

### CAUTION

*The detachable and internal batteries wear out based on the amount of use (hours or full charge-discharge cycles). The battery capacity and life are also reduced by operation at higher temperatures.*

### CAUTION

*Only use the Philips Respironics Trilogy Detachable Battery with the device.*



### Attaching the Detachable Battery

### CAUTION

*Prolonged operation or storage at elevated temperatures may reduce the service life of the detachable or internal battery and other internal components of the ventilator.*



One side of the detachable battery has a set of LEDs that indicate the amount of charge left on the battery. You can press the button below the LEDs to view how much charge remains:

LED	Battery Capacity
All 5 LEDs are lit	80-100% capacity
4 LEDs are lit	60-79% capacity
3 LEDs are lit	40-59% capacity
2 LEDs are lit	20-39% capacity
1 LED is lit	10-19% capacity
1 LED flashes	1 to 9% capacity
0 LEDs are lit	0% capacity

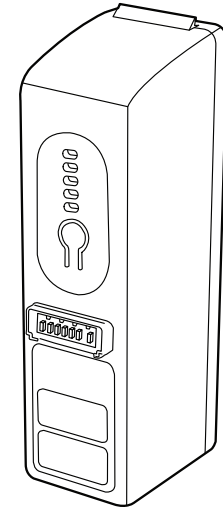

 Detachable Battery LEDs

### Internal Battery

The device contains an internal battery that can be used as a back-up power source. It is intended for use during short periods while switching between external power sources, emergency situations, or short durations when the user needs to be mobile. The length of time the ventilator will operate on internal power depends on many factors such as device settings, battery charge level, and condition or age of the battery. When fully charged, a new battery can power the ventilator for approximately three hours under typical patient conditions.

Whenever the ventilator is connected to AC power, it will automatically recharge the internal battery. A completely discharged internal battery will reach 80% charge status within 8 hours when charging at approximately 23° C ( 73° F) ambient temperature.

### Device Power Source Indicators

There are many power source indicators on the device and the display screen. These indicators are described in detail below.

#### AC Power Indicator



When AC power is applied to the device, the green AC LED indicator (~) on the front of the device lights.

#### WARNING

*The internal battery is NOT intended to serve as a primary power source. It should only be used when other sources are not available, or briefly when necessary; for example when changing power sources.*



## DC Power Indicators



The internal, detachable, and external battery symbols that will display on the Monitoring screen are shown below. The detachable and external battery symbols will only appear on-screen if a detachable or external battery is attached to the device.

Battery	Symbol
Internal Battery	
Detachable Battery	
External Battery	

**Note:** Under normal operating conditions, the internal battery symbol will always display on the Monitoring screen. If the symbol appears as an empty red battery on your screen, contact Philips Respironics or an authorized service representative to have your device serviced.

There are several DC power indicators that will display on the Monitoring screen to indicate which battery is in use (if applicable), if the batteries are low, charging, or discharged, etc. The following table explains all of the DC power indicators.

DC Power Indicator	Description
Battery In Use Indicator 	A black box will appear around the battery that is in use. For instance, if the external battery is currently in use, the  symbol appears on the Monitoring screen.
Green Fully Charged Battery Indicator	When a battery is charged to greater than 90% of its capacity, all of the bars in the battery symbol will appear in green.
Partially Charged Battery Indicator	When a battery is partially charged, some of the bars in the battery symbol will appear in green, while others will be clear. For instance, if the external battery is 50% charged, the following symbol displays on-screen: 
Yellow Low Battery Indicator (Medium Priority)	When the device detects that an in-use battery's charge is low (has approximately 20 minutes of charge left), the inside of the box surrounding the battery symbol turns yellow. (In addition to the battery indicator on the Monitoring screen, a medium priority alarm message will display indicating "Low Battery." See Chapter 6 for more information. The yellow indicator is for the last available battery source.

DC Power Indicator	Description
Red Low Battery Indicator	When the device detects that an in-use battery's charge is nearly depleted (has approximately 10 minutes of charge left), the inside of the box surrounding the battery symbol turns red. In addition to the battery indicator on the Monitoring screen, a high priority alarm message will display indicating "Low Battery." See Chapter 6 for more information. The red indicator is for the last available battery source.
Yellow Battery Recharging Symbol 	Whenever AC power is applied to the device, the internal and detachable batteries will recharge as needed. If the internal battery is being recharged, the  symbol displays. If the detachable battery is being recharged, the  symbol displays.

## Battery Disposal

Dispose of the batteries in accordance with local regulations.

## Connect the Breathing Circuit to the Ventilator

Complete the following steps to set up your patient circuit.

1. If you are using a bacteria filter, connect one end of the flexible tubing to the outlet of the bacteria filter, and connect the bacteria filter inlet to the breathing circuit connection located on the side of the ventilator. If you are not using a bacteria filter, connect the tubing directly to the device's breathing circuit connection.

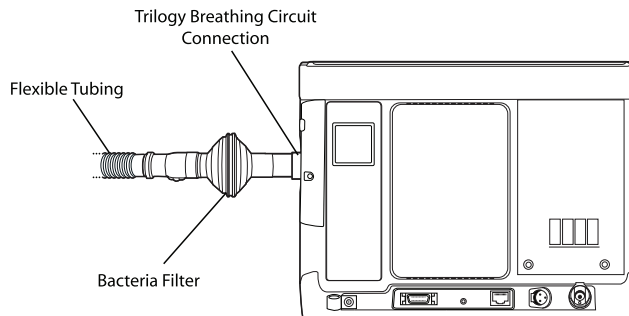

2. Connect the other end of the flexible tubing to a separate exhalation device.
  - a. If your circuit type is Passive and you are using a Philips Respironics Passive Exhalation Device:
    1. Connect the flexible tubing to the rotating end of the Passive Exhalation Device.
    2. Connect the other end of the Passive Exhalation Device to the patient interface (e.g., the mask).

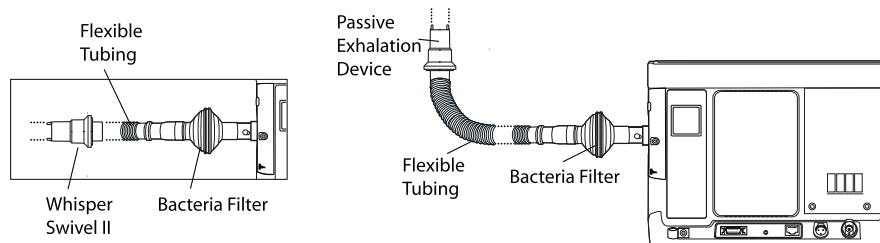

Refer to the instructions included with the Passive Exhalation Device for more detailed setup information.

### WARNING

*Philips Respironics recommends that a main line outlet bacteria filter (Part Number 342077) be used whenever the device is used for invasive therapy or if the ventilator may be used on multiple patients.*



### Connecting the Breathing Circuit to the Device

**Note:** *The device can be used with reusable or disposable circuits. For detailed instructions on how to set up your device using a disposable circuit, refer to the instructions included with the disposable circuit.*



### Connecting the Passive Exhalation Device

**Note:** *The device does not provide circuit compliance compensation in volume modes.*

- b. If your circuit type is Active PAP:

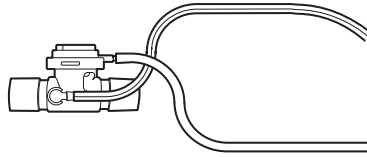

1. Connect the flexible tubing to an Active Exhalation Device with proximal pressure.
  - A. Connect the active exhalation device with proximal pressure to the flexible tubing that attaches to the ventilator and to the patient interface (e.g., the tracheostomy tube).
2. Connect the proximal pressure line and the exhalation valve line to the Active Exhalation Device with proximal pressure and the Active Exhalation Porting Block on the device as shown below.
  - A. Attach the proximal pressure line to the proximal pressure port as shown in the next illustration.
  - B. Connect the other end of the proximal pressure line to the top port on the Exhalation Porting Block.
  - C. Connect the exhalation valve line to the exhalation valve port on the top of the Active Exhalation Device with PAP.
  - D. Connect the other end of the exhalation valve line to the exhalation valve port on the Exhalation Porting Block.



### Active Exhalation Device with Proximal Pressure

**Note:** Passive circuit ventilation provides leak compensation in both volume and pressure modes. Active circuit ventilation does not provide leak compensation. Particular care should be used at low tidal volumes to ensure adequate monitoring of exhaled tidal volume.



### WARNING

For ventilator dependent patients, always have alternate ventilation equipment, such as a back-up ventilator, manual resuscitator, or similar device, available.

**Note:** Make sure that components marked with an arrow are oriented properly. When attaching the active circuit with PAP to the patient, make sure the proximal pressure port faces away from the patient.

**Note:** The  symbol appears next to the Exhalation Valve port on the Porting Block to indicate where the active exhalation valve line connects.

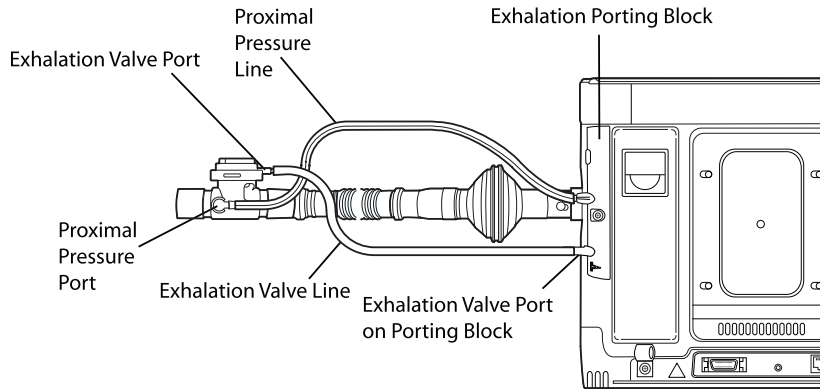

### Connecting an Active Exhalation Device with Proximal Pressure

Refer to the instructions included with the Active Exhalation Device for more information.

## Changing the Exhalation Porting Blocks

The Passive Exhalation Porting Block is pre-installed on the device. If you need to change the exhalation porting blocks, follow the steps below.

1. Using a screwdriver, remove the screw located in the center of the exhalation porting block, as shown below.

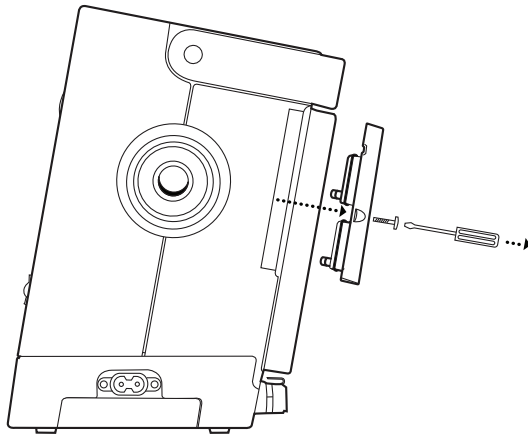

### Unscrewing the Exhalation Porting Block

- Using the flat side of the screwdriver, pry the exhalation porting block away from the device until it comes loose, as shown below.

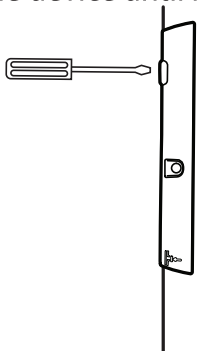

### Removing the Exhalation Porting Block

- Align the exhalation porting block that you want to use with the porting block area on the device, and using a screwdriver and screw, insert the exhalation porting block into the device as shown below. Make sure it is screwed all the way in and is securely in place.

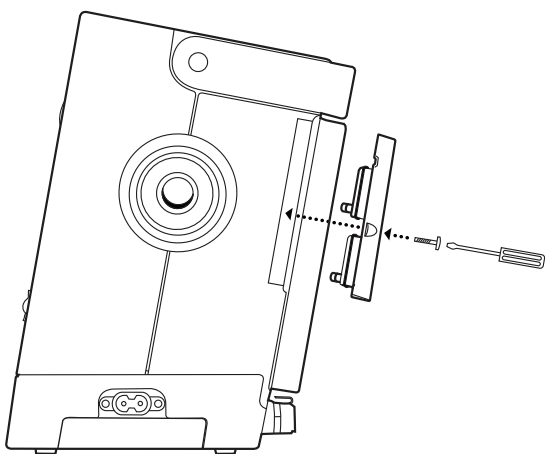

### Installing a New Exhalation Porting Block

## Connect Supplemental Oxygen (Optional)

To attach supplemental oxygen to the device:

1. Connect the oxygen tubing to the Oxygen Inlet Quick Connect. Then, connect the Quick Connect to the Oxygen Inlet on the back of the ventilator.

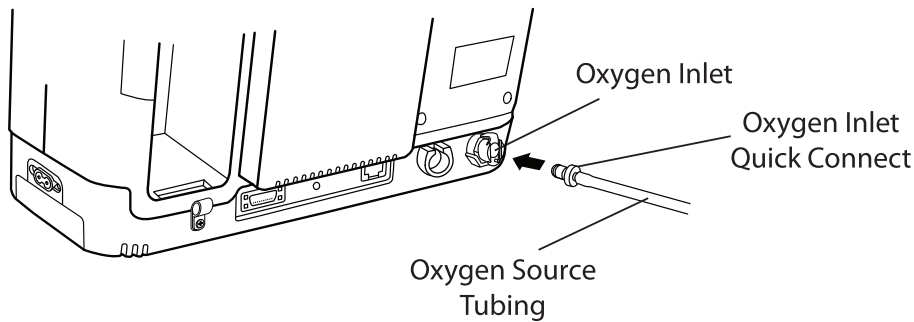

**Attaching the O<sub>2</sub> Tubing**

2. Make sure you press the Oxygen Inlet Quick Connect firmly into the inlet. You should hear a click, and the latch at the top of the inlet will pop up.

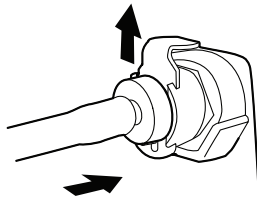

This device is only compatible with a low flow oxygen source providing up to 15 l/min.



**Press Tubing in and Latch Pops Up**



**CAUTION**

*Do not connect an unregulated or high pressure oxygen source to this connector on the device.*





## 5. Viewing and Changing Settings

This chapter explains how to scroll through the ventilation screens and change ventilation settings. It also describes how to connect the ventilator to the patient once the settings are complete.

### Keypad Lock Feature

There is a Keypad Lock feature that users can enable from the Options menu. It is intended to prevent accidental changes to device settings. This feature will lock the navigation keys (Up, Down, Stop, Left, and Right keys). If the Keypad Lock is enabled, a Keypad Unlock message will display on the bottom of the screen any time you press one of the navigation keys.

If the keypad is locked, you must unlock it before you can enter the Menu. To unlock the keypad and enter the menu, you must first hold the Right button for 5 seconds to unlock the keypad. An audible indicator sounds when the keypad is successfully unlocked. Once the display is unlocked, you can enter the Menu as you normally would by pressing the Up button.

**Note:** There is a keypad lock inactivity time-out period. After you have unlocked the keypad as indicated, the keypad will re-lock after five minutes of inactivity to prevent someone from accidentally pressing a button and changing any of the settings.

**Note:** When Keypad Lock is enabled, the Left, Right, and Up/Down buttons are locked while the ventilator is turned on. The Alarm Indicator/Audio Pause and Start/Stop buttons continue to function normally. The Start/Stop button is locked only when this button is used to stop therapy.

**Note:** The keypad will automatically unlock if an alarm or informational message occurs and will remain unlocked the entire time alarms are active.

**Note:** Pressing the Left (Cancel) button will cancel the Keypad Unlock action.

## Accessing the Startup and Monitor Screens

1. After you press the  button to begin therapy, the Startup screen appears momentarily, indicating the device name and the software version.
2. The next screen that appears is the Monitor screen. The appearance of this screen will vary, depending on how you set up the device. If Detailed View is turned off in the Options menu, your screen will look like the screen shown below.

**Note:** The symbols that appear on the Monitor screen are described in detail later in this chapter.

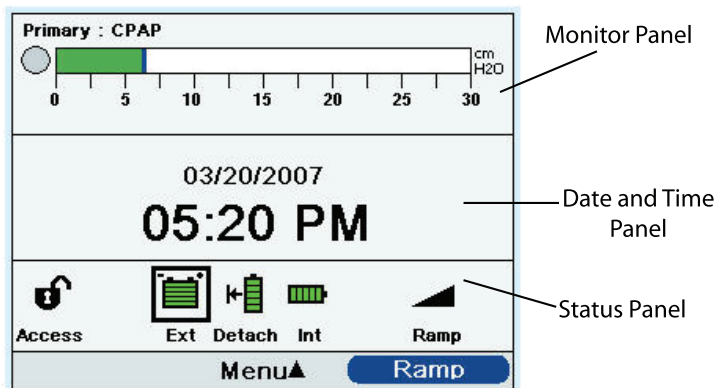

### Monitor Screen – Detailed View Off

- The top section of the screen, called the Monitor panel, shows the therapy mode and, if you set up a dual prescription for the patient, the Prescription indicator appears, indicating Primary or Secondary prescription. The patient breath symbol also displays during a patient-triggered breath, and a bar graph displays the current pressure level.
- The center section of the screen displays the current date and time.
- The bottom section, called the Status panel, displays certain symbols that indicate features being used, such as Ramp, as well as battery status.

**Note:** No Soft Buttons display on the Monitor screen if Keypad Lock is enabled.

If Detailed View is turned on in the Options menu, the Monitor screen will look like the screen shown below.

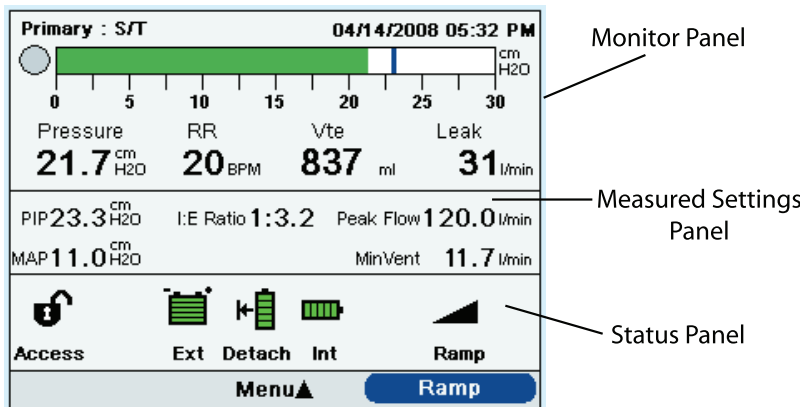

Monitor Screen – Detailed View On

This screen contains more detailed information about the therapy.

- The top Monitor panel contains the Prescription indicator if a dual prescription exists, the therapy mode, a graph displaying the current pressure, and the current date and time. Additionally, this panel also displays patient pressure, respiratory rate (RR), exhaled tidal volume (Vte), and leak.
- The second panel in Detailed view is the Measured Settings panel. It provides patient-related data including Peak Inspiratory Pressure (PIP), Minute Ventilation, Peak Inspiratory Flow, Mean Airway Pressure (MAP), and I:E Ratio.
- The third panel is the Status panel and shows the same information displayed in the Detailed View Off screen, including features in use such as Ramp and battery status.

## Monitor Screen Indicators

This section describes the following indicators:



- Monitor Panel Indicators
- Measured Settings Panel Indicators
- Status Panel Indicators

### Monitor Panel Indicators

All of the indicators that may appear on the Monitor Panel are described in detail in the following table.

**Note:** Dashes on the display screen indicate that the device was unable to compute the parameters. For example, when the device is first connected to a patient, the tidal volume, minute ventilation, and leak may be dashed until the device is able to accurately calculate these patient parameters.

Indicator	Description
Prescription	If you set up a dual prescription for the patient, the words "Primary" or "Secondary" appear in the top left corner of the panel to indicate which prescription is active.
Therapy Mode	The current therapy mode displays at the top of the panel (for example, CPAP, S, S/T, etc.). If a special feature such as Flex, AVAPS, or Sigh is active, this feature will appear next to the therapy mode.
Date and Time	If you are in Detailed view, the current date and time appear in the top right corner of the panel. (In Detailed View Off, they appear in the center panel.)
Patient Breath 	This symbol displays during a patient-triggered breath.
Airway Pressure Manometer and Peak Pressure Symbol	The manometer (bar graph) displays the airway pressure in the patient circuit at all times. The manometer bar moves to the right as pressure increases during inhalation, and moves to the left as pressure decreases during exhalation. The peak pressure is also indicated on this bar. It is positioned according to the maximum patient pressure reached during each breath. The Peak Pressure symbol appears as a blue bar on the manometer. If a High Inspiratory Pressure alarm occurs, the Peak Pressure symbol changes from blue to red.

Indicator	Description
Low Pressure Indicator 	If you enable a volume therapy mode, this indicator appears below the manometer bar, indicating the low pressure alarm setting.
High Pressure Indicator 	If you enable a volume therapy mode, this indicator appears below the manometer bar, indicating the high pressure alarm setting.
Pressure	This indicator displays the current patient pressure. This only appears in detailed view.
Respiratory Rate (RR)	This indicator displays the measured respiratory rate in Breaths Per Minute (BPM). This only appears in detailed view.
Exhaled Tidal Volume (Vte)	This indicator displays the estimated exhaled tidal volume in milliliters and reflects compensation for BTPS. This only appears in detailed view when Passive Circuit is selected.
Inhaled Tidal Volume (Vti)	This indicator displays delivered tidal volume in milliliters and reflects compensation for BTPS. This only appears in detailed view when the Active with PAP Circuit is selected.
Leak	This indicator displays the total leak (non-returned flow), between the unit outlet and the patient, averaged over the previous breath. This only appears in detailed view when the Passive Circuit is selected.







## Measured Settings Panel

All of the indicators that may appear on the Measured Settings panel (available only in Detailed view), are described in the following table.







Indicator	Description
PIP	Peak Inspiratory Pressure displays the maximum pressure delivered to the patient during the previous breath.
I:E Ratio	Displays a comparison of the time spent in inspiration to the time spent in expiration during the previous breath.
Peak Flow	Displays the maximum inspiratory flow delivered to the patient during the previous breath in l/min BTPS.
MAP	Displays the Mean Airway Pressure, which is the weighted average of pressure in the patient's airway over 6 breaths.
MinVent	Minute ventilation displays the amount of air delivered to the patient over the last minute in l/min BTPS.

## Status Panel Indicators

All of the indicators that may appear on the Status Panel are described in the following table.

Indicator	Description
	<p>Indicates that the device is in Full Menu Access mode, which means you can adjust all prescription settings. Philips Respironics recommends that you change the device to Limited Menu Access mode before giving the device to the patient, so patients cannot adjust their prescription settings. <b>Only trained health care professionals and clinicians should adjust prescription settings.</b></p>
	<p>Displays when a Secure Digital (SD) memory card is inserted in the ventilator.</p>
	<p>Displays when the ventilator detects an error with the SD card.</p>
	<p>Displays at all times when an external battery is attached to the ventilator. The level of green shading shown in the symbol indicates the battery capacity and will go down as the battery charge level decreases. When the entire symbol is green, the battery is fully charged.</p>
	<p>Displays at all times when a detachable battery is attached to the ventilator. The level of green shading shown in the symbol indicates the battery capacity and will go down as the battery charge level decreases. When the entire symbol is green, the battery is fully charged.</p>
	<p>Displays at all times, indicating the status of the internal battery. The level of green shading shown in the symbol indicates the battery capacity and will go down as the battery charge level decreases. When the entire symbol is green, the battery is fully charged.</p>



Indicator	Description
	<p>A black box displays around the battery that is currently supplying power to the ventilator when AC power is not available. (In the status panel shown above, the external battery is in use, so the  symbol displays.)</p>
	<p>A yellow lightning bolt symbol displays with the Detachable or Internal battery symbol to indicate when the battery is charging. (In the status panel shown on the previous page, the detachable battery is being charged, so the  symbol displays.)</p>
	<p>Displays when the Alarm Indicator/Audio Pause button has been pressed and Audio Pause is active. The alarm is silenced for one minute when the Alarm Indicator/Audio Pause button is pressed.</p>
	<p>Displays when the Ramp feature is active.</p>

**Note:** If a battery in use is very low (less than 20 minutes remaining), the inside of the box surrounding the battery symbol will change to yellow and all of the bar indicators in the battery will be empty. If a battery in use is near depletion (less than 10 minutes remaining), the inside of the box surrounding the battery symbol will change to red, and all of the bar indicators in the battery will be empty. These color changes only occur for the last available battery source.

## On-Screen Button Panel

The illustration below shows the on-screen button panel on the Main Menu screen, in relation to the buttons on the front of the device.

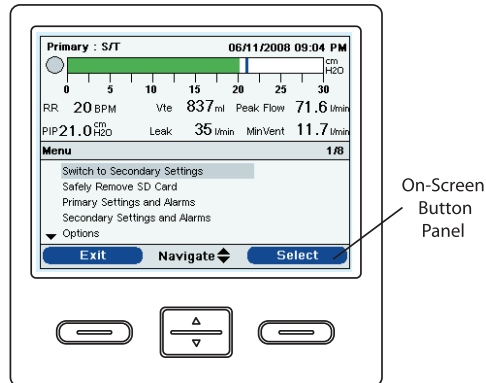

### Example On-Screen Button Panel

**Note:** The on-screen buttons will vary depending on which screen is displayed and what settings are enabled on your device.

At the very bottom of the display screen is the on-screen button panel. This panel corresponds with the control buttons on the ventilator:

- The left on-screen button specifies the action for the Left button on the device.
- The center on-screen button specifies the action for the Up/Down buttons on the device.
- The right on-screen button specifies the action for the right button on the device.

## Navigating the Menu Screens

To navigate through all of the menu screens and settings:

- Use the Up/Down button to scroll through the menu options and settings.
- Use the Left and Right buttons to perform the actions specified on the screens' left and right on-screen buttons.

## Changing and Viewing Settings in Full Menu Access Mode

Clinicians can view and change settings using the Menu screens when the device is in Full Menu Access mode. To enter the Menu screens from the Monitor screen, press the Up button on the ventilator. The Main Menu screen shown below appears.

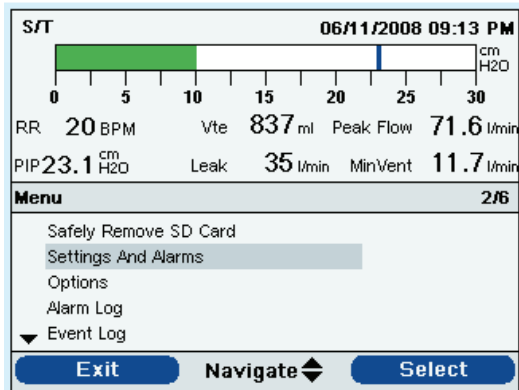

Choose from the following selections on the Main Menu screen:

- Safely Remove SD Card - This option will appear if an SD card is inserted in the ventilator. Select this option when you want to remove the SD card. When the “Remove SD Card” confirmation message appears, remove the card. If you press the left (cancel) button or don’t remove the card within 30 seconds, the confirmation message will close and the ventilator will continue writing to the card.
- Settings and Alarms: View and change prescription settings and alarms.
- Options: View and change device settings, such as Full or Limited Access mode, Detailed View, Language, etc.
- Alarm Log: View a list of the 20 most recent alarms that have occurred.
- Event Log: View a list of all events that have occurred, such as ventilator setting changes, ventilator inoperative conditions, alarms, etc.
- Information: View detailed information about the device, such as the device’s software version and serial number.

**Note:** For some therapy settings, once you reach the highest or lowest setting available, pressing the Up/Down button again will cycle back through the settings. For the parameters that do not wrap, when you reach the highest or lowest setting possible, a “Limit Reached” message appears in the Menu Banner on-screen.



### Main Menu Screen Example

**Note:** In the example Main Menu screen shown, the 2/6 that appears in the Menu banner indicates that item 2 is highlighted from a total of 6 items in the menu.

**Note:** If you change a setting but decide you do not want to save it, you can press the Left button to cancel the change.

## Changing the Device Settings and Alarms

From the Main Menu screen, use the Up/Down button to highlight the Settings and Alarms menu, and press the **Right** button to select the menu.

### Device Settings

Some of the settings on this menu will vary depending on the therapy mode you select. The section below describes all of the settings that are common to all therapy modes. Refer to the Therapy Modes Table in Chapter 3 for settings that are specific to each mode.

### Dual Prescription Setting

You can turn the dual prescription setting on or off. Enable the setting if you want to create two separate prescriptions for the patient. For instance, you may want to set up a daytime prescription and then a separate nighttime prescription. If you enable this setting, then the menu options on the Main Menu will change to include three new options:

- Switch to Primary/Secondary Settings
- Primary Settings and Alarms
- Secondary Settings and Alarms

The Main Menu screen will look like the screen below.

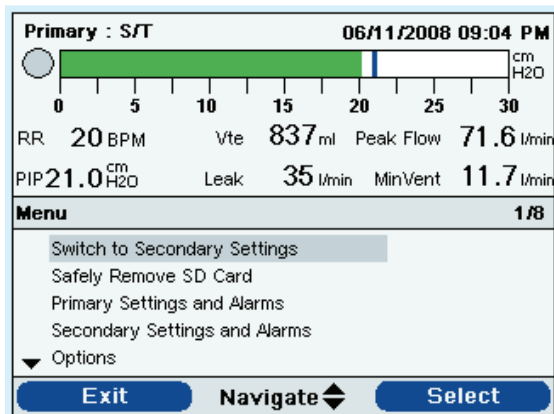

**Main Menu Screen with Dual Prescription Enabled**

**Note:** In the Options menu described later in this chapter, you can specify the Pressure Units displayed by the device, choosing either cm H<sub>2</sub>O, hPa, or mBar. The default setting is cm H<sub>2</sub>O, so this manual uses cm H<sub>2</sub>O throughout.

## Mode Setting

You can change the Mode setting on the Settings and Alarms screen to one of the following therapy modes:

- CPAP
- S
- S/T
- T
- PC
- PC-SIMV
- CV
- AC
- SIMV

## Circuit Type

There are two circuit types you can select:

- Passive
- Active PAP

The Passive circuit uses the a passive exhalation device. The Active PAP circuit uses an active exhalation device with a proximal air pressure sensing connection.

When using the Passive circuit, the ventilator displays estimated patient pressures based on the resistance of the standard patient circuit (Whisper Swivel II with 1.8 meter tubing). Adding accessories to the patient circuit (humidifier, water trap, etc.) may cause an increase in circuit resistance and cause the device to display slightly higher pressures than what is actually delivered to the patient.

With the Active PAP circuit, patient pressure is measured directly and is not affected by any change in circuit resistance.

**Note:** See Chapter 3 for detailed information about each therapy mode.

**Note:** Refer to the chart in Chapter 3 to easily review all of the settings available in each therapy mode.

**Note:** This chapter describes how to enable all of the device settings, including device alarms. For detailed information about each alarm, please refer to Chapter 6.

**Note:** To change the circuit type, you must be in the **Setup** screen with the airflow turned off. See the Full Menu Access Mode section for more information.

**Note:** When the Circuit Type setting is set to Passive Circuit, all Ramp Start Pressure settings in all modes will maintain the minimum range.

**Note:** When the Circuit Type setting is set to Active PAP Circuit, the Flex and AVAPS features are unavailable.

The Passive circuit provides leak compensation while the Active PAP circuit does not. When using the Passive circuit in Volume Ventilation, the set V<sub>ti</sub> is delivered to the patient above the calculated circuit and cuff (or mask) leak. This is different from traditional active circuit ventilation where the cuff (or mask) leak reduces the tidal volume delivered to the patient. Volume ventilation with the Passive circuit delivers an inspiratory tidal volume close to the device setting regardless of leak; this should be considered when transitioning a patient from an active to a passive circuit. With a Passive circuit, V<sub>te</sub> is estimated based on the calculated sum of circuit and cuff (or mask) leak.

### Circuit Disconnect

This setting enables or disables the circuit disconnect alarm. If enabled, an audible alarm will sound when a large, continuous air leak (such as mask removal) has been detected in the circuit.

You can choose **Off** to disable the alarm. Or, you can increase or decrease the setting from 5 to 60 seconds in 5 second increments. For example, a setting of 10 means that the alarm will sound after the circuit has been disconnected for 10 seconds.

### WARNING

*You should not rely on any single alarm to detect a circuit disconnect condition. The Low Tidal Volume, Low Minute Ventilation, Low Respiratory Rate, and Apnea alarms should be used in conjunction with the Circuit Disconnect alarm.*

### Low Vte

This setting enables or disables the Low Vte alarm. The alarm activates when the estimated exhaled tidal volume is less than or equal to this setting. You can choose **Off** to disable this alarm, or you can increase or decrease the setting from 40 ml to 2000 ml in 5 ml increments. It cannot be set higher than the High Vte setting.

When AVAPS is **On**, the alarm activates when the calculated tidal volume is less than 90% of the target tidal volume setting. This alarm can be set to on or off.

### High Vte

This setting enables or disables the High Vte alarm. The alarm activates when the estimated exhaled tidal volume is greater than or equal to this setting. You can choose **Off** to disable this alarm, or you can increase or decrease the setting from 50 ml to 2000 ml in 5 ml increments. It cannot be set lower than the Low Tidal Volume setting, except to be turned off.

### Low Vti

This setting enables or disables the Low Vti alarm. The alarm activates when the measured inhaled tidal volume is less than or equal to this setting. You can choose **Off** to disable this alarm, or you can increase or decrease the setting from 40 ml to 2000 ml in 5 ml increments. It cannot be set higher than the High Vti setting.

### High Vti

This setting enables or disables the High Vti alarm. The alarm activates when the measured inhaled tidal volume is greater than or equal to this setting. You can choose **Off** to disable this alarm, or you can increase or decrease the setting from 40 ml to 2000 ml in 5 ml increments. It cannot be set lower than the Low Vti setting, except to be turned off.

**Note:** The High and Low Vte alarms are only available when the Passive Circuit is selected.

**Note:** The High and Low Vti alarms are only available when the Active PAP Circuit is selected.

### Low Minute Ventilation

This setting enables or disables the Low Minute Ventilation alarm. The alarm activates when the calculated minute ventilation is less than or equal to this setting. You can choose **Off** to disable this alarm, or you can increase or decrease the setting from 0.1 l/min to 99 l/min.

**Note:** You can increase or decrease the Low Minute Ventilation setting in 0.1 l/min increments from 0.1 to 0.99 l/min and 1 l/min increments from 1 to 99 l/min.

### High Minute Ventilation

This setting enables or disables the High Minute Ventilation alarm. The alarm activates when the calculated minute ventilation reaches or exceeds this setting. You can choose **Off** to disable this alarm, or you can increase or decrease the setting from 1 l/min to 99 l/min in 1 l/min increments. It cannot be set lower than the Low Minute Ventilation setting except to be turned off.

### Low Respiratory Rate

This setting enables or disables the Low Respiratory Rate alarm. The alarm activates when the measured respiratory rate is less than or equal to this setting. You can choose **Off** to disable this alarm, or you can increase or decrease the setting from 4 BPM to 80 BPM in 1 BPM increments. It cannot be set higher than the High Respiratory Rate.

### High Respiratory Rate

This setting enables or disables the High Respiratory Rate alarm. The alarm activates when the measured respiratory rate reaches or exceeds this setting. You can choose **Off** to disable this alarm, or you can increase or decrease the setting from 4 BPM to 80 BPM in 1 BPM increments. It cannot be set lower than the Low Respiratory Rate except to be turned off.



## Low Inspiratory Pressure

This setting configures the Low Inspiratory Pressure alarm. It is only user-settable in CV, AC, and SIMV modes. It cannot be set lower than PEEP + 2 cm H<sub>2</sub>O or higher than the High Inspiratory Pressure. For passive circuits, you can increase or decrease the Low Inspiratory Pressure from 6 to 40 cm H<sub>2</sub>O in increments of 1 cm H<sub>2</sub>O. For active circuits, you can increase or decrease the setting from 2 to 40 cm H<sub>2</sub>O in increments of 1 cm H<sub>2</sub>O. For pressure modes, this alarm is not user-settable.

## High Inspiratory Pressure

This setting enables or disables the High Inspiratory Pressure alarm. It is only user-settable in CV, AC, and SIMV modes. The High Inspiratory Pressure cannot be set lower than the Low Inspiratory Pressure. You can increase or decrease the High Inspiratory Pressure from 10 to 80 cm H<sub>2</sub>O in increments of 1 cm H<sub>2</sub>O. For pressure modes, this alarm is not user-settable.

## CPAP

You can increase or decrease the CPAP pressure setting from 4 to 20 cm H<sub>2</sub>O in increments of 1.

## Ramp Length

The Ramp Length allows you to set the ramp time. You can disable Ramp by selecting Off, or you can increase or decrease the Ramp Length setting from 5 to 45 minutes in 5-minute increments.

## Ramp Start Pressure

You can increase or decrease the ramp start pressure in increments of 1 from 4 cm H<sub>2</sub>O to the CPAP pressure setting. The patient also has access to this setting, unless the ramp length is set to Off.

## Flex

You can enable or disable the Flex setting. **Off** disables the setting and prevents the patient from using Flex. To enable the setting, set Flex to 1, 2, or 3. The patient also has access to this setting, if Flex is enabled. The Flex feature is not available when using an active circuit type.

**Note:** If the CPAP pressure is set to 4 (the minimum setting), the Ramp Length setting will be unavailable.

**Note:** The Ramp Start Pressure setting will not display if the Ramp Length is set to Off or if the CPAP pressure is set to 4 cm H<sub>2</sub>O.

**Note:** Ramp Start Pressure is less than or equal to CPAP - 1 cm H<sub>2</sub>O in CPAP mode.

**Note:** In CPAP mode, Flex is only available when CPAP is greater than 4 cm H<sub>2</sub>O.

**Note:** Ramp Start Pressure is less than or equal to EPAP - 1 cm H<sub>2</sub>O in S, S/T, T, and PC modes.

**Note:** Ramp Start Pressure is greater than or equal to 0 cm H<sub>2</sub>O when the circuit type is Active PAP in S, S/T, T, and PC modes.

**Note:** Ramp Start Pressure is greater than or equal to 4 cm H<sub>2</sub>O when the circuit type is Passive in S, S/T, T, and PC modes.

**Note:** Ramp is not available in the Passive Circuit when IPAP = EPAP = 4 cm H<sub>2</sub>O or when IPAP Min = EPAP = 4 cm H<sub>2</sub>O.

**Note:** Flex is only available when Auto-Trak is enabled.

**Note:** Auto-Trak is only available if the Passive Circuit is selected.

**Note:** In S mode, Flex is only available when EPAP is greater than or equal to 4 cm H<sub>2</sub>O and IPAP is less than or equal to 25 cm H<sub>2</sub>O.

## Trigger Type

The device can be set to trigger breaths based on automatic flow thresholds or specific flow settings. You can select either **Auto-Trak** or **Flow Trigger** as the Trigger Type. When Auto-Trak is selected, the Auto-Trak trigger initiates based on automatic flow thresholds. When Trigger Type is set to Flow Trigger, Flow Trigger Sensitivity and Flow Cycle Sensitivity become active, and the trigger initiates based on the Flow Trigger Sensitivity setting.

### Flow Trigger Sensitivity

If you set the Trigger Type to Flow Trigger, the Flow Trigger Sensitivity setting displays. You can increase or decrease the setting from 1 to 9 l/min in 1 l/min increments.

The flow trigger initiates when the patient's inspiratory effort creates a flow equal to or greater than the flow sensitivity setting.

### Flow Cycle Sensitivity

If you set the Trigger Type to Flow Trigger, the Flow Cycle Sensitivity setting displays. You can increase or decrease the setting from 10 to 90 percent (%) in 1% increments.

As flow begins to decrease during inspiration, if the patient flow is less than the flow cycle set point, the device will cycle to expiration. For example: if the flow cycle is set at 75%, when the flow has decreased by 25% of the peak flow, the device will cycle to the EPAP/PEEP level.

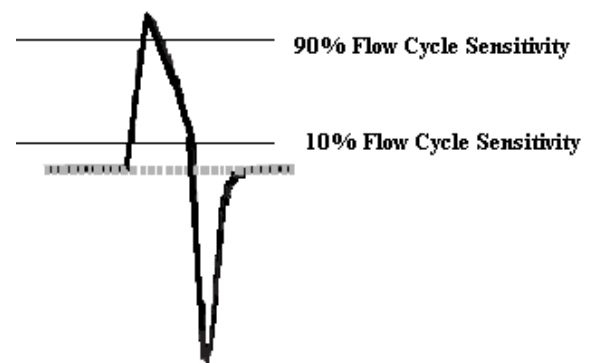

### Flow Cycle Sensitivity

**Note:** A flow cycle sensitivity set at 90% will result in the most sensitivity. If the flow cycle sensitivity is set at 10%, this will result in the least sensitivity.

**Note:** Trigger Type is not available when an Active PAP circuit is selected. Flow trigger is the triggering method used for Active PAP circuits.

## AVAPS

AVAPS is only available if Flex is not enabled.

You can disable AVAPS by selecting **Off**, or you can enable AVAPS by selecting **On**. If you select Off, the IPAP setting displays. If you select On, the IPAP Max Pressure and IPAP Min Pressure display.

## IPAP

The IPAP setting displays if AVAPS is Off. You can increase or decrease the Inspiratory Positive Airway Pressure (IPAP) from 4 to 50 cm H<sub>2</sub>O in increments of 1. IPAP is limited to a maximum of 25 cm H<sub>2</sub>O when Flex is enabled. You cannot set the IPAP setting lower than the EPAP setting.

### IPAP Max Pressure

The IPAP Max Pressure setting displays if AVAPS is enabled. You can increase or decrease the setting from 4 to 50 cm H<sub>2</sub>O in increments of 1. The IPAP Max Pressure must be equal to or greater than the IPAP Min value.

### IPAP Min Pressure

The IPAP Min Pressure setting displays if AVAPS is enabled. You can increase or decrease the setting from 4 to 50 cm H<sub>2</sub>O in increments of 1. The IPAP Min Pressure must be equal to or greater than the EPAP value, and it must be less than or equal to the IPAP Max Pressure.

## EPAP

You can increase or decrease the Expiratory Positive Airway Pressure (EPAP) from 4 to 25 cm H<sub>2</sub>O in increments of 1. For active circuits, EPAP can be set to zero.

When AVAPS is disabled, the EPAP setting must be less than or equal to the IPAP setting. When AVAPS is enabled, the EPAP pressure must be less than or equal to the IPAP Min Pressure.

**Note:** AVAPS is only available if the Passive Circuit is selected.

**Note:** IPAP, IPAP Max, or IPAP Min cannot be set to more than 30 cm H<sub>2</sub>O above EPAP.

**Note:** EPAP cannot be set to more than 30 cm H<sub>2</sub>O below IPAP, IPAP Max, or IPAP Min.

## Tidal Volume

The Tidal Volume setting displays if AVAPS is enabled. You can increase or decrease the setting from 50 to 2000 ml in 5 ml increments. Use this setting to establish the target volume of gas which the ventilator will produce and deliver during each Spontaneous breath.

## Rise Time

You can adjust the rise time to find the most comfortable setting for the patient. Increase or decrease the setting from 1 to 6 until you find the right setting. The rise time levels from 1 to 6 progressively reflect slowed response of the pressure increase that will take place at the beginning of inspiration.

## Apnea

This setting enables or disables the apnea alarm. If enabled, an audible alarm will sound when an apnea is detected. You can choose Off to disable the alarm. Or, you can increase or decrease the setting from 10 to 60 seconds in 5 second increments. For example, a setting of 10 means that the alarm will sound if the time between spontaneous breaths exceeds 10 seconds.

## Apnea Rate

If the Apnea alarm is enabled, you can set the Apnea Rate from 4 to 60 BPM in 1 BPM increments. In S mode, the Apnea Rate is greater than or equal to 1:2 I:E ratio.

## Breath Rate

In AC mode, you can increase or decrease the Breath Rate setting from 0 to 60 BPM, while in all other modes, you can increase or decrease the setting from 1 to 60 BPM in 1 BPM increments. Use the Breath Rate setting to establish the minimum rate of mandatory breaths that the ventilator will deliver per minute.

## Inspiratory Time

You can adjust the Inspiratory Time setting from 0.3 to 5.0 seconds in 0.1 second increments. Inspiratory Time is the duration for the inspiratory phase of a mandatory breath.

**Note:** In CV, AC, and SIMV modes, the tidal volume setting is limited by the Inspiratory Time, to maintain the system's minimum and maximum peak flows.

**Note:** The Rise Time setting only displays if Flex is disabled. If Flex is enabled, the device will use a rise time of 3.

**Note:** In S/T, PC, PC-SIMV, SIMV and AC modes, the Apnea Rate is greater than or equal to the Breath Rate and is limited by the current Inspiratory Time setting to maintain a minimum 1:1 I:E ratio.

**Note:** In volume modes, the Breath Rate range is limited by the current Inspiratory Time setting to maintain a minimum 1:1 I:E ratio.

**Note:** In pressure modes, the inspiratory time range is limited by the current Breath Rate setting to maintain a minimum 1:1 I:E ratio.

**Note:** In volume modes, the inspiratory time range is limited by the current Tidal Volume and Breath Rate settings to maintain a minimum 1:1 I:E ratio and the system's minimum and maximum peak flow.

## Inspiratory Pressure

You can increase or decrease the Inspiratory Pressure setting from 4 to 50 cm H<sub>2</sub>O in increments of 1. This is the pressure the ventilator will deliver during the inspiratory phase of a mandatory or assist breath.

## Pressure Support

You can increase or decrease the Pressure Support setting from 0 to 30 cm H<sub>2</sub>O in increments of 1. This is the pressure support the ventilator will deliver during the inspiratory phase of a Spontaneous breath.

## PEEP

The Positive End Expiratory Pressure (PEEP) setting can be increased from 0 to 25 cm H<sub>2</sub>O in active circuits and 4 to 25 cm H<sub>2</sub>O in passive circuits, in increments of 1. PEEP is the positive pressure maintained in the patient circuit during exhalation. The PEEP must be less than or equal to the pressure setting.

## Flow Pattern

You can choose either Ramp or Square for the Flow Pattern setting.

## Sigh

You can enable or disable the Sigh setting by selecting **On** or **Off**. A Sigh is a breath that is delivered every 100 breaths at 150% of the normal volume.

**Note:** In PC-SIMV mode, you cannot set up Pressure Support for Mandatory and Assist breaths (Pressure - PEEP) greater than 30 cm H<sub>2</sub>O.

**Note:** The Pressure Support and PEEP settings together cannot exceed 50 cm H<sub>2</sub>O.

**Note:** The Low Inspiratory Pressure is limited to PEEP +2 in CV, AC, and SIMV modes.

**Note:** The Flow Pattern setting might be limited to only Ramp or Square based on the Tidal Volume, Inspiratory Time, and Breath Rate settings to maintain the minimum and maximum peak flows.

**Note:** Flow Cycle Sensitivity is not available in AC mode.

## Viewing and Changing Options Menu Items

From the Main Menu screen, select the Options item.

The Options menu appears, shown in the screen below.

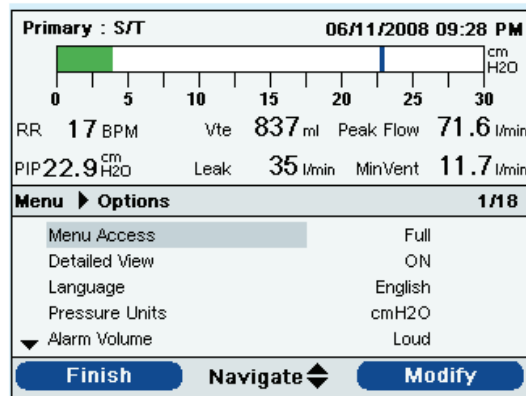

Options Menu

The following settings are available on the Options menu.

- **Menu Access** – You can select Full or Limited menu access. Full menu access allows operators to access all ventilator and prescription settings. Limited menu access allows operators to access only certain settings and does not allow them to change prescription settings. To prevent patients from changing prescription settings, do not give them Full menu access.
- **Detailed View** – You can turn Detailed View on or off using this setting. Detailed view displays additional settings and therapy information on the Monitor screen.
- **Language** – The next item on the Options menu allows you to select the Language that the software will appear in (English, French, German, etc.). The information on the screens will display in the language selected here.
- **Pressure Units** – The next item allows you to select the pressure units that will display on the screens. You can choose either:
  - cm H<sub>2</sub>O
  - hPa
  - mBar

All pressure units on the screens will display in the unit of measure selected here.

- **Alarm Volume** – You can adjust the volume of the device alarms using this setting. Select either Loud or Soft as the alarm volume options.
- **Keypad Lock** – You can enable or disable the Keypad Lock feature, which is described in detail earlier in this chapter. Enabling the Keypad Lock feature can prevent someone from accidentally pressing a button and changing any of the settings. Select On to enable the feature or Off to disable it.
- **Keypad Backlight** – The next item you can set is the Keypad Backlight. You can turn the backlight On or Off using this setting. Whenever you press the  button to begin therapy, the keypad backlight temporarily lights up. Once therapy is being provided, the keypad will be lit according to this Keypad Backlight setting. If the setting is On, the backlight remains on while therapy is provided. If the setting is Off, the backlight remains off while therapy is provided.
- **LCD Brightness** – The LCD display is lit by a backlight. The backlight turns on when the initial Startup screen displays. You can adjust the brightness of the LCD backlight from 1 – 10, with 1 being the dimmest setting and 10 being the brightest.
- **Screen Saver** – You can change the screen saver to reduce power consumption or dim the screen in a dark room. You can choose the following settings:
  - Off: No screen saver displays and the LCD backlight remains lit at your brightness setting.
  - Breath: The display appears as a black screen, with only the patient breath indicator and manometer visible.
  - Black: The display's backlight is turned off and the display is black with no information visible.

 **WARNING**

*Make sure the alarm volume is set loud enough to be heard by the caregiver. Consider the use of a remote alarm, or nurse call.*

**Note:** *Setting the screen saver to Black allows the device to run for a longer period of time on battery power.*

- **Dim:** The display's backlight is decreased, so that the display is still visible but not as bright.

If enabled, the screen saver will display after 5 minutes of no keypad activity. Pressing any button on the device will exit the screen saver. And, any alarm or informational message will also exit the screen saver

- **Date Format** – You can choose either mm/dd/yyyy or dd/mm/yyyy as the date format that will display on the device screens.
- **Time Format** – You can choose to display either an AM/PM time format or 24 Hour time format (for example, 2:49 PM or 14:49).
- **Month** – The month defaults to the current month. The adjustable range is from 1 (January) – 12 (December).
- **Day** – The day defaults to the current day. The adjustable range is from 1 – 31. The maximum value is based on the selected month.
- **Year** – The year defaults to the current year. The adjustable range is from 2000 – 2099.
- **Hour** – The hour defaults to the current hour. The adjustable range is from 12 AM – 12 PM or 0-23, depending on the selected Time Format.
- **Minute** – The minute defaults to the current minute. The adjustable range is from 0 – 59.
- **IP Address Mode** – You can change the IP address mode to either DHCP or Static, depending on the type of network you are using (if applicable).



- **Operational Hours** – The operational hours displays the total number of hours that the device blower has been on since the last time this value was reset. You can reset this value to zero (0) if desired (e.g., each time you give the device to a new patient). This value helps you determine how often the patient is using the device. The Operational Hours shown here differs from the Blower Hours shown on the Information screens. The Blower Hours displayed in the Information screen is the total number of hours that the blower has been working over the life of the device. You cannot reset this value.

## Viewing the Alarm Log

From the Main Menu screen, you can select Alarm Log to access the Alarm Log screen. An example is shown below.

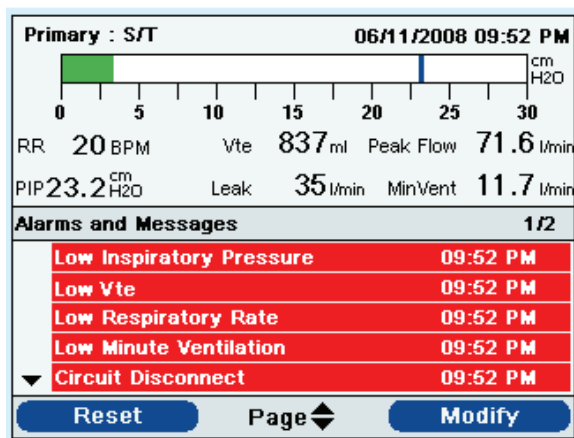

**Note:** In the Alarm Log screen, the 1/2 shown in the Menu banner indicates that page 1 of 2 alarm log pages is being viewed at this time.



### Alarm Log Screen

**Note:** In Full Menu access mode, you can press the Right (Clear) button to clear the alarm log if desired.

The alarm log displays the alarms in chronological order with the most recent events displayed first. It lists the 20 most recent alarms or messages that appeared on the device display. When the device is in Limited Menu access mode, the alarm log cannot be cleared. It can be cleared when in Full Menu access mode. Depending on how many alarms have occurred, the alarm log may be several pages long. The entries in the alarm log use the same names that displayed when the alarm initially occurred and was displayed in the Alarm View.

## Viewing the Event Log

From the Main Menu screen, you can select Event Log to access the Event Log screen.

The event log displays a list of all events that have occurred, such as ventilator setting changes, ventilator inoperative conditions, alarms, etc., in chronological order with the most recent events displayed first. When the device is in Limited Menu access mode, the event log is not available. It can be viewed and cleared when in Full Menu access mode. You can page through the event log if it is multiple pages. The number of pages appears in the upper right corner of the panel.

**Note:** In Full Menu access mode, you can press the Right (Clear) button to clear the event log if desired.

In the event log descriptions, any description beginning with a **1:** or **2:** is a prescription change event. The 1 represents a change to a primary setting and the 2 represents a change to a secondary setting. This is followed by the setting that was changed.

The last two columns indicate setting and alarm changes. If the entry is a setting change, the first column shows the old setting value and the last column shows the new setting. If the entry is an alarm, the first column shows the value that triggered the alarm and the last column shows the number of seconds that the alarm was active.

## Viewing Device Information

From the Main Menu screen, you can select Information to access the Information screen. You can also view the Information screen by holding the **Down** key for 5 seconds. This causes the detailed view of the Monitor Screen and the Information Menu to be displayed temporarily. This key sequence is valid from the Monitor Screen while in Full or Limited Access.

The Information screen provides you with a summary of the current prescription settings, device settings, and system settings. You can use the Up/Down buttons to scroll through the information.

## Updating Prescriptions Using the SD Card

With the **Trilogy100**, you can update the patient's prescription using the SD Card. This feature lets you update a single prescription or both prescriptions if the dual prescription feature is enabled. The prescription update can occur either when the ventilator is off or on.

1. Insert an SD Card with a valid prescription into the device. A **"Change Prescription?"** message appears on the display.
2. Select **No** to cancel the prescription update process and return to the previous display (the black screen if the airflow was off or the Monitor/Standby screen if the airflow was on). Select **Yes** to start the prescription update process. Once the prescription is read in and validated, one of the following screens appears on the display to allow you to ensure the prescription is correct:

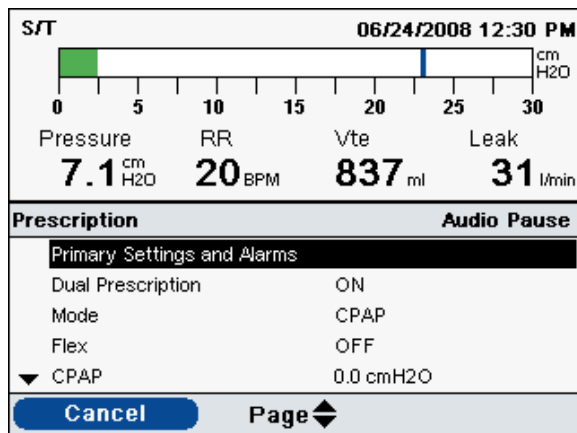
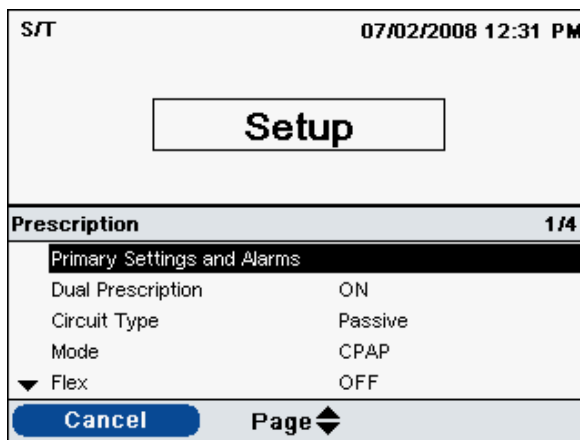

### WARNING

When you change the device prescription, alarms and other settings using the SD card, **Trilogy100** requires that the caregiver review and verify the changes prior to the changes being used by the device. The caregiver or health care professional is responsible to ensure that the prescription settings are correct and compatible with the patient after using this feature. Installing the wrong prescription for a particular patient may result in improper therapy, lack of appropriate safety monitoring, and risk of death or injury to the patient.



### Ventilator Off Prescription Display Screen



### Ventilator On Prescription Display Screen

3. Select **Cancel** to cancel the prescription update process and return the screen to the initial state before the prescription update started. Select **Page** to review the entire prescription. The Menu Banner will reflect the prescription being updated.
4. Select **Cancel** to cancel the prescription update process and return the screen to the initial state before the prescription update started. Select **OK** to complete the prescription update and display the Prescription Change confirmation screen.

If the SD card is removed at any time during the prescription update, the process aborts and the screen returns to the initial state before the prescription update started.

A confirmation screen will appear if errors occur during this process. The following table summarizes the prescription errors, their possible causes, and the actions to take.

**Note:** Make sure you closely review the prescription and confirm that all settings are correct.

**Note:** If both prescriptions of a dual prescription are being updated, you must accept the primary prescription using the **OK** button before being able to review the secondary prescription. Both prescriptions have to be accepted before any changes are made.

Message	Cause	Action
Prescription Change Failed	Displayed when an error occurs during the prescription update. This is caused by an attempt to set a value for a prescription parameter that is not valid for the therapy mode or an attempt to set a prescription parameter to an invalid value.	Remove the card and have the prescription replaced with a valid prescription.
Prescription Failed – Circuit Type	Displayed when the circuit type in the new prescription doesn't match the circuit type set for the ventilator.	If the circuit type in the prescription is correct, remove the card, change the circuit type on the ventilator, and re-insert the card. If the circuit type on the ventilator is correct, remove the card and replace the prescription on the card with a prescription containing the correct circuit type.
Prescription Failed – Card is Read Only	Displayed when the prescription is write-protected.	Remove the card and check that the small switch on the side of the SD Card is not in the Locked position. If you continue to receive this message, remove the card and have the prescription replaced with a valid prescription.
Prescription Failed – Serial Number	Displayed when the device serial number on the new prescription does not match the serial number for the device on a single-use prescription.	Remove the card and have the prescription replaced with the prescription with the correct serial number.
Prescription Failed – Version	Displayed when the version of the prescription does not match the version accepted by the device.	Remove the card and have the prescription replaced with a prescription in the correct version.

## Changing and Viewing Settings in Limited Menu Access Mode

After you press the  button and access the Monitor screen, you can view and change settings using the Menu screens.

To enter the Menu screens from the Monitor screen, press the Up button on the ventilator. The Main Menu screen appears, shown below.

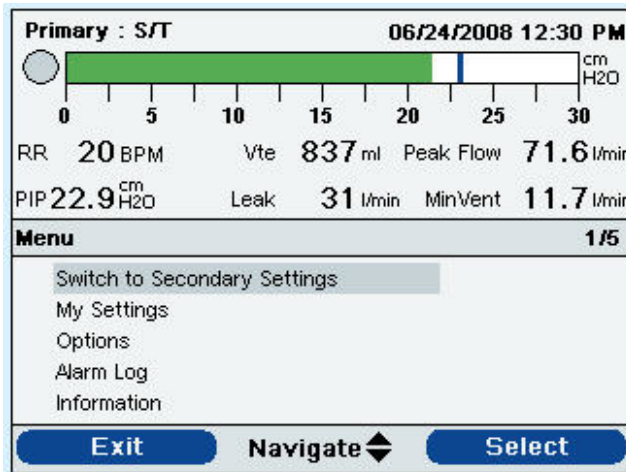

You can choose from the following selections on the Main Menu screen:

- **Switch to Primary (or Secondary) Settings:** If your health care professional has set up a dual prescription for you, this option will appear. You can select it to change to either your Primary or Secondary prescription settings.
- **Safely Remove SD Card:** This option will appear if an SD card is inserted in the ventilator. Select this option when you want to remove the SD card. When the “Remove SD Card” confirmation message appears, remove the card. If you press the left (cancel) button or don’t remove the card within 30 seconds, the confirmation message will close and the ventilator will continue writing to the card.

**Note:** If the Keypad Lock feature is enabled, a message will appear that says “Hold Right Key for 5 seconds to unlock.” Once you hold the key down for 5 seconds, the keypad will unlock and you can enter the Main Menu screen. The Keypad Lock feature is explained in detail later in this chapter.

**Note:** In the example Main Menu screen shown, the 1/5 that appears in the Menu banner indicates that item 1 is highlighted from a total of 5 items in the menu.



Main Menu Screen

- **My Settings:** View and change certain prescription settings, such as rise time or ramp starting pressure, if these settings were enabled by your health care professional.
- **Options:** View and change certain device settings, such as your alarm volume, keypad lock, or keypad backlighting.
- **Alarm Log:** View a list of the 20 most recent alarms that have occurred.
- **Information:** View detailed information about your device, such as the device's software version and serial number.

**Note:** The Options, Alarm Log, and Information items are discussed in detail earlier in this chapter, in the "Changing and Viewing Settings in Full Menu Access Mode" section.

## Activating Your Primary or Secondary Prescription

If your health care professional has set up a dual prescription for you, follow the steps below to change your prescription selection. Your health care professional might use this feature if, for instance, you need one prescription for daytime use and a second, different prescription for nighttime use.

**Note:** If you are currently using the primary prescription, the menu option will say "Switch to Secondary Settings." If you are currently using the secondary prescription, the option will say "Switch to Primary Settings."

1. Use the Up/Down (Navigate) button to highlight the "Switch to Primary (or Secondary) Settings" option.
2. Press the **Right** (Select) button.

A screen like the one shown below appears with a confirmation message. The confirmation message will vary, depending on which prescription you are changing to.

3. Press the **Right** (Yes) button to switch to the new prescription. If you decide not to change the prescription, press the **Left** (No) button. The display returns to the Main Menu after you've made your selection.

## Viewing and Changing My Settings Menu Items

To view or change the therapy settings available on the My Settings screen, use the Up/Down (Navigate) button to highlight the My Settings option on the Main Menu, and press the Right (Select) button. The My Settings Menu screen appears, shown below.

Follow the general instructions below to navigate and change any of the therapy settings. Detailed information about each setting follows.

1. From the My Settings screen, use the Up/Down button to navigate to the setting you want to change and highlight it.
2. To modify a setting once it is highlighted, press the **Right** (Modify) button.
3. Use the Up/Down (Edit) button to scroll through the available settings. Press **Down** to decrease the setting, or press **Up** to increase the setting.
4. Once you have chosen the setting you want, press the **Right** (OK) button to save the new setting. Or, if you decide not to change the setting, press the **Left** (Cancel) button.
5. You can now either navigate to the next setting you want to change using the Up/Down (Navigate) button, or exit the My Settings menu by pressing the **Left** (Finish) button to return to the Main Menu.

You can change the following settings in the My Settings menu, if they are enabled by your health care professional.

- **Rise Time** – The Rise Time is the time it takes the ventilator to change from expiration to inspiration. If this feature is enabled, you can adjust the Rise Time from 1 to 6 to find the setting that provides you with the most comfort. A setting of 1 is the fastest Rise Time, while 6 is the slowest.
- **Ramp Start Pressure** – The ventilator is equipped with an optional Ramp feature. Ramp reduces the pressure and then gradually increases the pressure to your prescription setting so you can fall asleep more comfortably.

**Note:** The options on the My Settings screen will vary depending on how your health care professional has set up your device.

**Note:** For some therapy settings, once you reach the highest or lowest setting available, pressing the Up/Down button again will cycle back through the settings. For the parameters that do not wrap, when you reach the highest or lowest setting possible, a "Limit Reached" message appears in the Menu Banner on-screen.

**Note:** After you select "OK" to save the new setting, the next setting in the list is automatically highlighted.

**Note:** If some features or settings are not enabled on your ventilator, they will not appear on your My Settings screen. For instance, if Ramp is not enabled, the Ramp Start Pressure setting does not appear on the screen.



If your health care professional has enabled Ramp on your ventilator, you can adjust the Ramp Start Pressure setting. The setting can be adjusted from 4.0 to your prescription pressure setting in increments of 1.

- **Flex** – The optional Flex feature allows you to adjust the level of air pressure you feel when you exhale during therapy. If this feature is enabled by your health care professional, you can adjust the setting from 1 to 3.

**Note:** If the Flex feature is enabled, the Rise Time setting will **not** appear on your My Settings screen and cannot be adjusted. When Flex is enabled, the Rise Time is fixed at a setting of 3.

**Note:** When adjusting the Flex setting, it is recommended that you start with the minimum setting of 1, which provides the least relief. Levels 2 and 3 progressively increase the pressure relief.

**Note:** If you are using an active circuit, the Flex feature is unavailable.

**Note:** Flex is only available if Auto-Trak is enabled.

## Connecting the Ventilator to the Patient

After you have finished adjusting your ventilator settings, perform the following steps to connect the ventilator to the patient.

### 1. Perform System Checkout

Do not connect the ventilator to the patient until you perform the system checkout procedures defined in Chapter 10.

### 2. Start Therapy

Press the  button to begin therapy. When you start therapy, the display backlight and the backlights on the buttons turn on, the red and yellow alarm LEDs turn on momentarily, and an audible indicator sounds to indicate that therapy has started. The Startup screen appears on the display.

### 3. Connect the Breathing Circuit to the Patient Interface

After you have assembled the system, started therapy, and adjusted your ventilator settings as needed, you can connect the breathing circuit to the patient. The illustration below shows the breathing circuit connected to a mask. You can also connect the breathing circuit to a tracheostomy tube.

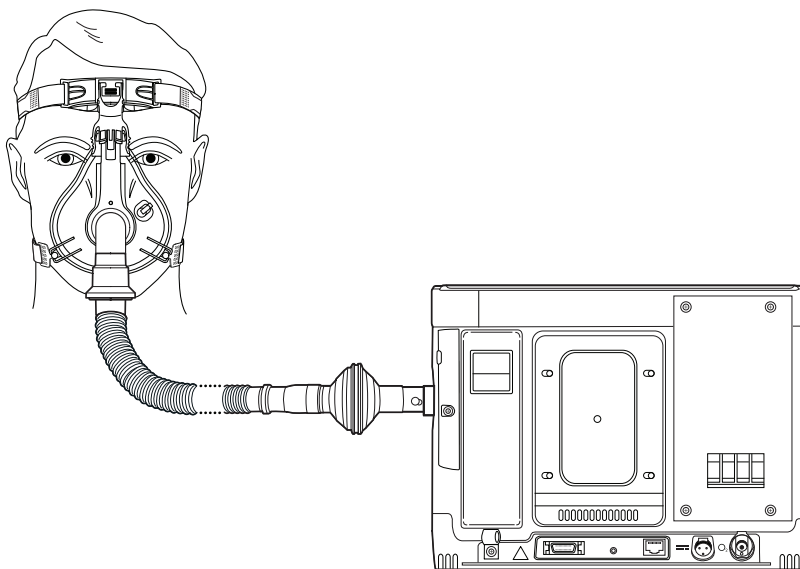

**Note:** *Trilogy100* provides features to control access to the device (prescription) settings and to transfer new device settings onto the device using the SD Card. These features are intended to be used as part of your clinical/institutional procedures governing the use, security, and control of this medical device.

### WARNING

To make sure the device is operating properly at start-up, always verify that the audible tone sounds and the alarm LEDs light red and then yellow momentarily. Contact Philips Respironics or an authorized service center for service if these indications do not occur at start-up.



**Example of a Fully Connected Patient Breathing Circuit with Passive Exhalation Device**



## 6. Ventilator Alarms

This chapter describes the ventilator alarms and what you should do if an alarm occurs.

There are three types of alarms:

- High Priority – Require immediate response by the operator
- Medium Priority – Require prompt response by the operator
- Low Priority – Require operator awareness. These alarms alert you to a change in the ventilator status.

Additionally, the ventilator also displays informational messages and confirmation alerts that notify you of conditions that need attention but do not qualify as alarm conditions.

**Note:** *If multiple alarms occur at the same time, all alarms are processed and displayed, but the alarms are ordered first by priority and then by occurrence, with the newest, highest priority alarms at the top of the list. The alarm precedence is in the following order: high priority, medium priority, low priority, and informational messages.*

**Note:** *Not all alarms are available in every therapy mode; some alarms are mode-dependent.*

## Audible and Visual Alarm Indicators

When an alarm condition occurs:

- The alarm LED indicator on the Alarm Indicator/Audio Pause button lights
- The audible alarm sounds
- A message appears on the screen describing the type of alarm
- The remote alarm (if applicable) is activated

Each of these is described in detail below.

### Alarm LED Indicators

The Alarm Indicator/Audio Pause button on the front of the ventilator lights up as follows whenever an alarm is detected:

- Red Flashing Indicator – When the device detects a high priority alarm, the Alarm Indicator/Audio Pause button flashes red.
- Yellow Flashing Indicator – When the device detects a medium priority alarm, the Alarm Indicator/Audio Pause button flashes yellow.
- Yellow Solid Indicator – When the device detects a low priority alarm, a solid yellow light appears on the Alarm Indicator/Audio Pause button.

The Alarm Indicator/Audio Pause button does not light up when informational messages or confirmation alerts display.



**Alarm Indicator/Audio Pause Button**

## Audible Indicators

An audible indicator sounds whenever a power failure or a high, medium, or low priority alarm is detected. Additionally, an audible indicator sounds for informational messages and to confirm that certain actions have occurred (for example, when an SD card is inserted or removed from the device).

- Ventilator Inoperative Audible Indicator – When a ventilator inoperative alarm occurs, a continuous audible alarm sounds. The alarm descriptions later in this chapter display this indicator as: ██████████
- Power Failure Audible Indicator – When a power failure occurs, a series of beeps sounds in a 1 beep pattern, repeating one second on, then one second off. The alarm descriptions later in this chapter display this indicator as:
  - •
- High Priority Audible Indicator – When a high priority alarm is detected, a series of beeps sound in the following pattern, which is repeated twice: 3 beeps, a pause, and then 2 more beeps. This indicator continues until the cause of the alarm is corrected or the audible alarm is paused. The alarm descriptions later in this chapter display this indicator as:
  - • • • • • • •
- Medium Priority Audible Indicator – When a medium priority alarm is detected, a series of beeps sound in a 3-beep pattern. This pattern repeats until the cause of the alarm is corrected or the audible alarm is paused. The alarm descriptions later in this chapter display this indicator as: • • •
- Low Priority Audible Indicator – When a low priority alarm is detected, a series of beeps sound in a 2-beep pattern. This pattern repeats until the cause of the alarm is corrected or the audible alarm is paused. The alarm descriptions later in this chapter display this indicator as:
  - •

**Note:** For the alarm indicators noted throughout this manual, each “dot” represents an audible beep.

- Informational Messages and Confirmation Audible Indicators – When an informational message appears on screen, a brief, 1- beep audible indicator sounds. Additionally, when the device detects that a certain action has been completed (for example, when the Start/Stop button is pressed to start therapy, or when an SD card is inserted or removed from the device) a brief, 1- beep audible indicator sounds. The alarm descriptions later in this chapter display this indicator as: •

## Alarm Messages

When the ventilator detects an alarm, the Alarms and Messages Screen is displayed showing a description of the alarm condition. When an alarm message appears, it will be highlighted in red if it is a high priority alarm or in yellow if it is a medium or low priority alarm. (The highlight color matches the alarm LED color on the Alarm Indicator/Audio Pause button.) If an alarm is manually reset by the user, the Alarms and Messages screen is removed and the Monitoring Screen is re-displayed. If the alarm self-cancels, the Alarms and Messages screen remains displayed, but the highlight for the active alarm is removed, the LED is unlit, and the audible alarm stops. The screen below is an example of a possible alarm message.

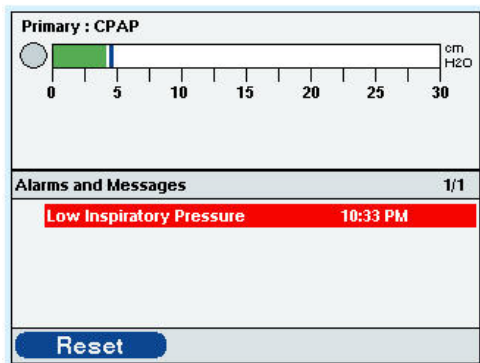

**Note:** An alarm message will also display in the Menu Banner if a menu is active when an alarm occurs.



Sample Alarms and Messages Screen

If a menu is displayed on the screen when an alarm occurs, the description of the newly generated alarm is displayed in the menu banner area. This is done so that the modification to the current parameter can be completed before addressing the alarm condition in case the modification affects the alarm condition. The screen below is an example of an alarm message displayed in the menu banner.

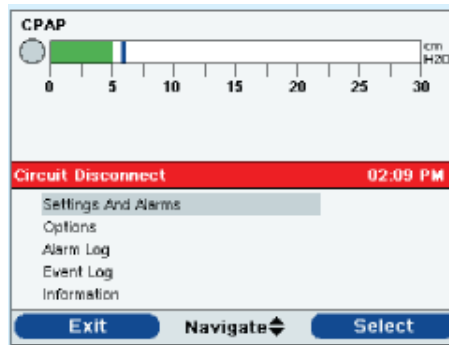

**Alarm in Menu Banner Screen**

The Alarms and Messages Screen will automatically display in place of the Monitor screen when exiting from the menu system using the Exit soft key when an alarm is displayed in the menu banner. If an alarm is manually reset by the user or self-cancels, the menu banner on-screen before the alarm occurred will reappear.

If a Ventilator Inoperative alarm occurs, the entire display screen turns red and the Ventilator Inoperative message appears on-screen, as shown below.



**Ventilator Inoperative Alarm Screen**



To turn the ventilator off from a Ventilator Inoperative condition, use the normal power off sequence. When the Start/Stop button is selected, the following screen will display.

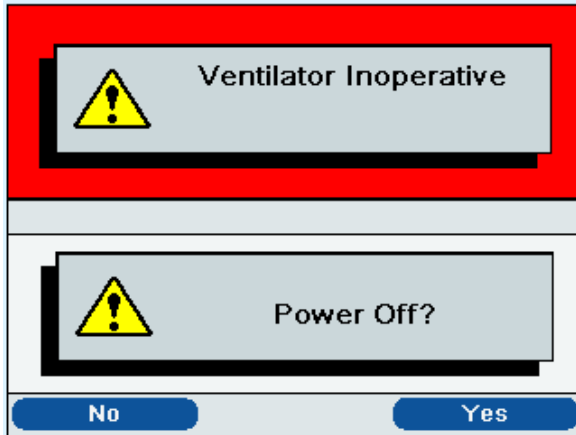

**Ventilator Inoperative Power Off Screen**

Select the Right button (Yes) to turn the ventilator off and stop the audible alarm. Selecting the Left button (No) will return the screen to the Ventilator Inoperative Alarm Screen without silencing the audible alarm.

## Remote Alarm

When the ventilator detects an alarm condition, if you are using a remote alarm system, a signal is sent from the ventilator to activate the remote alarm. The Remote Alarm is discussed in Chapter 9.

## Audio Pause and Alarm Reset Features

This section describes the Audio Pause and Alarm Reset features.

### Audio Pause

When an alarm occurs, you can temporarily silence the audible indicator by pressing the Alarm Indicator/Audio Pause button. The alarm is silenced for 60 seconds and then will sound again if the cause of the alarm has not been corrected. Each time the Alarm Indicator/Audio Pause button is pressed, the alarm silence period resets to one minute.

When Audio Pause is active, the Alarm Indicator/Audio Pause symbol (  ) appears if you are on the Monitor screen. Additionally, an "Audio Pause" message displays in the menu banner on the Alarm Display screen.

You can 'pre-silence' alarms that have not yet occurred by pressing the Alarm Indicator/Audio Pause button while no alarms are active. Then, if an alarm occurs, the audible indicator does not sound until the Audio Pause time limit has expired. This can be useful during patient setup, so caregivers can prevent alarms from sounding that they know will occur during the setup process. The LED and display will still show the alarm, but the audible alarm will not sound.

### Alarm Reset

The Reset button is used to clear the currently active alarm(s) from the display and stop the LED and audible alarm indicator. This button should be selected after the situation causing the alarm(s) has been corrected. All active alarms are cancelled and alarm detection is restarted when this button is selected.

The ventilator self-cancels certain alarms if the cause of the alarm is corrected, shutting off the alarm LED, the audible alarm, and the alarm background color. However, the alarm text remains on the screen. You can manually reset an alarm by pressing the Left button (Reset). The Audio Pause function is cancelled if the alarm is manually reset.

## Alarm Volume Control

As explained in Chapter 5, you can adjust the Alarm Volume from the Options menu. You can select Loud or Soft, depending on your preference.

## What to Do When An Alarm Occurs

Complete the following steps when an alarm occurs:

1. Whenever an alarm occurs, first always observe the patient and ensure that adequate ventilation and oxygenation (if appropriate) are available.
2. Look at the alarm indicators and listen to the audible alarm sound. Note the color of the Alarm Indicator/Audio Pause button (red or yellow) and whether the LED is solid or flashing.
3. Look at the display to check the alarm message that appears on-screen and whether it is highlighted in red or yellow.
4. Press the Alarm Indicator/Audio Pause button to temporarily silence the audible alarm. A visual indicator displays if you are on the Monitor screen (  ), or an "Audio Pause" message appears in the menu banner on the Alarm Display screen.
5. Look up the alarm in the alarm descriptions later in this chapter to determine the source of the alarm and the appropriate action.

### WARNING

*Make sure the alarm volume is set loud enough to be heard by the caregiver. Consider the use of a remote alarm, or nurse call.*

### WARNING

*You should not rely on any single alarm to detect a circuit disconnect condition. The Low Tidal Volume, Low Minute Ventilation, Low Respiratory Rate, and Apnea alarms should be used in conjunction with the Circuit Disconnect alarm.*

## Alarm Summary Table

The following table summarizes all of the high, medium, and low priority alarms and informational messages. See the Troubleshooting section for more information.

Alarm	Priority	Audible	Visual (Alarm Indicator Button and Display)	Device Action	User/Clinician Action
Loss of Power	High	• •	Red flashing button; Blank screen	Shuts down	<p><b>User:</b> Press Start/Stop button and then press Right button to silence alarm. If using AC power, try plugging device into alternate AC power source. If loss of power continues, switch to DC power by connecting a fully charged detachable or external battery to the device. If there is still no power, connect patient to alternate source of ventilation and contact your health care professional.</p> <p><b>Clinician:</b> Restore AC power. If alarm continues, connect a fully charged detachable or external battery to device to restore power. If alarm still continues, have the device serviced.</p>
Ventilator Inoperative	High	■	Red flashing button; "Ventilator Inoperative" message	Shuts down if can't provide therapy safely. Or, continues to operate at a limited level.	<p><b>User:</b> Press Start/Stop button. If display is operational, Power Off confirmation screen appears. Select Right button to shut off device and silence alarm. Immediately remove patient from ventilator and connect them to alternate source of ventilation. Contact your health care professional for service.</p> <p><b>Clinician:</b> Restore power. If alarm continues, have the device serviced.</p>

Alarm	Priority	Audible	Visual (Alarm Indicator Button and Display)	Device Action	User/Clinician Action
Ventilator Service Required	High	••• ••	Red flashing button; "Ventilator Service Required" message	Operates	<p><b>User:</b> Press Alarm Indicator/ Audio Pause button to silence alarm. Or, press Left (Reset) button to reset alarm. The alarm goes away until next reminder appears. Connect patient to alternate source of ventilation and contact your health care professional as soon as possible.</p> <p><b>Clinician:</b> If alarm continues, have the device serviced.</p>
Check Circuit	High	••• ••	Red flashing button; "Check Circuit" message	Operates	<p><b>User:</b> Press Alarm Indicator/ Audio Pause button to silence alarm. Or, press Left (Reset) button to reset alarm. Make certain the circuit type matches what is selected in the Setup Menu. Make sure there is no kinked or pinched tubing. Make sure tubing is properly attached. Make sure all tubing and exhalation devices are clean and free of condensation (refer to the Troubleshooting section – tubing condensation). If using Active Exhalation Device, make sure diaphragm is inserted correctly and is not wrinkled or kinked. If alarm continues, contact your health care professional.</p> <p><b>Clinician:</b> Verify patient status. Verify that breathing circuit setup is correct. Correct any errors. If alarm continues, have device serviced.</p>

Alarm	Priority	Audible	Visual (Alarm Indicator Button and Display)	Device Action	User/Clinician Action
Low Circuit Leak	High	• • • • •	Red flashing button; "Low Circuit Leak" message	Operates	<p><b>User:</b> Press Alarm Indicator/ Audio Pause button to silence alarm. Or, press Left (Reset) button to reset alarm. Check for occlusions in exhalation devices. Make sure exhalation device is clean and functioning properly. Refer to the Troubleshooting section if Low Circuit Leak alarm is sounding during nebulizer treatments. If alarm continues, contact your health care professional.</p> <p><b>Clinician:</b> Remove obstruction in leak device. If alarm continues, have the device serviced.</p>
High Expiratory Pressure	High	• • • • •	Red flashing button; "High Expiratory Pressure" message	Operates	<p><b>User:</b> Press Alarm Indicator/ Audio Pause button to silence alarm. Or, press Left (Reset) button to reset alarm. Make sure tubing is not kinked or pinched. Check patient's breath rate. If alarm continues, contact your health care professional.</p> <p><b>Clinician:</b> Check patient's tubing to make sure it is not kinked or pinched. If alarm continues, have device serviced.</p>
Low Expiratory Pressure	High	• • • • •	Red flashing button; "Low Expiratory Pressure" message	Operates	<p><b>User:</b> Press Alarm Indicator/ Audio Pause button to silence alarm. Or, press Left (Reset) button to reset alarm. Make sure tubing is not kinked or pinched. If alarm continues, contact your health care professional.</p> <p><b>Clinician:</b> Check patient's tubing to make sure it is not kinked or pinched. If alarm continues, have device serviced.</p>

Alarm	Priority	Audible	Visual (Alarm Indicator Button and Display)	Device Action	User/Clinician Action
High Internal Oxygen	High	••• ••	Red flashing button; "High Internal Oxygen" message	Continues to operate when internal oxygen concentration reaches 5% above ambient levels.	<p><b>User:</b> Press Alarm Indicator/ Audio Pause button to silence alarm. Or, press Left (Reset) button to reset alarm. Disconnect supplemental oxygen supply from the ventilator and contact your health care professional.</p> <p><b>Clinician:</b> Disconnect supplemental oxygen from device. Check external oxygen connection. If problem continues, have device serviced.</p>
Circuit Disconnect	High	••• ••	Red flashing button; "Circuit Disconnect" message	Operates	<p><b>User:</b> Press Alarm Indicator/ Audio Pause button to silence alarm. Or, press Left (Reset) button to reset alarm. Check breathing circuit and reconnect it if it has become disconnected, or fix the leak. If alarm continues to occur, contact your health care professional. If device will not exit circuit disconnect, switch to an alternate source of ventilation.</p> <p><b>Clinician:</b> Reconnect tubing or fix leak. If alarm continues, have device serviced.</p>
Apnea	High	••• ••	Red flashing button; "Apnea" message	Operates	<p><b>User:</b> Press Alarm Indicator/ Audio Pause button to silence alarm. Or, press Left (Reset) button to reset alarm. Continue using device. If using an active circuit, check proximal pressure line to ensure it is not pinched or has water condensation. Refer to the Troubleshooting section on tubing condensation. If alarm continues, contact your health care professional.</p> <p><b>Clinician:</b> Verify patient status.</p>

Alarm	Priority	Audible	Visual (Alarm Indicator Button and Display)	Device Action	User/Clinician Action
High Vte	High	••• ••	Red flashing button; "High Vte" message	Operates	<p><b>User:</b> Press Alarm Indicator/ Audio Pause button to silence alarm. Or, press Left (Reset) button to reset alarm. Continue using device. If alarm continues, contact your health care professional.</p> <p><b>Clinician:</b> Verify patient status.</p>
Low Vte	High	••• ••	Red flashing button; "Low Vte" message	Operates	<p><b>User:</b> Press Alarm Indicator/ Audio Pause button to silence alarm. Or, press Left (Reset) button to reset alarm. Continue using device. If alarm continues, contact your health care professional.</p> <p><b>Clinician:</b> Verify patient status.</p>
High Vti	High	••• ••	Red flashing button; "High Vti" message	Operates	<p><b>User:</b> Press Alarm Indicator/ Audio Pause button to silence alarm. Or, press Left (Reset) button to reset alarm. Continue using device. If alarm continues, contact your health care professional.</p> <p><b>Clinician:</b> Verify patient status.</p>
Low Vti	High	••• ••	Red flashing button; "Low Vti" message	Operates	<p><b>User:</b> Press Alarm Indicator/ Audio Pause button to silence alarm. Or, press Left (Reset) button to reset alarm. Continue using device. If alarm continues, contact your health care professional.</p> <p><b>Clinician:</b> Verify patient status.</p>



Alarm	Priority	Audible	Visual (Alarm Indicator Button and Display)	Device Action	User/Clinician Action
High Respiratory Rate	High	••• ••	Red flashing button; "High Respiratory Rate" message	Operates	<p><b>User:</b> Press Alarm Indicator/ Audio Pause button to silence alarm. Or, press Left (Reset) button to reset alarm. Continue using device. If alarm continues, contact your health care professional.</p> <p><b>Clinician:</b> Verify patient status.</p>
Low Respiratory Rate	High	••• ••	Red flashing button; "Low Respiratory Rate" message	Operates	<p><b>User:</b> Press Alarm Indicator/ Audio Pause button to silence alarm. Or, press Left (Reset) button to reset alarm. Continue using device. If alarm continues, contact your health care professional.</p> <p><b>Clinician:</b> Verify patient status.</p>
High Inspiratory Pressure	Escalates from Audible indicator to Medium priority and then High priority	<ul style="list-style-type: none"> <li>• (for first two consecutive occurrences)</li> <li>••• (for 3rd consecutive occurrence)</li> <li>••• •• (for 10th consecutive occurrence)</li> </ul>	<p>Peak Pressure symbol turns red. When condition first occurs, a beep will sound. When condition occurs for third time, button flashes yellow and yellow "High Inspiratory Pressure" message appears. When condition occurs for 10th time, button flashes red and red "High Inspiratory Pressure" message appears.</p>	Operates	<p><b>User:</b> Press Alarm Indicator/ Audio Pause button to silence alarm. Or, press Left (Reset) button to reset alarm. Make sure tubing is not pinched or blocked. If alarm continues, contact your health care professional.</p> <p><b>Clinician:</b> Verify patient status. If problem continues, have device serviced.</p>

Alarm	Priority	Audible	Visual (Alarm Indicator Button and Display)	Device Action	User/Clinician Action
Low Inspiratory Pressure	High	• • • • •	Red flashing button; "Low Inspiratory Pressure" message	Operates	<p><b>User:</b> Press Alarm Indicator/ Audio Pause button to silence alarm. Or, press Left (Reset) button to reset alarm. Check patient circuit for leaks or disconnects. If using an active circuit, check proximal lines to ensure they are not pinched or have water condensation (refer to the Troubleshooting section – tubing condensation). If alarm continues, contact your health care professional.</p> <p><b>Clinician:</b> Verify patient status. If problem continues, have device serviced.</p>
High Minute Ventilation	High	• • • • •	Red flashing button; "High Minute Ventilation" message	Operates	<p><b>User:</b> Press Alarm Indicator/ Audio Pause button to silence alarm. Or, press Left (Reset) button to reset alarm. Continue using device. If alarm continues, contact your health care professional.</p> <p><b>Clinician:</b> Verify patient status.</p>
Low Minute Ventilation	High	• • • • •	Red flashing button; "Low Minute Ventilation" message	Operates	<p><b>User:</b> Press Alarm Indicator/ Audio Pause button to silence alarm. Or, press Left (Reset) button to reset alarm. Continue using device. If alarm continues, contact your health care professional.</p> <p><b>Clinician:</b> Verify patient status.</p>

Alarm	Priority	Audible	Visual (Alarm Indicator Button and Display)	Device Action	User/Clinician Action
Low Battery	Escalates from Medium to High	<p>• • • (Medium - when approx. 20 minutes remains)</p> <p>• • • • • (High - when approx. 10 minutes remains)</p>	<p>Medium Priority- Yellow flashing button. "Low Detachable Battery," "Low External Battery," or "Low Internal Battery" message appears in yellow. On Status Panel, box around battery is yellow</p> <p>High Priority-Red flashing button. "Low Detachable Battery," "Low External Battery," or "Low Internal Battery" message appears in red. On Status panel, box around battery is red</p>	Operates	<p><b>User:</b> Press Alarm Indicator/ Audio Pause button to silence alarm. Or, press Left button (Reset) to reset alarm. Switch to an alternate battery. Or, switch to AC power source and recharge low battery.</p> <p><b>Clinician:</b> Switch to alternate battery or AC power while you recharge low battery. If low battery is recharged and alarm continues, replace battery.</p>
High Temperature	Escalates from Medium to High	<p>• • • for Medium • • • • • for High</p>	Yellow flashing button and yellow "High Temperature" message appears. If condition worsens, button flashes red and red "High Temperature" message appears.	Operates	<p><b>User:</b> Press Alarm Indicator/ Audio Pause button to silence alarm. Or, press Left (Reset) button to reset alarm. Make sure device is not close to a heat source. Make sure tubing is not under any bedding. Check inlet filter and clean or replace it if needed. Make sure cooling vents are not blocked. If the ventilator is running off of the internal or detachable battery, move to a cooler location and/or power the device with AC power or a lead-acid battery.</p> <p>If alarm continues, place patient on alternate source of ventilation and contact your health care professional.</p> <p><b>Clinician:</b> If alarm continues after the measures above have been taken, have device serviced.</p>

Alarm	Priority	Audible	Visual (Alarm Indicator Button and Display)	Device Action	User/Clinician Action
Replace Detachable Battery	Low or High, depending on cause of alarm	•• for Low •••• for High	"Replace Detachable Battery" message appears. If battery is nearing end of useful life, message appears with yellow background and button is solid yellow. If battery fails, message appears with red background and button flashes red.	Operates	<p><b>User:</b> Press Alarm Indicator/ Audio Pause button to silence alarm. Or, press Left button (Reset) to reset alarm. Switch to an alternate battery or AC power source while replacing current detachable battery.</p> <p><b>Clinician:</b> Switch to an alternate battery or AC power source while replacing the current detachable battery.</p>
AC Power Disconnected	Medium	•••	Yellow flashing button; "AC Power Disconnected" message, and a box appears around battery in use.	Switches to alternate power source	<p><b>User:</b> Press Alarm Indicator/ Audio Pause button to silence alarm. Or, press Left (Reset) button to reset alarm. If you were using AC power, check power cord and reconnect it if it has become disconnected. Make sure device is not connected to an overloaded AC circuit. If you were using an external, detachable, or internal battery, recharge the battery.</p> <p><b>Clinician:</b> Check batteries and recharge if necessary. Restore AC power if available.</p>
Keypad Stuck	Low	••	Solid yellow button; "Keypad Stuck" message.	Operates	<p><b>User:</b> Press Alarm Indicator/ Audio Pause button to silence alarm. Or, press Left (Reset) button to reset alarm. Check the keys to determine if they are lodged in the case. If alarm continues, place patient on alternate source of ventilation and contact your health care professional.</p> <p><b>Clinician:</b> Check keys to determine if they are lodged in the case. If alarm continues, place patient on alternate source of ventilation and have device serviced.</p>

Alarm	Priority	Audible	Visual (Alarm Indicator Button and Display)	Device Action	User/Clinician Action
Battery Discharging Stopped Due to Temperature	Info	•	"Batt Discharge Stopped – Temp." message	Operates	<p><b>User:</b> Press Alarm Indicator/ Audio Pause button to silence alarm. Or, press Left (Reset) button to reset alarm. Move device to a cooler location. Make sure device is not close to a heat source. Make sure cooling vents are not blocked. If alarm is detected for internal battery and continues, place patient on alternate source of ventilation and contact your health care professional.</p> <p><b>Clinician:</b> If alarm is detected on the internal battery and continues after the measures above have been taken, place patient on alternate source of ventilation and have device serviced.</p>
Battery Not Charging Due to Temperature	Info	•	"Batt Not Charging – Temp." message	Operates	<p><b>User:</b> Press Alarm Indicator/ Audio Pause button to silence alarm. Or, press Left (Reset) button to reset alarm. Make sure device is not close to a heat source. Make sure cooling vents are not blocked. Move device to a cooler location. If device is too cold, allow it to warm up. If alarm continues, place patient on alternate source of ventilation and contact your health care professional.</p> <p><b>Clinician:</b> If alarm continues after the measures above have been taken, place patient on alternate source of ventilation and have device serviced</p>

Alarm	Priority	Audible	Visual (Alarm Indicator Button and Display)	Device Action	User/Clinician Action
Battery Not Charging	Info	•	“Detach Battery Not Charging” or “Internal Battery Not Charging” message	Operates	<p><b>User:</b> Press Alarm Indicator/ Audio Pause button to silence alarm. Or, press Left (Reset) button to reset alarm. If condition continues for internal battery, place patient on alternate source of ventilation and contact your health care professional.</p> <p><b>Clinician:</b> If condition continues for internal battery, place patient on alternate source of ventilation and have device serviced.</p>
Check External Battery	Info	•	“Check External Battery” message	Operates	<p><b>User:</b> Press Alarm Indicator/ Audio Pause button to silence alarm. Or, press Left (Reset) button to reset alarm. Check connection to external battery. Replace external battery with another external battery, if available. If alarm continues, place patient on alternate source of ventilation and contact your health care professional.</p> <p><b>Clinician:</b> If the alarm continues after the measures above have been taken, place patient on alternate source of ventilation and have device serviced.</p>
Battery Depleted	Info	•	“External Battery Depleted” or “Detachable Battery Depleted” message appears	Operates	<p><b>User:</b> Press Alarm Indicator/ Audio Pause button to silence alarm. Or, press Left (Reset) button to reset alarm. Replace depleted battery with another or switch to AC power, if available.</p> <p><b>Clinician:</b> Replace depleted battery with another or switch to AC power.</p>

Alarm	Priority	Audible	Visual (Alarm Indicator Button and Display)	Device Action	User/Clinician Action
External Battery Disconnected	Info	•	"External Batt Disconnected" message, and a box appears around battery in use.	Switches to alternate power source	<p><b>User:</b> Check connection of the external battery to ventilator. Check the charge available on external battery and recharge battery if necessary.</p> <p><b>Clinician:</b> Check external battery and recharge if necessary. Restore AC power if available.</p>
Detachable Battery Disconnected	Info	•	"Detachable Batt Disconnected" message, and a box appears around battery in use.	Switches to alternate power source	<p><b>User:</b> Check connection of the detachable battery to ventilator. Check the charge available on detachable battery and recharge battery if necessary.</p> <p><b>Clinician:</b> Check detachable battery and recharge if necessary. Restore AC power if available.</p>
Start On Battery	Info	•	"Start On Battery" message appears.	Operates	<p><b>User:</b> Check battery status and determine how long device can operate on battery power. Find AC power source as soon as possible.</p> <p><b>Clinician:</b> Restore AC power when available. If alarm continues, replace AC power cord to determine if there is a problem with the cord.</p>

Alarm	Priority	Audible	Visual (Alarm Indicator Button and Display)	Device Action	User/Clinician Action
Card Error	Info	•	A "Card Error" message appears.	Operates	<p><b>User:</b> Press Alarm Indicator/ Audio Pause button to silence alarm. Or, press Left button (Reset) to reset alarm. Remove SD Card and use another card, if available. Check the write-protect switch on the card. If condition persists, contact your health care professional.</p> <p><b>Clinician:</b> Remove SD Card and use another card, if available. Ensure card meets specifications. Check write-protect switch on card. If condition persists, contact an authorized representative of Philips Respironics.</p>





# 7. Cleaning and Maintenance

## Cleaning the Ventilator

The ventilator's exterior surface and the exterior of the detachable battery pack (if using) should be cleaned before and after each patient use, and more often if needed.

1. Unplug the device and clean the front panel and exterior of the enclosure as needed using a clean cloth dampened with any of the following cleaning agents:
  - Water
  - Soapy water or a mild detergent
  - Hydrogen Peroxide (3%)
  - Isopropyl Alcohol (91%)
  - 10% bleach solution (10% bleach, 90% water)
2. Do not allow any liquid to drip into the ventilator case or detachable battery pack. After cleaning, use a soft, dry cloth to remove any residual cleaner. Use extra care when cleaning the display. Abrasive cleaners can scratch the display.
3. Allow the device to dry completely before plugging in the power cord.

 **WARNING**

*To avoid electrical shock, always unplug the power cord from the wall outlet before cleaning the ventilator.*

 **CAUTION**

*Do not immerse the device or allow any liquid to enter the enclosure or the inlet filter.*

 **CAUTION**

*Do not use harsh detergents, abrasive cleaners, or brushes to clean the ventilator system. Use only the cleaning agents and methods described in this manual.*

## Cleaning and Replacing the Air Inlet Filter

Under normal usage, you should clean the gray foam filter at least once every two weeks and replace it with a new filter every six months or sooner if needed.

1. If the device is operating, stop the airflow by pressing the  button. Disconnect the device from the power source.
2. Remove the filter from the enclosure by gently squeezing the filter in the center and pulling it away from the device, as shown below.

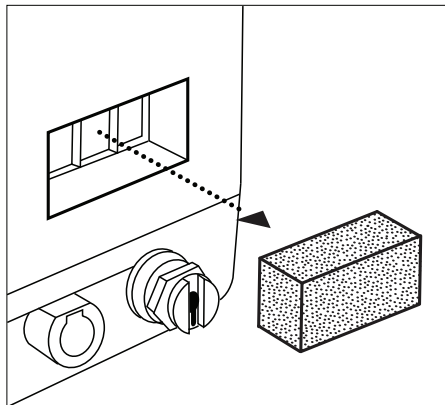

3. Examine the filter for cleanliness and integrity.
4. Wash the gray foam filter in warm water with a mild detergent. Rinse thoroughly to remove all detergent residue. Allow the filter to air dry completely before reinstalling it. If the foam filter is torn or damaged, replace it. Only Philips Respironics-supplied filters should be used as replacement filters.
5. Reinstall the filter as shown below.

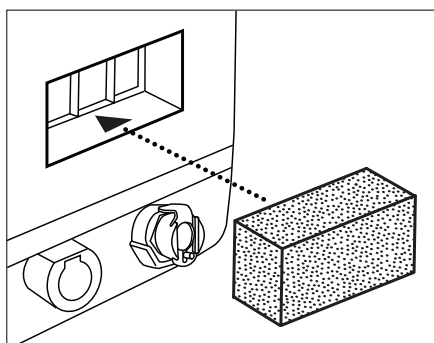

### CAUTION

*The reusable foam inlet filter is required to protect the ventilator from dirt and dust. Wash periodically and replace when damaged for proper operation.*



### Removing the Air Inlet Filter

**Note:** *Never install a wet filter into the device. It is recommended that you clean the filter in the morning and alternate using the two foam filters provided with the system to ensure sufficient drying time for the cleaned filter.*



### Reinstalling the Filter

## Replacing the Air Inlet Path Foam

Follow your institution's protocol for how often you replace the air inlet path foam. To replace the foam, complete the steps below.

1. Using a screwdriver, remove the air inlet path cover by unscrewing the four screws as shown below.

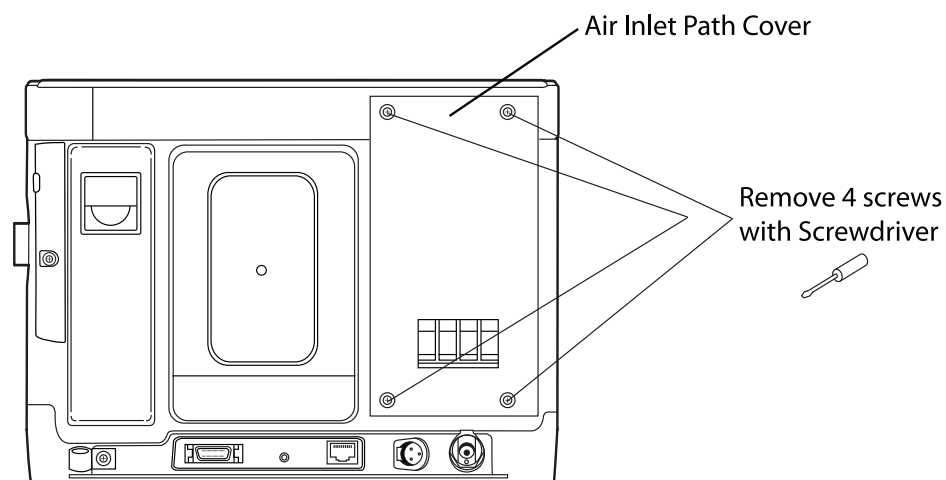

Removing the Air Inlet Path Cover

2. Remove the gray foam air inlet path by hand. The removed air inlet path is shown below.

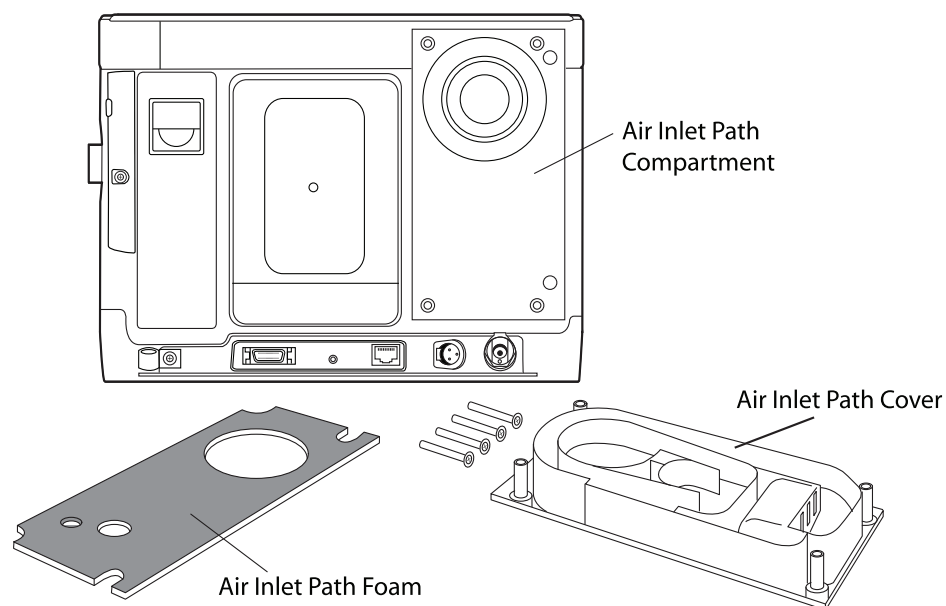

Removing the Air Inlet Path Foam

3. Insert the new air inlet path foam in the slot, lining the large circular cutout on the foam up with the circular connection at the top of the air inlet path compartment on the device. Make sure the air inlet path foam is securely in place.
4. Replace the air inlet path cover, using a screwdriver to secure each of the four screws. Make sure all of the screws are firmly in place.

## Cleaning the Patient Circuit

Cleaning the reusable circuit is important in the hospital and in the home. Circuits infected with bacteria may infect the user's lungs. Clean the respiratory circuit on a regular basis. If you are using a disposable circuit, dispose of and replace it on a regular basis.

Follow your institution's protocol for cleaning the circuit. Philips Respironics recommends that you perform the cleaning twice a week under normal conditions and more frequently as required. If the patient uses the device on a 24 hour a day basis, it may be convenient to have a second breathing circuit so you can switch circuits while one is being cleaned.

### Reusable Circuit Cleaning Instructions

Clean the patient circuit twice a week, or follow your institution's protocol.

1. Disconnect the circuit from the device, and disassemble the circuit for cleaning. Thoroughly wash your hands.
2. Using a mild detergent, such as liquid dishwashing soap, clean all accessible surfaces of the circuit. Do not clean using alcohol.
3. Rinse the circuit with tap water, removing all remaining detergent.
4. Prepare a solution of one part white vinegar to three parts distilled water. An average beginning quantity is 16 ounces vinegar to 48 ounces distilled water. The actual amount will vary according to individual needs. Regardless of the quantity the ratio must remain 1 part:3 parts. Soak the circuit in this solution for one hour. Rinse the circuit completely with tap water.

### CAUTION

*Exhalation valves, patient circuits, and water traps are shipped clean, not sterile. Cleaning and disinfection of these parts should follow individual institution processes and conform to guidelines provided by Philips Respironics with each accessory.*

5. Place the circuit on a clean towel to dry. Do not wipe dry. The circuit must be completely dry before storing.
6. Reassemble the circuit when dry. Store in a plastic bag or dust-free area.
7. Inspect components for deterioration prior to use.

### Cleaning the Reusable Exhalation Devices

Disassemble the exhalation device from the patient circuit. Follow the detailed cleaning instructions included with your exhalation device.

### Replacing the Bacteria Filter (Optional)

To remove a bacteria filter and replace it with a new one:

1. Disconnect the flexible tubing from the bacteria filter by gently pulling straight out from the filter. The proximal tubing (if using the Active PAP Exhalation Device) can remain connected to the ventilator.
2. Remove the used bacteria filter from the ventilator by gently pulling straight out from the connector. Follow the manufacturer's labeling and your institution's infection control guidelines for disposal of the bacteria filter.
3. Attach a new bacteria filter. The openings on either end of the bacteria filter are different sizes. Fit the larger opening onto the gas outlet port on the side of the ventilator as shown.



*Philips Respironics recommends that a main line outlet bacteria filter (Part Number 342077) be used whenever the device is used for invasive therapy or if the ventilator may be used on multiple patients.*

4. Connect the patient circuit. Fit the ventilator-end of the flexible tubing onto the bacteria filter.

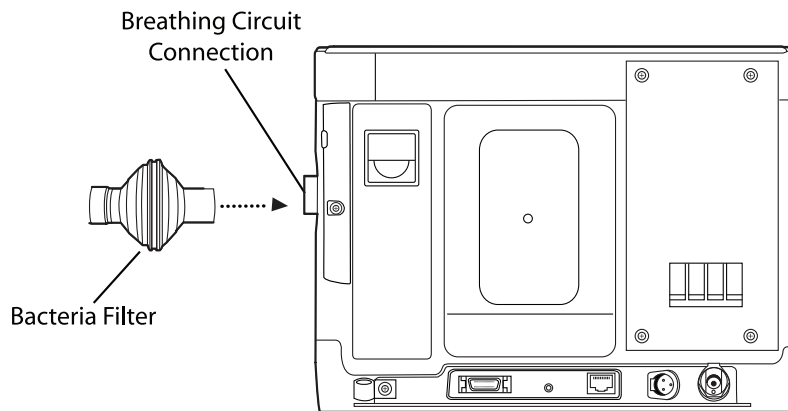

**Installing a New Bacteria Filter**

## Preventive Maintenance

Your new Philips Respironics Trilogy ventilator includes a PM Service Due label affixed to the bottom of your device. The label indicates when service is due. Service is due every 10,000 hours or 24 months, whichever comes first depending on the usage of the device.

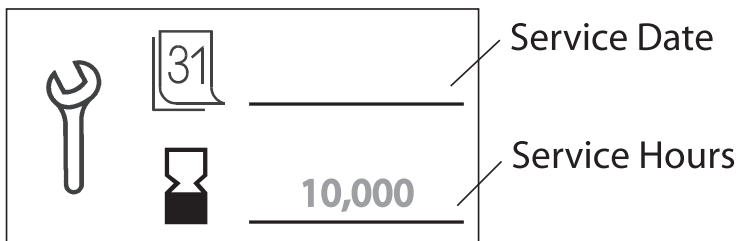

**Preventive Maintenance Label**

Ensure that both the date and hours are recorded on the label to maximize your in-service interval. Record the service date as 24 months from the date first placed on a patient. Record the hours as 10,000 hours for initial usage.

Use the device blower hours to determine when service is required. The device blower hours are listed in the device software in the information menu.

The following table provides information on recommended periodic maintenance for your device.

<b>Time / Hours of Service</b>	<b>Recommended Maintenance</b>
Prior to initial use on a patient	<ul style="list-style-type: none"> <li>• Charge Internal and Detachable Batteries to 100% capacity by plugging ventilator into an AC power source for up to 8 hours.</li> <li>• Perform System Checkout Procedure in Chapter 10.</li> </ul>
Prior to long term storage after initial use	<ul style="list-style-type: none"> <li>• Charge both Internal and Detachable batteries to 100% capacity prior to storage.</li> </ul>
While in storage after initial connection to AC Power, every 3 months	<ul style="list-style-type: none"> <li>• Recharge internal and detachable batteries to 100% capacity by plugging ventilator into an AC power source. Batteries should recharge in 8 hours or less.</li> </ul>
If in use, every two weeks	<ul style="list-style-type: none"> <li>• Inspect and clean air inlet filter.</li> </ul>
If in use, every 6 months	<ul style="list-style-type: none"> <li>• Replace air inlet filter.</li> <li>• Inspect enclosures and external connections for damage and contact Philips Respironics service if necessary.</li> <li>• Inspect power cord for damage and replace if necessary.</li> </ul>
Every 10,000 hours or 2 Years, whichever comes first	<ul style="list-style-type: none"> <li>• Perform performance verification test per Trilogy Service Manual by Philips Respironics trained service technician.</li> </ul>
Every 17,500 hours	<ul style="list-style-type: none"> <li>• Replace the Motor / Blower Assembly by Philips Respironics trained service technician.</li> <li>• Perform full calibration and verification by Philips Respironics trained service technician.</li> </ul>

Refer to the *Trilogy Service Manual* for additional information.





## 8. Troubleshooting

The ventilator is designed to respond to most issues with an appropriate alarm or information message. These messages appear on the display screen. Chapter 6 describes many of the alarms and what action you should take when the alarms occur.

This chapter provides troubleshooting information for some common issues you may encounter.

**Issue:** The device does not turn on.

**What to do:** Plug the AC power cord into the device and a wall outlet that is not controlled by a switch. This powers the system and charges the internal battery. If the device still does not turn on, contact an authorized service representative or Philips Respironics to have the device serviced. Please have the model number and serial number ready when you call.

**Issue:** The Low circuit leak alarm is sounding during nebulizer treatments.

**What to do:** Make sure the passive exhalation port is not blocked or missing. Refer to the nebulizer manufacturer's instructions to ensure the recommended flows are being used during the treatment. This alarm condition should resolve itself after the nebulizer treatment has been completed and removed from the circuit. However, if the low circuit leak alarm continues after the treatment has been removed from the circuit, contact your home care provider.

**Issue:** The batteries are not charging.

**What to do:** Assure AC Power LED is lit and that the device is plugged into AC power. Make sure the device is not close to a heat source. Ensure the cooling air vents are not blocked. Bring the ventilator to ambient room temperature. If the problem continues, contact an authorized service representative or Philips Respironics to have the device serviced. Please have the model number and serial number ready when you call.

**Issue:** There are unexplained changes in the performance of the device.

**What to do:** Press the Start/Stop button and then select the Right button to shut off the device for a few seconds. Restart the device by pressing the Start/Stop button. If the problem continues, relocate the device to an area with lower EMI emissions (e.g., away from electronic equipment such as cellular phones, cordless phones, computers, TVs, electronic games, hair dryers, etc.). Refer to Chapter 13. If the problem still occurs, contact an authorized service representative or Philips Respironics to have the device serviced. Please have the model number and serial number ready when you call.

**Issue:** The “Limit Reached” message appears when setting tidal volume or inspiratory time in volume modes.

**What to do:** In CV, AC, and SIMV modes the tidal volume setting is limited by the inspiratory time to maintain the system’s minimum and maximum peak flows. Call the patient’s healthcare professional.

**Issue:** A continuous alarm is sounding when the device is OFF.

**What to do:** To silence the alarm, press the Start/Stop key followed by the Right key. Make sure the batteries are fully charged and the device is plugged into AC power. If the device will not turn On after connected to AC power, contact an authorized service center or Philips Respironics to have the device serviced.

**Issue:** The apnea alarm is activated when the patient is in Assist Control mode.

**What to do:** The apnea alarm is only intended for spontaneously breathing patients. Controlled (machine triggered) breaths are not counted when the apnea alarm is enabled; therefore, if the patient is not breathing spontaneously the apnea alarm will be activated. Verify patient status and contact your healthcare professional.

**Issue:** There is excessive warm air coming out of the mask, much warmer than is normal.

**What to do:** Clean or replace the air filter as described in Chapter 7. The temperature of the air may vary based on the room temperature. Make sure the device is properly ventilated. Keep it away from bedding or curtains that could block the flow of air around the device. Make sure it is away from direct sunlight and heating equipment. Ensure the cooling air vents are not blocked. If the problem continues, contact an authorized service representative or Philips Respironics to have the device serviced. Please have the model number and serial number ready when you call.

**Issue:** The mask feels uncomfortable to wear, there is significant air leakage around the mask, or the patient experiences other mask-related issues.

**What to do:** Make sure the patient is properly fitted with the correct size mask. If the problem continues, try fitting the patient with a different mask.

**Issue:** The patient experiences nasal, sinus, or ear pain.

**What to do:** Tell the patient to stop using the device and contact their health care professional.

**Issue:** Patient Tubing Condensation - there is condensation in the circuit tubing or exhalation valve lines.

**What to do:** Use an appropriate method of water management, such as a water trap when using a heated humidifier.



## 9. Accessories

There are several accessories you can use with the ventilator.

Use only Philips Respironics approved accessories on Trilogy ventilators.

### Adding a Humidifier

Use of a humidifier may reduce nasal dryness and irritation by adding moisture to the airflow.

If you are using a humidifier with the ventilator, refer to the instructions provided with the humidifier for complete setup information.

### Adding Supplemental Oxygen to the Device

The delivered oxygen concentration varies with changes in flow in the circuit. The following may have an impact on oxygen concentration:

- Pressure settings
- Patient Tidal Volume
- Peak Inspiratory Flow
- I:E Ratio
- Respiratory rate
- Circuit leak rate
- Oxygen flow rate

To add oxygen to the circuit, the oxygen supply must comply with the local regulations for medical oxygen. The oxygen flow into the oxygen valve cannot exceed 15 l/min and the pressure cannot exceed 50 psi.

## Supplemental Oxygen Warnings

- When administering fixed-flow supplemental oxygen, the oxygen concentration may not be constant. The inspired oxygen concentration will vary, depending on the pressures, patient flows and circuit leak. Substantial leaks may reduce the inspired oxygen concentration to less than the expected value. Appropriate patient monitoring should be used, as medically indicated, such as an alarming pulse oximeter.
- This device DOES NOT alarm for loss of the low flow oxygen supply.
- Oxygen supports combustion. Oxygen should not be used while smoking or in the presence of an open flame.
- Do not connect the device to an unregulated or high pressure oxygen source.
- The device may result in incorrect flow and tidal volume measurements and improper operation of related alarms if you add low flow oxygen directly into the patient circuit or mask instead of directly adding it into the oxygen inlet on the back of the ventilator.
- If oxygen is used with the device, the oxygen flow must be turned off when the device is not in use. **Explanation of the Warning:** When the device is not in operation and the oxygen flow is left on, oxygen delivered into the tubing may accumulate within the device's enclosure.
- The ventilator should not be operated in the presence of flammable gasses. This could cause a fire or explosion.

## Using a Remote Alarm Unit

You can use a Philips Respironics Remote Alarm unit with your device. Use only a Philips Respironics dedicated adapter cable assembly for connecting the device to the Remote Alarm unit (REF 1045291). Refer to the instructions included with your Remote Alarm unit and adapter cable assembly if you have questions on how to use it with device.

### WARNING

*The remote alarm and nurse call systems should be tested daily. When using a remote alarm, make sure you fully test the remote alarm connector and cable by verifying that:*

- *Annunciated alarms on the ventilator are also annunciated on the remote alarm.*
- *Disconnecting the remote alarm cable from the ventilator or from the remote alarm results in an alarm notification at the remote alarm.*

## Using a Nurse Call System

You can use an institutional Nurse Call system with your device. Use only Philips Respironics cables available to connect a nurse call system to the device. Refer to the instructions included with your cable assembly if you have questions on how to connect it to the device.

Philips Respironics strongly recommends using a Normally Closed Nurse Call system. If a system with Normally Open logic is used, there are certain situations where the Nurse Call system can not indicate an alarm condition.

### WARNING

Ensure that the Nurse Call systems used do not exceed SELV (Safety Extra Low Voltage) levels as described in IEC 60601-1. SELV levels do not exceed a nominal value of 25VAC or 60VDC at rated supply voltage on the transformer or converter, between conductors in an earth-free circuit which is isolated from the supply mains by a safety extra low voltage transformer or by a device with equivalent separation.

### WARNING

The Trilogy's Nurse Call or Remote Alarm feature is for use only in a medically supervised environment.

### WARNING

Do not rely on the audible or visual indicator provided by the Nurse Call or Remote Alarm system as the primary indicator of the operating state of the device or of patient events.

### WARNING

The Nurse Call or Remote Alarm feature should be considered a back-up to the Trilogy device's primary alarm system. Do not rely solely on the Nurse Call or Remote Alarm feature.

## Using a Secure Digital (SD) Card

An SD card is provided with the device to record device usage information. You can insert the SD card into the SD Data Card slot on the left side of the device. Make sure the label on the SD card faces the back of the ventilator.

To insert the SD card:

1. Open the SD card door by sliding the door forward and then pulling it out, as shown below.

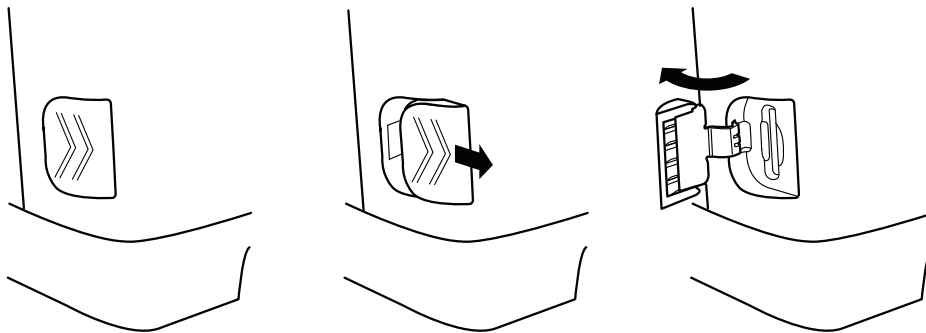

### Opening the SD Card Door



2. Push the SD card completely into the card slot until the card clicks into place.

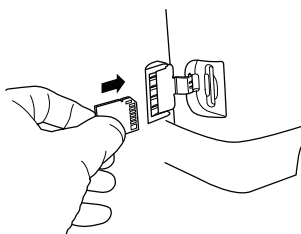

**Note:** The SD card does not need to be installed for the device to work properly.



### Inserting the SD Card

**Note:** Use only SD cards available from Philips Respironics.

To remove the SD card, select the “Safely Remove SD Card” option from the main menu. After the “Remove SD Card” confirmation message appears, remove the card by pushing the card in until the card clicks to release. The card will be slightly ejected from the device.

## Using the Philips Respironics DirectView Software

You can use the Philips Respironics DirectView 1.3 and above software to download the prescription data from the SD card to a computer. DirectView can be used by clinicians to receive and report stored data from the SD card. DirectView does not perform any automatic scoring or diagnosing of a patient’s therapy data.

**Note:** Remote prescription changes are not permitted.

## Using the Optional In-Use Bag

An optional, in-use bag is available for use with the ventilator. The in-use bag is required for portable use in order to properly secure the ventilator. See the instructions included with the in-use bag for details on how to use the bag with your device.

## Connect a Water Trap

If you are using an optional water trap, connect it to the patient circuit according to the manufacturer’s instructions.

## Using an Oximetry Module (When Available)

There is a dedicated oximetry interface kit for connecting the Trilogy device to an oximetry module. Refer to the instructions included with the oximetry interface kit if you have questions on how to connect it to your device.

## Traveling with the System

When traveling, the carrying case is for carry-on luggage only. The carrying case will not protect the system if it is put through checked baggage.

For your convenience at security stations, there is a note on the bottom of the device stating that it is medical equipment and is suitable for airline use. It may be helpful to bring this manual along with you to help security personnel understand the device.

If you are traveling to a country with a line voltage different than the one you are currently using, a different power cord or an international plug adaptor may be required to make your power cord compatible with the power outlets of the country to which you are traveling.

## Airline Travel

The device is suitable for use on airlines when the device is operating from an internal, detachable, or external battery power source. It is not suitable for airline use when operating from AC power or from DC power sourced from the airplane.

**Note:** The device is not suitable for airline use with any humidifiers or modems installed in the unit.



# 10. System Checkout Procedures

This chapter details the test procedures that should be performed by the clinician prior to connecting the device to the patient. Test both the active and passive circuits if you want to do a complete checkout on the device. The tests should be performed as described in order to verify proper operation of the device. Some of the procedures in this chapter require you to change settings on the device. If you are not familiar with the procedures for accomplishing this, please refer to Chapter 4, *Ventilator Setup* and Chapter 5, *Viewing and Changing Settings*.

**Note:** *The actual circuit configuration to be used on the patient should be used to perform the system checkout procedure.*

## Tools Required

- Active Exhalation Porting Block with PAP
- Passive Exhalation Porting Block
- Active PAP Exhalation Device
- Passive Exhalation Device
- Test Lung
- Small Flat Head Screwdriver

## Visual Inspection

1. Verify that the enclosure is not broken and that all applicable screws are in place.
2. Verify that the device handle, SD Card door, and detachable battery are secure and in good working order.

### **WARNING**

*If you notice any unexplained changes in the performance of the device, if it is making unusual sounds, if the device or detachable battery are dropped, if water is spilled into the enclosure, or if the enclosure is cracked or broken, discontinue use and contact Philips Respironics or an authorized service center for service.*

3. Verify that the rubber feet are on the bottom of the device.

## Initial Setup

1. Connect the power cord to the device and then to an AC outlet.
2. Attach the test lung to the patient connection end of the desired circuit (Active PAP or Passive).
3. Follow the instructions in Chapter 5 to access the Setup Screen.

## Settings and Alarms Tests

Complete the following steps to set up the settings and alarms tests.

### 1. Setup

#### A. Settings And Alarms Menu

Modify the settings in the Settings and Alarms menu to match those shown below in Table 1. If necessary, refer to Chapter 5 for instructions on modifying ventilator settings.

Setting	Value
Dual Prescription	Off
Circuit Type	Active PAP or Passive
Therapy Mode	S/T
AVAPS (passive circuit only)	Off
IPAP	20 cm H <sub>2</sub> O
EPAP	4 cm H <sub>2</sub> O
Breath Rate	12 BPM
Inspiratory Time	1.6 seconds
Trigger Type (passive circuit)	Auto-Trak
Flow Trigger Sensitivity (active PAP circuit)	6.0 l/min
Flow Cycle Sensitivity (active PAP circuit)	20%



**Table 1 - Ventilator Settings in the Settings and Alarms Menu**

Setting	Value
Rise Time	1
Ramp Length	Off
All other alarms	Off

## B. Options Menu

Modify the settings in the Options menu to match those shown below in Table 2.

Setting	Value
Menu Access	Full
Detailed View	On
All other settings	Discretionary



**Table 2 - Ventilator Settings in the Options Menu**

## C. Turn Device Power On

Press the Start/Stop button on the front of the ventilator. The system will begin operating using the defined ventilation settings.

## 2. Verify the High Tidal Volume Alarm

This procedure verifies that the High Tidal Volume alarm is working properly. For passive circuits, this will verify the High Vte alarm. For active with PAP circuits, this will verify the High Vti alarm. It assumes that you have attached the test lung, verified the ventilator settings, and turned on ventilator power as described in the Initial Setup section.

### A. Change Alarm Ventilator Setting

Modify the High Tidal Volume alarm setting to match the one shown below in Table 3.

Setting	Value
High Vte/High Vti	50 ml



**Table 3 - High Vte/High Vti Alarm Setting**

## B. Verify the Alarm

Wait up to 40 seconds and verify the following alarm signals:

- The High Priority audible indicator sounds
- A red light flashes on the Alarm Indicator/Audio Pause button
- The High Tidal Volume alarm condition appears on the screen, highlighted in red

## C. Modify Ventilator Alarm Settings

Modify the High Tidal Volume alarm setting to match the one shown below in Table 4.

Setting	Value
High Vte/High Vti	500 ml



**Table 4 - Modify High Vte/High Vti Alarm Setting**

## D. Verify Reset

Wait 40 seconds and verify the following auto-reset conditions:

- The High Priority audible indicator has stopped sounding
- The red light on the Alarm Indicator/Audio Pause button has stopped flashing

## E. Restore Ventilator Settings

Modify the ventilator settings and change the following value shown in Table 5.

Setting	Value
High Vte/High Vti	Off



**Table 5 - Restore Ventilator Settings**

## 3. Verify the Low Tidal Volume Alarm

This procedure verifies that the Low Tidal Volume alarm is working properly. For passive circuits, this will verify the Low Vte alarm. For active with PAP circuits, this will verify the Low Vti alarm. It assumes that you have attached the test lung, verified the ventilator settings, and turned on ventilator power as described in the Initial Setup section.

**Note:** Do not use the “Reset” button to manually reset the alarm. Instead, use the “Modify” button to change ventilator settings. This applies to all tests.

A. Change Alarm Ventilator Setting

Modify the Low Tidal Volume alarm setting to match the one shown below in Table 6.

Setting	Value
Low Vte/Low Vti	500 ml



**Table 6 - Low Vte/Low Vti Alarm Setting**

B. Verify the Alarm

Wait up to 40 seconds and verify the following alarm signals:

- The High Priority audible indicator sounds
- A red light flashes on the Alarm Indicator/Audio Pause button
- The Low Tidal Volume alarm condition appears on the screen, highlighted in red

C. Modify Ventilator Alarm Settings

Modify the Low Tidal Volume alarm setting to match the one shown below in Table 7.

Setting	Value
Low Vte/Low Vti	50 ml



**Table 7 - Modify Low Vte/Low Vti Alarm Setting**

D. Verify Reset

Wait 40 seconds and verify the following auto-reset conditions:

- The High Priority audible indicator has stopped sounding
- The red light on the Alarm Indicator/Audio Pause button has stopped flashing

E. Restore Ventilator Settings

Modify the ventilator settings and change the following value shown in Table 8.

Setting	Value
Low Vte/Low Vti	Off



**Table 8 - Restore Ventilator Settings**



#### 4. Verify Circuit Disconnect Alarm

This procedure verifies that the Circuit Disconnect alarm is working properly. It assumes that you have attached the test lung, verified ventilator settings, and turned on ventilator power as described in the Initial Setup section.

##### A. Change Circuit Disconnect Ventilator Setting

Modify the Circuit Disconnect ventilator setting to match the value shown below in Table 9.

Setting	Value
Circuit Disconnect	10 seconds



**Table 9 - Ventilator Settings**

**Note:** The Low Inspiratory or Low Expiratory Pressure Alarm may also be detected.

##### B. Disconnect Test Lung

Disconnect the test lung from the circuit.

##### C. Verify the Alarm

Wait approximately 10 seconds and verify the following alarm signals:

- The High Priority Audible Indicator sounds
- A red light flashes on the Alarm Indicator/Audio Pause button
- The Circuit Disconnect alarm condition appears on the screen, highlighted in red

##### D. Reconnect Test Lung

Reconnect the test lung to the circuit.

##### E. Verify Reset

Wait at least 40 seconds and verify the following auto-reset conditions:

- The High Priority audible indicator has stopped sounding
- The red light on the Alarm Indicator/Audio Pause button has stopped flashing

## F. Restore Ventilator Settings

Modify the ventilator settings and change the following values shown below in Table 10.

Setting	Value
Circuit Disconnect	Off



**Table 10 - Restore Ventilator Settings**

## 5. Verify the High Inspiratory Pressure Alarm

This procedure verifies that the High Inspiratory Pressure alarm is working properly. It assumes that you have attached the test lung, verified ventilator settings, and turned on ventilator power as described in the Initial Setup section.

### A. Change Ventilator Settings

Modify the ventilator settings and change the following values shown below in Table 11.

Setting	Value
Mode	CV
Tidal Volume	500 ml
Breath Rate	12 BPM
Inspiratory Time	1.0 seconds
Flow Pattern	Ramp
PEEP	4 cm H <sub>2</sub> O
Sigh	Off
Circuit Disconnect	Off
Low Inspiratory Pressure	6 cm H <sub>2</sub> O
High Inspiratory Pressure	10 cm H <sub>2</sub> O
Apnea	Off
All other alarms	Off



**Table 11 - Ventilator Settings**

**Note:** If this alarm is not reset within 3 occurrences, the alarm is elevated to High Priority, and the High Priority Indicators occur.

## B. Verify the Alarm

Wait up to 40 seconds and verify the following alarm signals:

- The Medium Priority audible indicator sounds
- A yellow light flashes on the Alarm Indicator/Audio Pause button
- The High Inspiratory Pressure alarm condition appears on the screen, highlighted in yellow

## C. Modify Ventilator Alarm Settings

Modify the High Inspiratory Pressure setting to match the one shown below in Table 12.

Setting	Value
High Inspiratory Pressure	60 cm H <sub>2</sub> O



**Table 12 - Modify High Inspiratory Pressure Alarm Setting**

## D. Verify Reset

Wait 40 seconds and verify the following auto-reset conditions:

- The Medium Priority audible indicator has stopped sounding
- The yellow light on the Alarm Indicator/Audio Pause button has stopped flashing

## 6. Verify the Low Inspiratory Pressure Alarm

This procedure verifies that the Low Inspiratory Pressure alarm is working properly. It assumes that you have attached the test lung, verified ventilator settings, and turned on ventilator power as described in the Initial Setup section.

### A. Change Ventilator Settings

Modify the ventilator settings and change the following values shown below in Table 13.

Setting	Value
Mode	CV
Tidal Volume	500 ml
Breath Rate	12 BPM
Inspiratory Time	1.0 seconds



**Table 13 - Ventilator Settings**

Setting	Value
Flow Pattern	Ramp
PEEP	4 cm H <sub>2</sub> O
Sigh	Off
Circuit Disconnect	Off
Low Inspiratory Pressure	40 cm H <sub>2</sub> O
High Inspiratory Pressure	60 cm H <sub>2</sub> O
Apnea	Off
All other alarms	Off

B. Verify the Alarm

Wait up to 40 seconds and verify the following alarm signals:

- The High Priority audible indicator sounds
- A red light flashes on the Alarm Indicator/Audio Pause button
- The Low Inspiratory Pressure alarm condition appears on the screen, highlighted in red

C. Modify Ventilator Alarm Settings

Modify the Low Inspiratory Pressure setting to match the one shown below in Table 14.

Setting	Value
Low Inspiratory Pressure	6 cm H <sub>2</sub> O



**Table 14 - Modify Low Inspiratory Pressure Alarm Setting**

D. Verify Reset

Wait 40 seconds and verify the following auto-reset conditions:

- The High Priority audible indicator has stopped sounding
- The red light on the Alarm Indicator/Audio Pause button has stopped flashing

## Battery Function Verification

Make sure the batteries are functioning properly and fully charged before patient use.

### 1. Verify the Detachable and Internal (Lithium-Ion)

#### Batteries Function

- A. Connect AC Power to the device and verify that the green AC LED on the front panel is lit.
- B. Verify that the detachable battery is properly installed.
- C. Turn the device on and verify that both the detachable and internal battery symbols appear on the display. Verify that if either battery is less than fully charged, the charge symbol will display on the respective battery.
- D. Disconnect the AC Power source from the device.
  - Verify that the AC Power Disconnected alarm message appears on the display and the green AC LED is not lit. Press Reset.
  - Verify that the detachable battery symbol shows the level of charge noted in the previous step and that the device continues to operate.
  - Verify that the detachable battery symbol has a black box around it to indicate that it is in use.
- E. Disconnect the detachable battery pack from the device.
  - Verify that the Detach Batt Disconnected alarm message appears on the display. Press Reset.
  - Verify that the internal battery symbol shows the same level of charge as noted in Step C and the device continues to operate.
  - Verify that the internal battery symbol has a black box around it to indicate that it is in use.
- F. Reconnect the Detachable Battery and AC Power source.

## 2. Verify the External Battery Function (Optional)

- A. Connect AC Power to the device and verify that the green AC LED is lit.
- B. Connect the external battery cable to the external battery and to the ventilator.
- C. Verify that the external battery symbol is shown on the display and some level of charge is present.
- D. Disconnect the AC Power source from the device.
  - Verify that the AC Power Disconnected alarm message appears on the display and the green AC LED is not lit. Press Reset.
  - Verify that the external battery symbol shows the level of charge as noted in the previous step and the device continues to operate.
  - Verify that the external battery symbol has a black box around it to indicate that it is in use.
- E. Reconnect the AC Power source.

## Alarm and Event Log Clean-Up

1. In the Setup Menu, select **Alarm Log**.
  - A. Press **Clear** to clear the log file.
  - B. Press **Yes** to confirm.
  - C. Press **Finish** to complete.
2. In the Setup Menu, select **Event Log**.
  - A. Press **Clear** to clear the log file.
  - B. Press **Yes** to confirm.
  - C. Press **Finish** to complete.

## Results

All portions of this checkout procedure should be completed prior to connection to the patient. If any of the tests fail to complete as indicated, if possible, correct the error, clear the alarm and resume testing. If correction of the failed portion is not possible, return the device to Philips Respironics or an authorized service center for service and repair.

# 11. Technical Specifications

## Environmental

	Operating	Storage
<b>Temperature</b>	41° F to 104° F (5° C to 40° C)	-4° F to 140° F (-20° C to 60° C)
<b>Relative Humidity</b>	15 to 95% (non-condensing)	15 to 95% (non-condensing)
<b>Atmospheric Pressure</b>	110 kPa to 60 kPa	N/A

The operating range for the charging of the internal and detachable batteries is 10° C to 30° C. The internal and detachable batteries will power the ventilator for the full operating range of 5° C to 40° C.

Accuracies stated in this manual are based on specific environmental conditions. For stated accuracy, the environmental conditions are: Temperature: 20-30° C; Humidity: 50% relative; Altitude: nominally 380 meters

## Physical

Dimensions: 6.6" L x 11.2" W x 9.3" H (16.68 cm L x 28.45 cm W x 23.52 cm H)

Weight: Approximately 11 lbs. (5 kg) with the detachable battery installed

## Standards Compliance

This device is designed to conform to the following standards:

- IEC 60601-1: Medical electrical equipment - Part 1: General requirements for safety
- IEC 60601-1-2: General requirements for safety - Collateral standard: Electromagnetic compatibility - Requirements and tests
- ISO 10651-2-Lung ventilators for medical use -- Particular requirements for basic safety and essential performance -- Part 2: Home care ventilators for ventilator-dependent patients
- RTCA-D0160F section 21, category M; Emission of Radio Frequency Energy



## Electrical

AC Voltage Source:	100 to 240 VAC, 50/60 Hz, 2.1 A
Detachable Battery:	Voltage: 14.4 VDC Capacity: 4176 mAh Chemistry type: Lithium-Ion
Internal Battery:	Voltage: 14.4 VDC Capacity: 4176 mAh Chemistry type: Lithium-Ion
Type of Protection Against Electric Shock:	Class II/Internally Powered Equipment
Degree of Protection Against Electric Shock:	Type BF Applied Part
Degree of Protection against Ingress of Water:	Device: Drip Proof, IPX1
Mode of Operation:	Continuous
Fuses:	There are no user-replaceable fuses.

## Pressure

Output:	4 to 50 cm H <sub>2</sub> O
---------	-----------------------------

## SD Card and SD Card Reader

Use only SD cards and SD card readers available from Philips Respironics or the following:

Use only Philips Respironics approved SD cards 1 GB or greater

SanDisk® Card Reader/Writer - SanDisk ImageMate - REF SDDR-99-A15

## Control Accuracy

Parameter	Range	Accuracy
IPAP	4 to 50 <sup>1</sup> cm H <sub>2</sub> O <sup>2</sup>	Greater of 2 cm H <sub>2</sub> O or 8% of setting
EPAP	0 to 25 cm H <sub>2</sub> O for Active Circuits 4 to 25 cm H <sub>2</sub> O for Passive Circuits	Greater of 2 cm H <sub>2</sub> O or 8% of setting
CPAP	4 to 20 cm H <sub>2</sub> O	Greater of 2 cm H <sub>2</sub> O or 8% of setting
PEEP	0 to 25 cm H <sub>2</sub> O for Active Circuits 4 to 25 cm H <sub>2</sub> O for Passive Circuits	Greater of 2 cm H <sub>2</sub> O or 8% of setting <sup>4</sup>
Pressure	4 to 50 cm H <sub>2</sub> O	Greater of 2 cm H <sub>2</sub> O or 8% of setting
Pressure Support	0 to 30 cm H <sub>2</sub> O <sup>3</sup>	Greater of 2 cm H <sub>2</sub> O or 8% of setting <sup>4</sup>
Tidal Volume	50 to 2000 ml <sup>5</sup>	Greater of 15ml or 10% of setting (Active Circuits) Greater of 15ml or 15% of setting (Passive Circuits)
Breath Rate	0 to 60 BPM for AC mode 1 to 60 BPM for all other modes	Greater of ± 1 BPM or ±10% of the setting
Timed Inspiration	0.3 to 5.0 seconds	± .1 second
Rise Time	1 to 6 <sup>6</sup>	±2 cm H <sub>2</sub> O (the device will increase to a pressure <sup>7</sup> of .67* (IPAP - EPAP) ±2 cm H <sub>2</sub> O @ the set rise time multiplied by 100 ms for pressure supports less than or equal to 25.)
Ramp Start Pressure	0 to 25 cm H <sub>2</sub> O for Active Circuits 4 to 25 cm H <sub>2</sub> O for Passive Circuits 4 to 19 cm H <sub>2</sub> O in CPAP mode	8% of setting + 2% Full Scale
Ramp Length	Off, 5 to 45 minutes	±2 minutes
Flex	Off, 1 to 3 <sup>7</sup>	N/A
Flow Trigger Sensitivity	1 to 9 l/min	N/A
Flow Cycle	10 to 90%	N/A
Apnea Rate	4 to 60 BPM <sup>8</sup>	Greater of 1 BPM or 10% of setting

Specifications listed are based on using a standard circuit (1.8 meter tubing- REF 622038 ; Whisper Swivel II - REF 332113; Active PAP Exhalation Device - REF 1053716; Active Exhalation Device – REF 1065658)

<sup>1</sup>Limited to 25 cm H<sub>2</sub>O when using the Bi-Flex feature in S mode.

<sup>2</sup>Pressure units may be cm H<sub>2</sub>O, hPa, or mBar depending on device setup.

<sup>3</sup>The difference between the Inspiratory Pressure and the Expiratory Pressure must never be more than 30 cm H<sub>2</sub>O.

<sup>4</sup>Pressure Support and PEEP not to exceed 50 cm H<sub>2</sub>O.

<sup>5</sup>All flows and volumes are measured at BTPS conditions.

<sup>6</sup>The range of values correspond to tenths of seconds (e.g., a setting of 4 indicates a Rise Time of 0.4 seconds).

<sup>7</sup>Flex is not available when AVAPS is active. Flex is not available with Active Circuits.

<sup>8</sup>Apnea Rate setting is not available in T mode or CV mode.

## Measured Patient Parameters

Parameter	Range	Accuracy
Vte/Vti	0 to 2000 ml	Greater of 15ml or 15% of reading
Minute Ventilation	0 to 99 l/min	Calculation based on measured Vte or Vti and Respiratory Rate
Estimated Leak Rate	0 to 200 l/min	N/A
Respiratory Rate	0 to 80 BPM	Greater of 1 BPM or 10% of reading
Peak Inspiratory Flow	0 to 200 l/min	3 l/min plus 15% of reading
Peak Inspiratory Pressure	0 to 99 cm H <sub>2</sub> O	Greater of 2 cm H <sub>2</sub> O or 10% of reading
Mean Airway Pressure	0 to 99 cm H <sub>2</sub> O	Greater of 2 cm H <sub>2</sub> O or 10% of reading
% Patient Triggered Breaths	0 to 100%	N/A
I:E Ratio	9.9- 1: 1-9.9	Calculation based on Inspiratory Time and Expiratory Time

All flows and volumes are measured at BTPS conditions.

## Spontaneous Breathing During Power Failure Conditions

Flow Set Point (l/min)	Inspiratory Resistance (cm H <sub>2</sub> O)		Expiratory Resistance (cm H <sub>2</sub> O)	
	Active Circuit	Passive Circuit	Active Circuit	Passive Circuit
30	< 2.0	< 1.0	< 1.5	< 1.2
60	< 10.0	< 4.0	< 4.0	< 3.7

## Disposal

Dispose of the device and batteries in accordance with local regulations.

## 12. Glossary

The following terms and acronyms appear throughout this manual.

<b>Term/Acronym</b>	<b>Definition</b>
AC Power	Alternating Current power
AC	Assist Control therapy mode; AC mode delivers Assisted and Mandatory breaths with a user-defined inspired tidal volume. This is a Volume Control mode.
Apnea	A condition marked by the temporary cessation of spontaneous breathing.
Assisted Breath	Breath type in which the breath is patient-triggered and the ventilator controls how the air is delivered based on defined settings. An assisted breath is not cycled until the inspiratory time setting has been reached.
AVAPS	Average Volume Assured Pressure Support feature (available in S, S/T, T, and PC therapy modes).
Blower Hours	The total number of hours that the blower has been on over the life of the device. This value helps determine when the ventilator needs to be serviced. You cannot reset this value. It can only be reset by an authorized service center.
BPM	Breaths Per Minute

Term/Acronym	Definition
BTPS	Body Temperature and Pressure Saturated; A standardization for lung volumes and flows to barometric pressure at sea level, body temperature, and saturated with water vapor reflecting the condition of air in the lung.
CPAP	Continuous Positive Airway Pressure
CV	Control Ventilation therapy mode; CV mode delivers Mandatory breaths with a user-defined inspired tidal volume. This is a Volume Control mode.
DC	Direct Current
EPAP	Expiratory Positive Airway Pressure
ESD	Electrostatic Discharge
Flex	The device provides the Flex comfort feature. The C-Flex™ feature provides increased pressure relief during the expiratory phase of breathing. The Bi-Flex® feature provides a level of pressure relief taking place at the end of inhalation and at the start of exhalation.
I:E Ratio	The ratio of inspiratory time to expiratory time.
IPAP	Inspiratory Positive Airway Pressure
LED	Light Emitting Diode
l/min	Liters Per Minute

Term/Acronym	Definition
Mandatory Breath	A Mandatory Breath is completely controlled by the ventilator. Breaths are initiated by the ventilator according to the breath Rate (BPM) setting. Breaths are cycled according to the Inspiratory time setting.
MAP	Mean Airway Pressure. This is the average airway pressure over a full breath cycle. The MAP value displayed on the screen represents the average MAP value over six breaths and is updated at the end of each exhalation.
Minute Ventilation	The volume of gas that moves in and out of the lungs in one minute. It is calculated by multiplying the tidal volume by the respiratory rate. The Minute Ventilation value displayed on the screen represents the average Minute Ventilation over six breaths and is updated at the end of each exhalation.
Operational Hours	This is the total number of hours that the blower has been on since this value was last reset. You can reset this value each time you give the device to a new patient to help track their device usage.
OSA	Obstructive Sleep Apnea
PC	Pressure Control therapy mode; PC mode delivers Assisted and Mandatory breaths with a user-defined pressure. This is a Pressure Control mode.
PC SIMV	Pressure Control Synchronous Intermittent Mandatory Ventilation therapy mode; PC-SIMV mode delivers Spontaneous, Assisted, and Mandatory breaths. This is a Pressure Control mode.
Peak Flow	Maximum flow rate (in liters per minute) reached during a breath.
Peak Inspiratory Pressure (PIP)	Highest pressure reached during inspiration.

Term/Acronym	Definition
PEEP	Positive End Expiratory Pressure
Pressure Control Ventilation (PCV)	Ventilation in which breaths are controlled by operator-defined Pressure, Inspiratory Time, and Rise Time.
PS	Pressure Support
Ramp	A feature that may increase patient comfort when therapy is started. The ramp feature reduces pressure and then gradually increases the pressure to the prescription setting so patients can fall asleep more comfortably.
Rise Time	The Rise Time is the time it takes the ventilator to change from expiration to inspiration.
RR	Respiratory Rate (the number of breaths per minute).
SD Card	Secure Digital card; This card records usage and therapy data from the device.
Sigh	A breath that is delivered every 100 mandatory or assisted breaths at 150% of the normal volume.
SIMV	Synchronous Intermittent Mandatory Ventilation therapy mode; SIMV mode delivers Spontaneous, Assisted, and Mandatory breaths with a user-defined inspired tidal volume. This is a Volume Control mode.
Sleep State	A low-power state entered when the ventilator is running on the internal or detachable battery and the blower has been off for five minutes. This state preserves battery power. The device is restored by plugging the unit into AC power, inserting an SD card, or by pressing the Start/Stop button.
Spontaneous Breath	Breath type in which the breath is patient-triggered.

Term/Acronym	Definition
Spontaneous (S) Mode	Therapy mode in which all breaths are spontaneous. The ventilator supports breathing with user-defined Pressure Support (PS) and Rise Time values.
Spontaneous/Timed (S/T) Mode	Therapy mode that is similar to S mode, except that it can also deliver a mandatory breath if the patient does not spontaneously breathe within a set time.
Tidal Volume	The amount of air passing in and out of the lungs for each breath.
Timed (T) Mode	Timed pressure support therapy mode. In Timed mode, all breaths delivered are mandatory.
Volume Control Ventilation (VCV)	Ventilation in which breaths are controlled by an operator-defined volume, flow pattern, breath rate, and inspiratory time.
Vte	Exhaled Tidal Volume
Vti	Inhaled Tidal Volume





# 13. EMC Information

## Guidance and Manufacturer's Declaration - Electromagnetic Emissions

This device is intended for use in the electromagnetic environment specified below. The user of this device should make sure it is used in such an environment.

<b>Emissions Test</b>	<b>Compliance</b>	<b>Electromagnetic Environment - Guidance</b>
RF emissions CISPR 11	Group 1	The device uses RF energy only for its internal function. Therefore, its RF emissions are very low and are not likely to cause any interference in nearby electronic equipment.
RF emissions CISPR 11	Class B	The device is suitable for use in all establishments, including domestic establishments and those directly connected to the public low-voltage power supply network that supplies building used for domestic purpose.
Harmonic emissions IEC 61000-3-2	Class A	
Voltage fluctuations/Flicker emissions IEC 61000-3-3	Complies	

## Guidance and Manufacturer's Declaration - Electromagnetic Immunity

This device is intended for use in the electromagnetic environment specified below. The user of this device should make sure it is used in such an environment.

Immunity Test	IEC 60601 Test Level	Compliance Level	Electromagnetic Environment - Guidance
Electrostatic Discharge (ESD) IEC 61000-4-2	±6 kV contact ±8 kV air	±8 kV contact ±15 kV air	Floors should be wood, concrete or ceramic tile. If floors are covered with synthetic material, the relative humidity should be at least 30%.
Electrical fast Transient/burst IEC 61000-4-4	±2 kV for power supply lines ±1 kV for input-output lines	±2 kV for supply mains ±1 kV for input/output lines	Mains power quality should be that of a typical home or hospital environment.
Surge IEC 61000-4-5	±1 kV differential mode ±2 kV common mode	±1 kV differential mode ±2 kV for common mode	Mains power quality should be that of a typical home or hospital environment.
Voltage dips, short interruptions and voltage variations on power supply input lines IEC 61000-4-11	<5% $U_T$ (>95% dip in $U_T$ ) for 0.5 cycle 40% $U_T$ (60% dip in $U_T$ ) for 5 cycles 70% $U_T$ (30% dip in $U_T$ ) for 25 cycles <5% $U_T$ (>95% dip in $U_T$ ) for 5 sec	<5% $U_T$ (>95% dip in $U_T$ ) for 0.5 cycle 40% $U_T$ (60% dip in $U_T$ ) for 5 cycles 70% $U_T$ (30% dip in $U_T$ ) for 25 cycles <5% $U_T$ (>95% dip in $U_T$ ) for 5 sec	Mains power quality should be that of a typical home or hospital environment. If the user of the device requires continued operation during power mains interruptions, it is recommended that the device be powered from an uninterruptible power supply or a battery.
Power frequency (50/60 Hz) magnetic field IEC 61000-4-8	3 A/m	3 A/m	Power frequency magnetic fields should be at levels characteristic of a typical home or hospital environment.
NOTE: $U_T$ is the a.c. mains voltage prior to application of the test level.			

## Guidance and Manufacturer's Declaration - Electromagnetic Immunity

This device is intended for use in the electromagnetic environment specified below. The user of this device should make sure it is used in such an environment.

Immunity Test	IEC 60601 Test Level	Compliance Level	Electromagnetic Environment - Guidance
Conducted RF IEC 61000-4-6	3 Vrms 150 kHz to 80 MHz outside ISM bands <sup>a</sup>	3 V	Portable and mobile RF communications equipment should be used no closer to any part of the device, including cables, than the recommended separation distance calculated from the equation applicable to the frequency of the transmitter. Recommended separation distance: $d = 1.2 \sqrt{P}$
	10Vrms 150 kHz to 80 MHz in ISM bands <sup>a</sup>	10 V	
Radiated RF IEC 61000-4-3	10 V/m 80 MHz to 2.5 GHz	10 V/m 26 MHz to 2.5 GHz	$d = 1.2 \sqrt{\frac{P}{f}}$ 80 MHz to 800 MHz $d = 2.3 \sqrt{\frac{P}{f}}$ 800 MHz to 2.5 GHz  where $P$ is the maximum output power rating of the transmitter in watts (W) according to the transmitter manufacturer and $d$ is the recommended separation distance in meters (m).  Field strengths from fixed RF transmitters, as determined by an electromagnetic site survey <sup>a</sup> , should be less than the compliance level in each frequency range. <sup>b</sup>  Interference may occur in the vicinity of equipment marked with the following symbol: 
NOTE 1 At 80 MHz and 800 MHz, the higher frequency range applies. NOTE 2 These guidelines may not apply in all situations. Electromagnetic propagation is affected by absorption and reflection from structures, objects, and people. a Field strengths from fixed transmitters, such as base stations for radio (cellular/cordless) telephones and land mobile radios, amateur radio, AM and FM radio broadcast and TV broadcast cannot be predicted theoretically with accuracy. To assess the electromagnetic environment due to fixed RF transmitters, an electromagnetic site survey should be considered. If the measured field strength in the location in which the device is used exceeds the applicable RF compliance level above, the device should be observed to verify normal operation. If abnormal performance is observed, additional measures may be necessary, such as re-orienting or relocating the device. b Over the frequency range 150 kHz to 80 MHz, the field strengths should be less than 3 V/m.			

## Recommended Separation Distances between Portable and Mobile RF Communications Equipment and This Device

The device is intended for use in an electromagnetic environment in which radiated RF disturbances are controlled. The customer or the user of this device can help prevent electromagnetic interference by maintaining a minimum distance between portable and mobile RF communications equipment (transmitters) and this device as recommended below, according to the maximum output power of the communications equipment.

Rated Maximum Power Output of Transmitter (Watts)	Separation Distance According to Frequency of Transmitter (meters)			
	150 kHz to 80 MHz outside ISM Bands $d = 1.2\sqrt{P}$	150 kHz to 80 MHz in ISM Bands $d = 1.2\sqrt{P}$	80 MHz to 800 MHz $d = 1.2\sqrt{P}$	800 MHz to 2.5 GHz $d = 2.3\sqrt{P}$
0.01	0.12	0.12	0.12	0.23
0.1	0.38	0.38	0.38	0.73
1	1.2	1.2	1.2	2.3
10	3.8	3.8	3.8	7.3
100	12	12	12	23

For transmitters rated at a maximum output power not listed above, the recommended separation distance  $d$  in meters (m) can be estimated using the equation applicable to the frequency of the transmitter, where  $P$  is the maximum output power of the transmitter manufacturer.

Note 1: At 80 MHz and 800 MHz, the higher frequency range applies.

Note 2: The ISM (industrial, scientific and medical) bands between 150 kHz and 80 MHz are 6.765 MHz to 6.795 MHz; 13.553 MHz to 13.567 MHz; 26.957 MHz to 27.283 MHz; and 40.66 MHz to 40.70 MHz.

Note 3: An additional factor of 10/3 is used in calculating the recommended separation distance for transmitters in the ISM frequency bands between 150 kHz and 80 MHz and in the frequency range of 80 MHz and 2.5 GHz to decrease the likelihood that mobile/portable communications equipment could cause interference if it is inadvertently brought into patient areas.

Note 4: These guidelines may not apply in all situations. Electromagnetic propagation is affected by absorption and reflection from structures, objects and people.

# Index

## A

AC Power 47  
AC Power Inlet 17  
Active Exhalation Device 54  
Air Filter  
    Installation 46  
Air Inlet 18  
Air Inlet Filter  
    Cleaning 116  
    Replacing 117  
Air Inlet Path  
    Replacing 117  
Alarm and Event Log Clean-Up 143  
Alarm Log 82  
Alarms 93  
    Alarm Indicators 94  
    Alarm Messages 96  
    Alarm Reset 99  
    Alarm Volume Control 100  
Patient Alarms  
    High Exhaled Tidal Volume 39  
    High Minute Ventilation 41  
    Low Exhaled Tidal Volume 39, 40  
    Low Minute Ventilation 41  
    Low Peak Inspiratory Pressure 40  
    Low Respiratory Rate 40

Power Alarms 101  
    External Battery Disconnected 44  
System Alarms  
    High Expiratory Pressure 38  
    Low Circuit Leak 38  
    Low Expiratory Pressure 38  
    Ventilator Service Required 37  
Alarm Volume Setting 80  
Apnea Setting 72  
Assist Control Mode 28, 79  
Audio Pause 99  
AVAPS Feature 32

## B

Bacteria Filter  
    Replacing 119  
Battery Function Verification 142  
Breathing Circuit  
    Connection 53  
Breathing Circuit Connection 17  
Breath Rate 77, 78  
Breath Types  
    Assist 20  
    Mandatory 20  
    Sigh 20  
    Spontaneous 20

**C**

Cautions 8, 15, 129  
Circuit Type Setting 70  
Contraindications 11  
Control Ventilation Mode 27, 78  
Cord Retainer 18  
CPAP Mode 22

**D**

Date Format 81  
DC Power  
    Detachable Battery Pack 48  
    External Battery 48  
Detachable Battery Pack 18  
Detailed View 79  
DirectView Software 130  
Dual Prescription Setting 35, 69

**E**

EMC Information 155  
EPAP 76  
Event Log 83  
Exhalation Devices  
    Cleaning 119  
Exhalation Porting Block 17  
Exhalation Porting Blocks 55  
External Battery Connector 18

**F**

Flex 90  
Flex Comfort Feature 30  
    Bi-Flex 30  
    C-Flex 30

Flow Pattern 78  
    Ramp 33  
    Square 33  
Flow Trigger Sensitivity 75  
Front Panel  
    AC Power LED 16  
    Audio Pause Button 15  
    Keypad Backlight LEDs 16  
    Left/Right Buttons 16  
    Red Alarm LED 16  
    Start/Stop Button 15  
    Up/Down Button 15  
    Yellow Alarm LED 16

**H**

High Minute Ventilation 73  
High Respiratory Rate 73  
Humidifier 127

**I**

In-Use Bag 130  
IP Address Mode Setting 81  
IPAP Max Pressure 76  
IPAP Min Pressure 76

**K**

Keypad Backlight 80  
Keypad Lock Feature 59, 80

**L**

Language Setting 79  
LCD Brightness Setting 80  
Low Respiratory Rate 74

**M**

Main Menu Screen 87  
 Menu Access 79, i  
   Full Menu i  
   Limited Menu i  
 Monitor Screen 60  
   Indicators 62  
 My Settings Menu 89  
   Flex 90  
   Ramp Start Pressure 89  
   Rise Time 89

**O**

Operational Hours 82  
 Options Menu 79  
 Oxygen Valve Connector 18

**P**

Passive Exhalation Device 53  
 Patient Circuit  
   Cleaning 118  
 PC-SIMV Mode 25, 78  
 Positive End Expiratory Pressure (PEEP) 78  
 Pressure Control Mode 24  
 Pressure Control Ventilation 19, 21, 23  
 Pressure Units 79  
 Primary Prescription Setting 88

**R**

Ramp Feature 31  
 Ramp Start Pressure 74, 89  
 Remote Alarm 98  
 Remote Alarm Connector 18  
 Rise Time 32, 89

**S**

Screen Saver 80  
 Secondary Prescription Setting 88  
 Secure Digital (SD) Card 17, 129  
 Sensitivity 36  
   Digital Auto-Trak Sensitivity  
     Leak Tolerance 36  
     Flow Trigger 36  
 Serial Connector 18  
 Settings and Alarms Tests 134  
 Setup Screen i  
 Sigh Feature 78  
 SIMV Mode 28, 79  
 Specifications  
   Control Accuracy 146  
   Electrical 146  
   Environmental 145  
   Pressure 146  
   Standards Compliance 145  
 Spontaneous Mode 22, 75  
 Spontaneous/Timed Mode 23, 77  
 Supplemental Oxygen 57, 127  
 System Checkout Procedures 133

**T**

Timed Mode 24, 77, 78  
 Time Format 81  
 Trigger Type  
   Auto-Trak 75  
   Flow Trigger 75  
 Troubleshooting 123

**V**

Volume Control Ventilation 19



**W**

Warnings 3

Warranty 163

Water Trap 130

# Limited Warranty

Respironics, Inc. warrants that the **Trilogy100** system shall be free from defects of workmanship and materials and will perform in accordance with the product specifications for a period of two (2) years from the date of sale by Respironics, Inc. to the dealer. If the product fails to perform in accordance with the product specifications, Respironics, Inc. will repair or replace – at its option – the defective material or part. Respironics, Inc. will pay customary freight charges from Respironics, Inc. to the dealer location only. This warranty does not cover damage caused by accident, misuse, abuse, alteration, and other defects not related to material or workmanship.

Respironics, Inc. disclaims all liability for economic loss, loss of profits, overhead, or consequential damages which may be claimed to arise from any sale or use of this product. Some states do not allow the exclusion or limitation of incidental or consequential damages, so the above limitation or exclusion may not apply to you.

Accessories and replacement parts, including, but not limited to, circuits, tubing, leak devices, exhaust valves, filters and fuses, are not covered under this warranty. However, Respironics warrants that the Product's internal and detachable battery (where supplied) will be free from defects in material and workmanship, under normal and proper use and when correctly maintained in accordance with applicable instructions, for a period of 90 days from the date of shipment by Respironics to the original purchaser. This warranty does not apply to batteries that are dropped, misused, altered or otherwise damaged after they are shipped.

This warranty is given in lieu of all other express warranties. In addition, any implied warranties – including any warranty of merchantability or fitness for the particular purpose – are limited to two years. Some states do not allow limitations on how long an implied warranty lasts, so the above limitation may not apply to you. This warranty gives you specific legal rights, and you may also have other rights which vary from state to state.

To exercise your rights under this warranty, contact your local authorized Respironics, Inc. dealer or contact Respironics, Inc. at:

1001 Murry Ridge Lane  
Murrysville, Pennsylvania 15668-8550  
1-724-387-4000