

Leading Therapy
in a New
Direction!

OptiFlex³

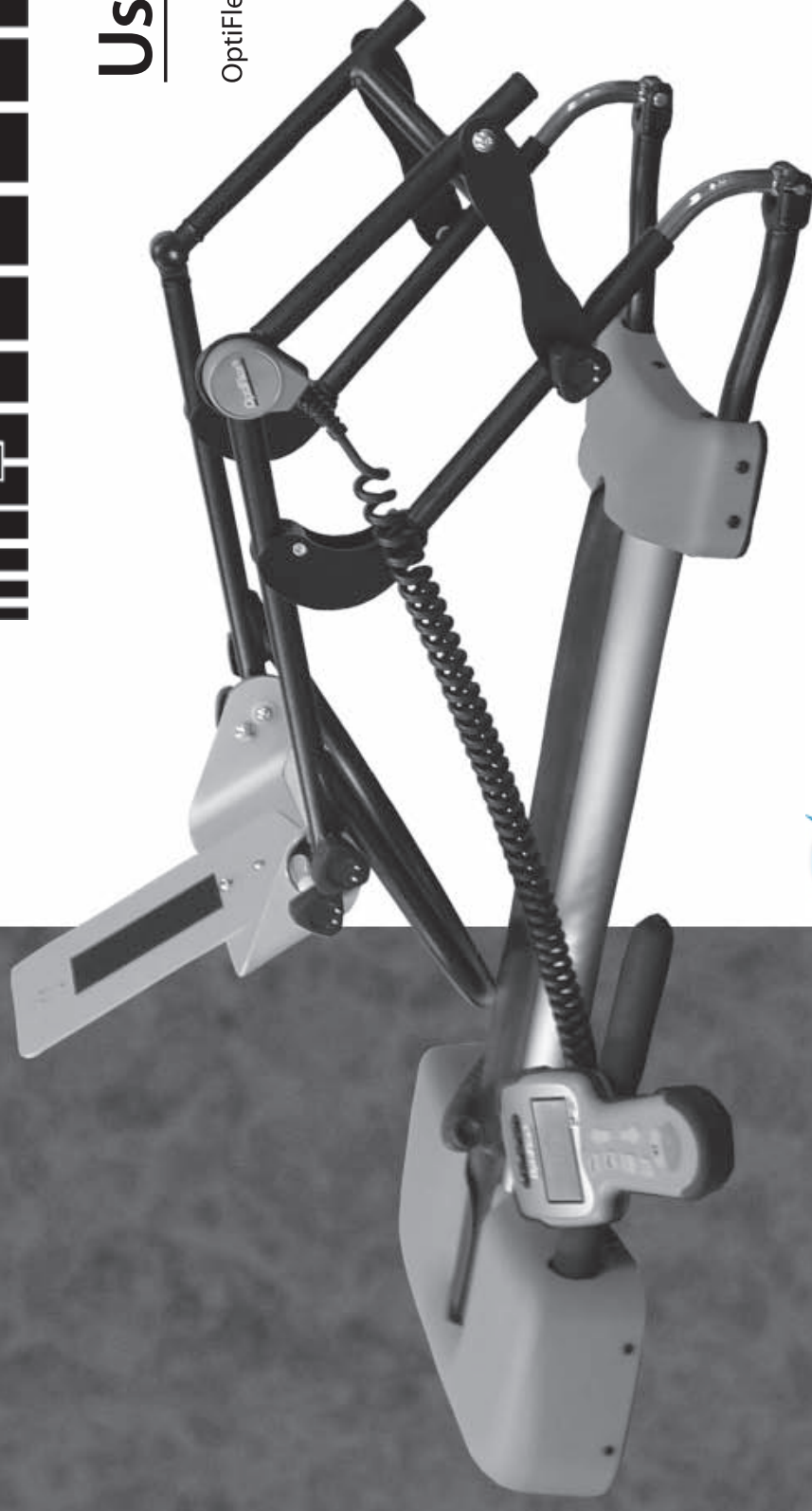

User Manual

Model 2090

OptiFlex 3 Continuous Passive Motion Unit



























ActiveForever.com

Discount Therapy, Fitness, Pain Relief & Medical Equipment

SCOTTSDALE • 1-800-377-8033 • PEORIA
480-767-6800 • 623-215-8470

TABLE OF CONTENTS

	FOREWORD	1
	Product Description	1
	ABOUT OPTIFLEX CPM UNIT	2-4
	Precautionary Instructions	2
	Cautions	3
	Warnings	4
	Dangers	4
	NOMENCLATURE	5-11
	Unit Familiarization	5
	Pendant Familiarization	6
	Pendant Functions and Use	7-11
	SPECIFICATIONS	12
	Technical Specifications	12
	Additional Definitions	12
	SETUP	13-16
	Unit Placement and Softgoods Installation	13
	New Patient Setup	14-15
	Pediatric Footplate Setup	16
	Accessories	16
	TROUBLESHOOTING	17
	MAINTENANCE	18
	Cleaning	18
	Service	18
	WARRANTY	19

FOREWORD

OptiFlex® 3 Continuous Passive Motion (CPM) Therapy Unit

This manual has been written for the operators of the OptiFlex 3 Continuous Passive Motion (CPM) Therapy Unit. It contains general instructions for operation, precautionary instructions, and maintenance recommendations. In order to obtain maximum life and efficiency from your OptiFlex 3 CPM Unit, and to assist in the proper operation of the unit, read and understand this manual thoroughly.

The specifications put forth in this manual were in effect at the time of the publication. However, owing to Chattanooga Group's policy of continuous improvement, changes to these specifications may be made at any time without obligation on the part of Chattanooga Group.

Before administering any treatment to a patient, you should become acquainted with the operating procedures, as well as the indications, contraindications, warnings, and precautions.

Product Description

Continuous Passive Motion is a postoperative procedure designed to aid in patient recovery after joint surgery. This unit is typically used postoperatively for total knee replacement and Anterior Cruciate Ligament (ACL) repairs. After extensive joint surgery, if a patient fails to move the joint, tissue around the joint will become stiff and scar tissue will form, resulting in a joint with limited range of motion. By repeatedly flexing and extending the affected joint through a prescribed arc of motion for an extended period of time, the OptiFlex 3 CPM Unit lessens the adverse effects of immobilization and trauma on the knee joint.

ABOUT OPTIFLEX 3 CPM UNIT

PRECAUTIONARY INSTRUCTIONS

The precautionary instructions found in this section and throughout this manual are indicated by specific symbols. Understand these symbols and their definitions before operating this equipment. The definition of these symbols are as follows;



Caution-

Text with a "CAUTION" indicator will explain possible safety infractions that could have the potential to cause minor to moderate injury or damage to equipment.



Warning-

Text with a "WARNING" indicator will explain possible safety infractions that will potentially cause serious injury and equipment damage.



Danger-

Text with a "DANGER" indicator will explain possible safety infractions that are imminently hazardous situations that would result in death or serious injury.

NOTE:

Throughout this manual "NOTE" may be found. These Notes are helpful information to aid in the particular area or function being described.

ABOUT OPTIFLEX 3 CPM UNIT

CAUTION

- Read, understand and practice the precautionary and operating instructions found in this manual before operating or using the unit. Know the limitations and hazards associated with using the OptiFlex 3 Continuous Passive Motion (CPM) Therapy Unit. Observe any and all precautionary and operational decals placed on the unit.
- Only use OptiFlex 3 on firm, flat, level surfaces.
- Extreme caution should be taken when in use with or around children.
- Use OptiFlex 3 only for its intended purpose as described in this manual.
- Turn power switch off before unplugging unit from its power source.
- Do not use the cord to unplug the power cord from the unit. Grasp at the power cord base.
- Transport and store the OptiFlex 3 in temperatures between 0° and 140 °F (-18° to 60 °C) to prevent damage to the unit or its components.
- Use extra care when touching metal of OptiFlex 3 after exposure to cold or heat to prevent static shock to persons and or the unit.
- Condensation could result and damage OptiFlex 3 if unit is subjected to periods of low temperatures followed by periods of high temperatures.
- Use care when carrying, transporting or storing the OptiFlex 3 unit to prevent damage to the unit from dropping or improper transport and storage methods.

ABOUT OPTIFLEX 3 CPM UNIT

OptiFlex® 3 Continuous Passive Motion (CPM) Therapy Unit

WARNING

- U.S. Federal law restricts this device to sale by, or on the order of, a physician or licensed practitioner.
- Make certain that the unit is electrically grounded by connecting only to a grounded electrical service receptacle conforming to the applicable national and local electrical codes.
- Keep hair, loose clothing, loose bedding, fingers and toes away from the hinge components of the unit.
- Do not use the OptiFlex 3 outdoors or on wet surfaces. Use only on firm, flat, stable level surfaces to ensure stability of the unit while in operation.
- Materials of the unit may become flammable or combustible if exposed to a source of ignition.
- Heat generated within the pendant may cause ignition of the pendant if wrapped in bedding or other materials.
- Do not use OptiFlex 3 while smoking or around open flame.
- OptiFlex 3 has been designed for protection against the exposure of urinary incontinence. Precautionary measures should still be taken when any type of liquid comes in contact with an electrical apparatus.
- Always turn off and unplug unit from electrical source before servicing or cleaning. Failure to do so could result in electrical shock or personal injury.
- Handle the unit only when unit is dry and hands are dry to prevent electrical shock.
- Do not use the OptiFlex 3 as a toy.

DANGER

- Exercise caution when using accessories and auxiliary devices such as muscle stimulators, cold packs and other modalities. Route lead wires, hoses, tubes, etc. away from the working mechanism of the OptiFlex 3 to help prevent damage to the Optiflex 3 and any other modality used with it.
- Unconscious patients or patients under heavy influence of medication must be constantly attended and monitored while the OptiFlex 3 is in use.
- The OptiFlex 3 unit must be completely visible at all times during use. Never cover the unit with bedding or any other means of concealment while in operation.
- If the OptiFlex 3 is used in conjunction with the optional OptiFlex "T" trolley, make certain the OptiFlex 3 unit is resting on the mattress of the bed and the OptiFlex "T" is suspended with no weight on the casters to prevent possible movement of the unit and or possible injury to patient.

NOMENCLATURE

OptiFlex® 3 Continuous Passive Motion (CPM) Therapy Unit

UNIT FAMILIARIZATION

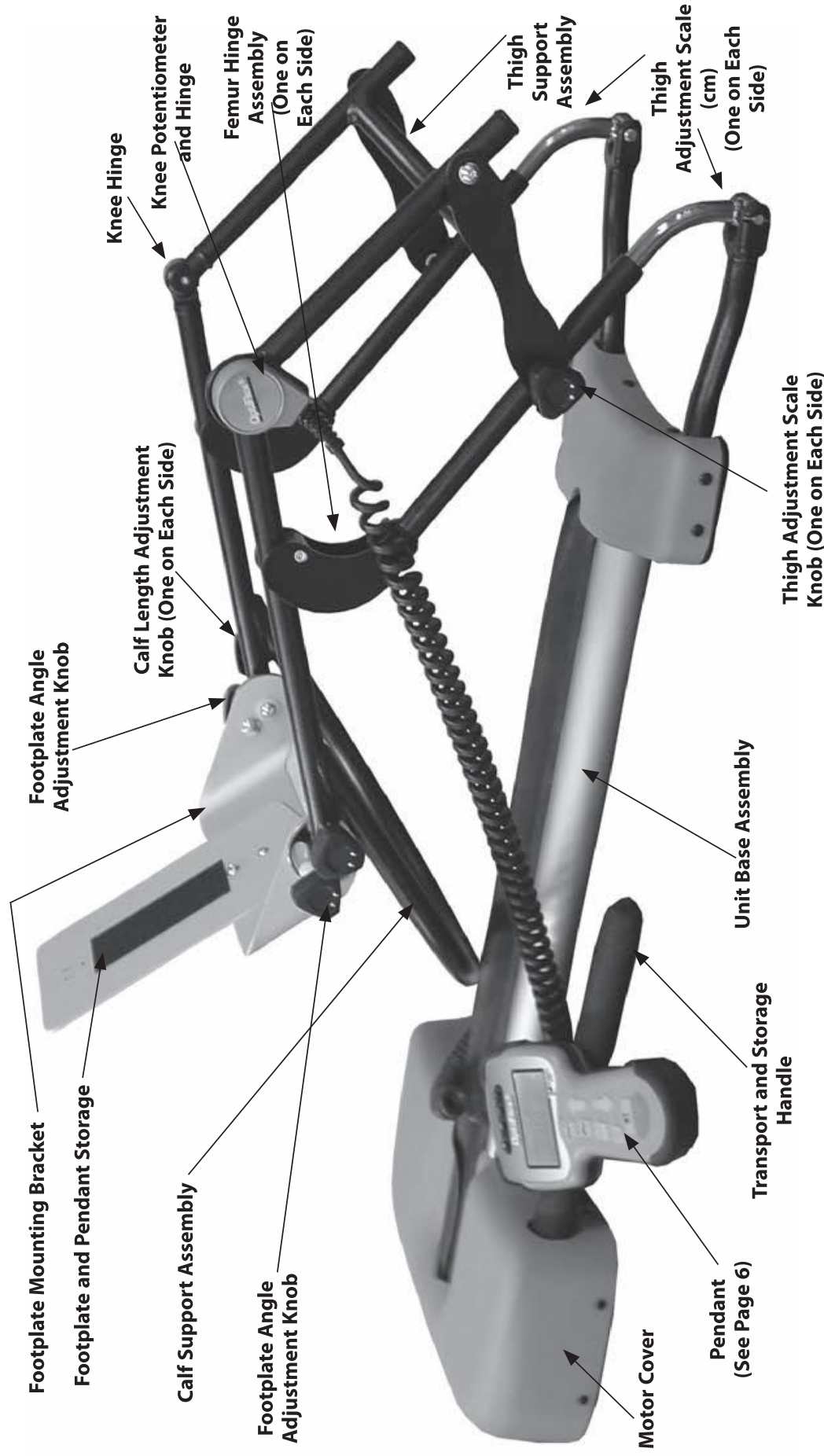

NOMENCLATURE

OptiFlex® 3 Continuous Passive Motion (CPM) Therapy Unit

PENDANT FAMILIARIZATION



Fast Back™
Carriage will slow down within 15° of the flexion angle.



Mode
Used with Fast Back, Oscillation Zone, and Progressive ROM*



Reset
Clear previous treatment settings and completed cycles.



Extension
Adjusts the extension angle.



Flexion
Adjusts the flexion angle.



Speed
Adjusts the speed of operation.



Extension/Flexion Delay
Allows user to program carriage to stop at both the extension and flexion angle for the time programmed.



Oscillation Zone™
Carriage will oscillate three times between the flexion angle and 10° less than the flexion angle.



Progressive ROM™ *
Unit will automatically increase the programmed flexion angle by 1° every hour up to a maximum of 5° per day.



Up Arrow
Allows user to increase treatment parameters.



Down Arrow
Allows user to decrease treatment parameters.



Comfort Zone™
Temporarily decreases the flexion ROM* when discomfort is experienced.



Start/Stop (Emergency Stop)
Start or Stop Treatment.

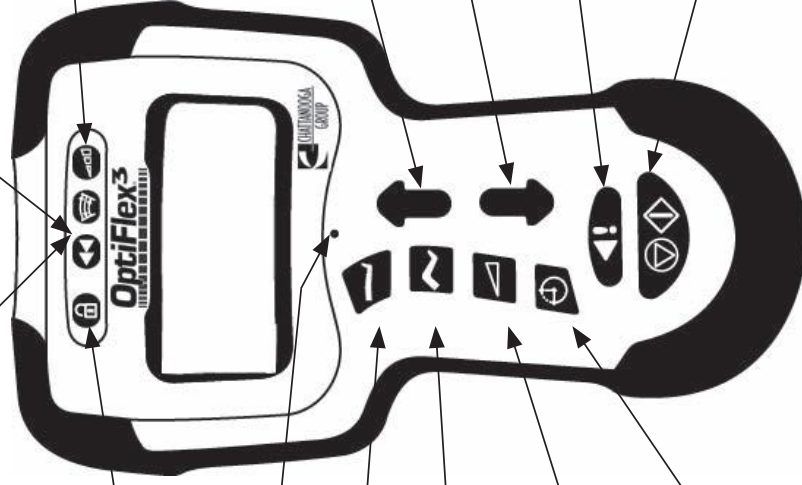

* Range of Motion

NOMENCLATURE

PENDANT FUNCTIONS AND USE

All user input and feedback is provided through the pendant. The following are descriptions of each button provided with OptiFlex® 3.

Extension: View and modify the extension angle parameter.

How to use: To view the extension angle, press and hold the Extension button. To modify the current extension angle, press and hold the Extension button while pressing either the Up or Down Arrow.



Flexion: View and modify the flexion angle parameter.

How to use: To view the flexion angle, press and hold the Flexion button. To modify the current flexion angle, press and hold the Flexion button while pressing either the Up or Down Arrow.



Speed: View and modify the speed parameter.

How to use: To view the speed, press and hold the Speed button. To modify the current speed, press and hold the Speed button while pressing either the Up or Down Arrow.



Extension/Flexion Delay: View and modify the delay time for the extension or flexion angles. Using Extension/Flexion Delay will cause the carriage to stop at the extension and flexion angle for the time programmed.



How to use: To view the extension/flexion delay time, press and hold the Extension/Flexion Delay button. You can set independent Delay times for extension and flexion. If an extension and or flexion delay time is required, simply hold down the Delay button and the Extension or Flexion button and use the Up or Down Arrows to adjust the time.

Up Arrow: Increases treatment parameters in conjunction with other buttons.

How to use: Select the specific function to increase (Speed, Extension, Flexion or Extension/Flexion Delay). While pressing and holding the appropriate button, use the Up Arrow to increase the value of the specified function.



Down Arrow: Decreases treatment parameters in conjunction with other buttons.

How to use: Select the specific function to decrease (Speed, Extension, Flexion or Extension/Flexion Delay). While pressing and holding the appropriate button, use the Down Arrow to decrease the value of the specified function.



Reset: Resets all parameter and patient counters to factory defaults.

How to Use: To reset patient compliance counters, press and hold lightly by inserting a paper clip and accept reset by pressing the Mode button. To display total unit run time and cycles, press and hold Reset for 3 seconds, the total unit time and cycles are temporarily displayed.



NOMENCLATURE

PENDANT FUNCTIONS AND USE



Start/Stop (Emergency Stop): Starts or stops the treatment.

How to Use: Press the Start/Stop (Emergency Stop) button to begin or end the treatment.

NOTE: When unit is stopped and the Start/Stop (Emergency Stop) button is pressed, the unit will immediately begin moving in the opposite direction of the last movement.



Comfort Zone™ : Temporarily decreases the flexion ROM when discomfort is experienced during treatment.

How to Use: Press and the carriage will immediately reverse direction to move toward the extension angle. For the next five cycles, the carriage will operate in a range 5° less than the angle where the button was pressed. The Comfort Zone Flexion Angle is 5° less than the angle where the button was pressed. Once five cycles are complete, the Comfort Zone Flexion Angle will be increased by 1° each consecutive cycle until it reaches the currently Programmed Flexion Angle. See Chart 1.

NOTE: If Comfort Zone is pressed within 30° of the currently Programmed Extension Angle, treatment will stop and the message "Comfort Zone Too Small" will be displayed.

CHART 1- COMFORT ZONE

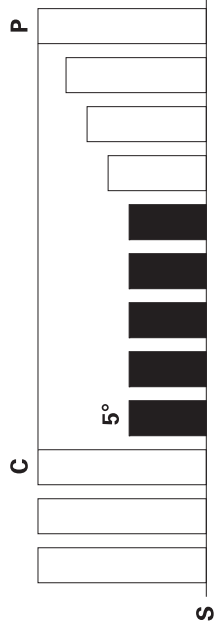

C = Comfort Zone activated temporary flexion limit established.

5° = 5° less than the angle where Comfort Zone was activated.

Upon completion of five cycles, ROM will increase by 1° each cycle until it reaches P.

P = Programmed Flexion angle.

S = Start/Finish.



WARNING

- If pain is severe, do not use the Comfort Zone function. Stop treatment immediately. Failure to stop treatment could result in tissue damage and could compromise the surgical repair.

NOMENCLATURE

PENDANT FUNCTIONS AND USE



Mode: Used together with Fast Back™, Oscillation Zone™ and Progressive ROM button to enable and disable the appropriate mode. All three modes or any combination may be used at once.

How to Use: Press Mode button along with desired function (Fast Back, Oscillation Zone and/or Progressive ROM).



Fast Back™ : When the carriage reaches 15° less than the Programmed Flexion Angle, it will begin to slow down. The deceleration rate will be half of the Programmed Speed when the carriage comes within 10° of the flexion angle. Upon reaching the flexion angle, the carriage will reverse direction and resume the Programmed Speed as it moves towards the extension angle. See Chart 2.

How to Use: While pressing and holding the Mode button, press the Fast Back button to enable the Fast Back mode.

NOTE: If both Fast Back and Oscillation Zone modes are enabled, the carriage will move at the slower of 75%/min. and half of the Programmed Speed while in the Oscillation Zone ROM.

CHART 2 - FAST BACK

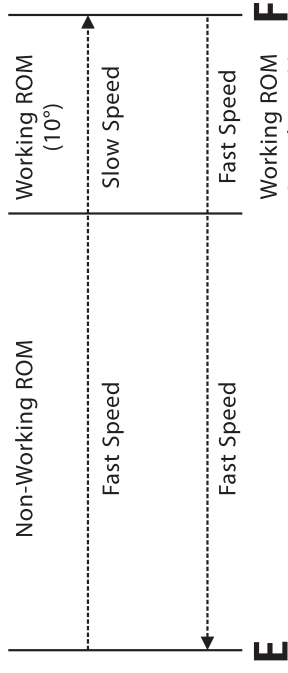

F = Programmed Flexion Angle
E = Programmed Extension Angle

NOMENCLATURE

PENDANT FUNCTIONS AND USE

Oscillation Zone™: When the carriage reaches the Programmed Flexion Angle, it will oscillate between the Programmed Flexion Angle and 10° less than the flexion angle, three times. The 10° range of motion is known as the Oscillation Zone ROM. While in the Oscillation Zone ROM, the carriage will move at 75%/min. or the Programmed Speed, whichever is slower. On the third oscillation cycle, the carriage will hold at the flexion angle for the Programmed Extension/Flexion Delay Time. See Chart 3.

How to Use: While pressing and holding the Mode button, press the Oscillation Zone button to enable the Oscillation Zone mode.

NOTE: If both Fast Back™ and Oscillation Zone modes are enabled, the carriage will move at the slower of 75%/min. and half of the Programmed Speed while in the Oscillation Zone ROM.

CHART 3- OSCILLATION ZONE

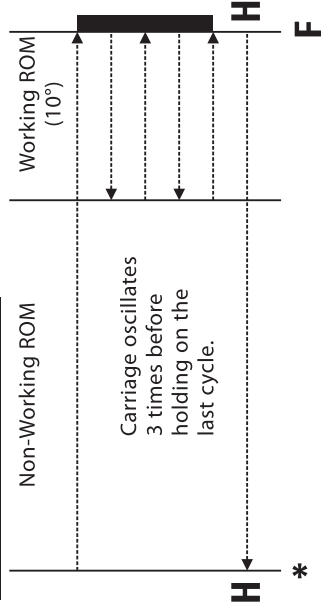

- * = Optional Hold on Extension / Flexion Limit
- H = Start / Finish
- F = Programmed Flexion Angle

Progressive ROM™: When Progressive ROM is activated, the unit will automatically increase the Programmed Flexion Angle by 1° every hour, up to a maximum of 5° per 24 hour period. See Chart 4.

How to Use: Press and hold the Mode button. Press the Progressive ROM button to enable the Progressive ROM mode. Set the desired Final Flexion Angle by pressing and holding the Flexion Button while using the Up and Down Arrows. Accept the Final Flexion Angle by pressing the Mode Button.

NOTE: The unit must run for a full hour at the entire ROM before the flexion angle will be increased. Decreasing the flexion angle will automatically deactivate this mode.

CHART 4- KNEE FLEXION ROM VS. TIME

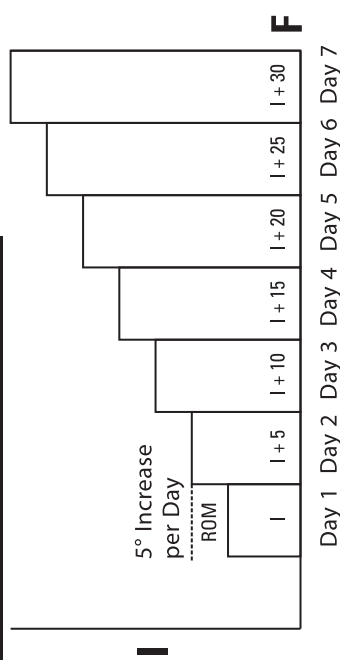

- I = Initial Knee Flexion ROM
- F = Final Knee Flexion ROM
- ROM** = $I + D_{(n-1)} \times 5$
where n is the number of days of therapy

NOMENCLATURE

PENDANT FUNCTIONS AND USE

Independent Delay Time

You can set independent Delay times for extension and flexion. If an extension and or flexion delay time is required, simply hold down the Delay button and the Extension or Flexion button and use the Up or Down Arrows to adjust the time.

Selectable Scrolling

The scrolling feature is disabled at the factory. Should you desire to enable this feature, simply press and hold the Delay and Mode buttons. The display will scroll patient data for two cycles then return to displaying Current Carriage Angle.

Patient Lock-Out

The Patient Lock-Out feature prevents the patient from changing any parameter except Comfort Zone™ and Start/Stop (Emergency Stop). To enable the Patient Lock-Out feature: Press and hold the Up Arrow and the Mode button for three seconds. A single short beep will confirm that the feature has been activated.

Repeating the above sequence will deactivate the feature. A single short beep will confirm that the feature has been deactivated.

Language Selection

To select display language, press and hold the Mode and Extension buttons simultaneously for 3 seconds. Use and arrows to select desired language and then press Mode to accept.

Force Reversal

Force Reversal is a programmed setting that will automatically reverse the direction of the leg orthosis if the device detects a greater amount of resistance than what is programmed. Force Reversal allows you to set the amount of force required to passively move the joint without causing unnecessary pain or damage to the surgery.

The Force Reversal feature has 10 sensitivity settings, with a minimum setting of 1.

NOTE: The maximum setting of 10 is the factory default and functions as carriage obstruction.

To change the Force Reversal sensitivity setting, press and hold the Speed and Extension/Flexion Delay buttons simultaneously and use the down arrow to decrease the sensitivity setting.

SPECIFICATIONS







OptiFlex® 3 Continuous Passive Motion (CPM) Therapy Unit

TECHNICAL SPECIFICATIONS

MODEL 2090	
Input:	100 - 240 VAC~50/60 Hz, 75 VA
Weight:	27 lbs (12 kg)
Length:	37 in (94 cm)
Electrical Class:	Class I, Type B 
Operation	
Knee Flexion ROM Limit:	120°
Knee Extension Limit:	10° Hyper Extension
Knee Speed Range :	30°/min. to 150°/min. Nominal
Maximum Patient Weight:	350 lbs (159kg)
Calf Length Range: (knee joint to sole of foot)	10 to 23.5 in (25.4 to 59.7 cm)
Thigh Length Range: (hip joint to knee joint)	12 to 19 in (30.5 to 48.3 cm)
Transportation and Storage	
Unit should be transported and stored within the following conditions:	
Temperature:	0° - 140°F (32° - 60°C)
Humidity:	0% - 75% Relative Humidity

ADDITIONAL DEFINITIONS:

ROM- "Range Of Motion".

	Standby Power ON		Standby Power OFF
	Emergency Stop		Start
	Type B Equipment		Attention, Consult Accompanying Documents

OptiFlex® 3 complies with the following Safety Standards:

UL 60601-1

CAN/CSA C22.2 No. 601.1-M90 w/AZ

IEC/EN 60601-1

IEC/EN 60601-1-2

Meets MDD 93/42/EEC, CE 0413

Type "B" Equipment, Class I

Suitable for continuous operation

SETUP

UNIT PLACEMENT AND SOFTGOODS INSTALLATION

1. Place the unit on a level surface.

WARNING

- Place the unit on a level surface. Use of the unit on unstable surfaces do not give the stability the unit requires. If the unit becomes unstable, serious injury to the patient may occur.
- The Softgoods Kit is for single patient use only. A new Softgoods Kit must be used for each new patient.
- Make certain that the unit is electrically grounded by connecting only to a grounded electrical service receptacle conforming to the applicable national and local electrical codes.

2. Install the Softgoods Kit to the carriage of the OptiFlex 3. Use the installation instructions packaged with the Softgoods kit.

CAUTION

- Chattanooga Group Softgoods Kit (Part Number 20533) is designed specifically for the OptiFlex 3 unit. Attempted use of any other brand of CPM Softgoods Kit may cause malfunction of the unit and injury or discomfort to the patient.

3. Plug the unit into an approved grounded outlet. Turn the power on.



SETUP

NEW PATIENT SETUP



Reset Pendant

Depress the Reset on the Pendant (i.e. paper clip, pen, etc.). With Reset depressed, press the Mode Button.

The Unit is now ready for new patient parameter input. Refer to pages 7 through 11.



Adjust OptiFlex Femur Component

Loosen the Thigh Adjustment Scale Knobs on each side of the unit. Raise or lower the unit to the measured distance. Tighten the Thigh Adjustment Scale Knobs.



Measuring Patient

Measure the patient from the hip joint (greater trochanter) to the knee in centimeters.



Placing Patient

Place the OptiFlex 3 unit, with Softgoods Kit installed, under the patient's leg.

Align patient's knee with the unit hinge.

SETUP

NEW PATIENT SETUP



Securing Patient

After patient is positioned and all adjustments are made, secure the patient to the OptiFlex 3 using the strap included in the Softgoods Kit.



Comfort Zone™

If the patient experiences discomfort, the Comfort Zone button may be pressed and the carriage will immediately reverse direction and move toward the extension angle. For the next five cycles, the carriage will operate in a range 5° less than the angle where the button was pressed. Once five cycles are complete, the Comfort Zone Flexion Angle will increase by 1° each cycle until it reaches the Programmed Flexion Angle.

Starting/Stopping Treatment

After all parameters have been made, see pages 7 through 11, start treatment by pressing the Start/Stop (Emergency Stop) button.



Emergency Stop

Should the patient need to stop the treatment, they may press the Start/Stop (Emergency Stop) button once and treatment will immediately stop.

SETUP

PEDIATRIC FOOTPLATE SETUP



Pediatric Footplate

Remove footplate from unit. Lay aside for re-installation.



Loosen the footplate adjustment knobs and rotate footplate support as shown. Tighten the footplate adjustment knobs.

Re-install footplate.



Loosen the tibial adjustment knobs and pull out the footplate assembly.



Rotate the footplate assembly 180° and reinsert into the tibial adjustment tubes. Tighten the tibial adjustment knobs.

ACCESSORIES

Patient Kits

20533 – OptiFlex Patient Kit
40128 – 34" Strap Kit

OptiFlex 3 CPM Unit Accessories

89900 – OptiFlex Bedmount
89928 – OptiFlex Storage Rack
2031 – OptiFlex T Trolley
2032 – OptiFlex Lift

TROUBLESHOOTING

The OptiFlex 3 CPM Therapy Unit is designed with patient safety in mind. An error can be caused by both external and internal disturbances.

Before calling for service, carefully review this operator's guide. In the event you are still unable to correct the problem, contact your Chattanooga Group dealer for all repair service. Be certain to specify your serial number and a detailed description of the issue you encountered.

ERROR	ERROR DEFINITION	PROBABLE CAUSE	POSSIBLE REMEDY
1 & 2	Pendant isn't communicating correctly with unit.	Defective Cable, Pendant or Main Board.	<ul style="list-style-type: none"> Replace the Cable, Pendant or Main Board. Return to Chattanooga Group for service.
3	Error reading the EEPROM on the motor pcb.	Defective Cable, Pendant or Main Board.	<ul style="list-style-type: none"> Replace the Cable, Pendant or Main Board. Return to Chattanooga Group for service.
5	RTC battery voltage is too low indicating bad battery.	Pendant Battery Voltage is low.	<ul style="list-style-type: none"> Replace the Pendant Battery. Return to Chattanooga Group for service.
6	A general error on the motor pcb has occurred.	Main Board Failure.	<ul style="list-style-type: none"> Replace the Main Board. Return to Chattanooga Group for service.
7	The angle pot sensor is out of range.	Carriage angle below -10° limit.	<ul style="list-style-type: none"> Loosen the Femur Adjustment Knobs. Raise the carriage to above zero and tighten the Femur Adjustment Knobs. Turn the unit off and Back on with the power switch.
8	The angle pot is not changing when the carriage is supposed to be moving.	Carriage obstruction or the Angle Pot Screw is loose.	<ul style="list-style-type: none"> Remove the obstruction. Tighten the Angle Pot Screw. Return to Chattanooga Group for service.
9	The motor tachometer does not match expected value.	Main Board Failure.	<ul style="list-style-type: none"> Replace the Main Board. Return to Chattanooga Group for service.
10	The motor pcb has not communicated with the pendant in a reasonable amount of time.	Main Board Failure.	<ul style="list-style-type: none"> Replace the Main Board. Return to Chattanooga Group for service.
11	The motor pcb was reset via the watchdog.	Main Board Failure.	<ul style="list-style-type: none"> Replace the main board. Return to Chattanooga Group for service.

MAINTENANCE

OptiFlex® 3 Continuous Passive Motion (CPM) Therapy Unit

CLEANING

After each use, clean the unit using a soft cloth dampened with water and a mild antibacterial detergent.

SERVICE

Should the OptiFlex 3 CPM unit require service, contact the selling dealer or Chattanooga Group Service Department. All returned units to the factory for service must include the following:

WARRANTY REPAIR/OUT OF WARRANTY REPAIR

1. Written statement containing the following information:
 - RA Number - Obtain from factory
 - Unit Model Number
 - Unit Serial Number
 - Contact person with phone and fax numbers
 - Billing address (for out of warranty repair)
 - Shipping address (where to ship unit after repair)
 - Detailed description of problem or symptoms
2. Copy of original invoice issued at purchase of the unit.
3. Ship unit to Factory in the original container with all accessories and information as required in item one (1) above to:

Chattanooga Group
4717 Adams Road
Hixson, TN 37343 USA
Phone: USA: (800) 592-7329
Fax: (423) 875-5497
Canada: (800) 361-6661
Outside USA: +1 (423) 870-7200
Outside USA Fax: +1 (423) 870-2046

Service to these units should be performed only by Service Technicians certified by Chattanooga Group.

WARRANTY

OptiFlex® 3 Continuous Passive Motion (CPM) Therapy Unit

Chattanooga Group ("Company") warrants that the OptiFlex 3 Model 2090 Continuous Passive Motion (CPM) therapy unit ("Product") is free of defects in material and workmanship. This warranty shall remain in effect for two years (24 months) from the date of original consumer purchase. If this Product fails to function during the two year warranty period due to a defect in material or workmanship, Company or the selling dealer will repair or replace this Product without charge within a period of thirty (30) days from the date on which the Product is returned to the Company or the dealer.

All repairs to the Product must be performed by a service center authorized by the Company. Any modifications or repairs performed by unauthorized centers or groups will void this warranty. The warranty period for accessories is 30 days. Accessories consist of Patient Softgoods Kit shipped with the unit.

To participate in warranty coverage, this Product's warranty registration card (included with Product) must be filled out and returned to the Company by the original owner within ten (10) business days of purchase.

This Warranty Does Not Cover:

Replacement parts or labor furnished by anyone other than the Company, the selling dealer or a certified Company service agent.
Defects or damage caused by labor furnished by someone other than Company, the selling dealer or a certified Company service agent.
Any malfunction or failure in the Product caused by product misuse, including, but not limited to, the failure to provide reasonable and necessary maintenance or any use that is inconsistent with the Product User Manual.

COMPANY SHALL NOT BE LIABLE IN ANY EVENT FOR INCIDENTAL OR CONSEQUENTIAL DAMAGES.

Some states do not allow the exclusion or limitation of incidental or consequential damages, so the above limitation or exclusion may not apply to you. To obtain service from Company or the selling dealer under this warranty:

1. A written claim must be made within the warranty period to the Company or the selling dealer. Written claims made to the Company should be sent to:

4717 Adams Road
P.O. Box 489
Hixson, TN 37343 USA
Phone: USA: (800) 592-7329
Fax: (423) 875-5497
Canada: (800) 361-6661
Outside USA: +1 (423) 870-7200
Outside USA Fax: +1 (423) 870-2046

2. The Product must be returned to the Company or the selling dealer by the owner.

This warranty gives you specific legal rights and you may also have other rights which vary from state to state or location to location. The Company does not authorize any person or representative to create for it any other obligation or liability in connection with the sale of the Product. Any representation or agreement not contained in the warranty shall be void and of no effect.

THE FOREGOING WARRANTY IS IN LIEU OF ALL OTHER WARRANTIES, EXPRESSED OR IMPLIED, INCLUDING ANY WARRANTY OR MERCHANTABILITY OR FITNESS FOR A PARTICULAR PURPOSE.



ActiveForever.com

Discount Therapy, Fitness, Pain Relief & Medical Equipment

SCOTTSDALE • 1-800-377-8033 • PEORIA
480-767-6800 • 623-215-8470