CASMED 740

Vital Signs Monitor



User's Manual

CASMEDTM
FOR WHAT'S VITAL

CE 0086

THE CASMED 740 VITAL SIGNS MONITOR

FEATURES

- CASMED 740 - 1 Non-Invasive Blood Pressure and Pulse Rate.
- CASMED 740 - 2 Non-Invasive Blood Pressure, Pulse Rate and Pulse
Oximeter.
or
Non-Invasive Blood Pressure, Pulse Rate and Temperature.
- CASMED 740 - 3 Vital Signs Monitor with Non-Invasive Blood Pressure,
Pulse Rate, Pulse Oximeter and Predictive Temperature.

IMPORTANT:

This manual addresses all parameters of the CASMED 740 Vital Signs Monitor. You may have purchased a model that does not have all the parameters referred to in the manual.

THIS MANUAL REMAINS SUITABLE FOR USE!

Please refer to sections of the manual and the Quick Reference Guide that are applicable for the model purchased.

WARNING:

The CASMED 740 Monitor is to be operated by qualified personnel only. Before use, carefully read this manual, including accessory directions for use, all precautionary information, and specifications. The user must check that the equipment functions safely and see that it is in proper working condition before being used.

In the U.S. the following Caution applies:

CAUTION:
Federal law restricts this device to sale by or on the order of a physician or properly licensed practitioner.

First Printing: 12/2006

INITIAL SETUP

Before using the monitor for the first time, the following items should be performed:

- Select the operating Language
- Select the Temperature scale (if installed)
- Set the monitor's Date and Time

These items are found in the monitor's Configuration Menu.

To enter the Configuration Menu, press and hold the ALARM LIMITS and VOLUME push button keys while turning "ON" the unit.



NOTE:

Unit will beep once and software version will be displayed.
Steps must be completed within 60 seconds or process must be restarted.

Language

Press until the menu for language is displayed. Press either or to make your selection.

Temperature Scale (if installed)

Press until the menu for temperature scale is displayed. Press either or to make your selection.

Date

Press until the date is displayed. The day parameter is flashing. Press either or to change the Day.

Press one time. Press either or to change the Month.

Press one time. Press either or to change the Year.

Time

Press one time. Press either or to change the Hour.

Press one time. Press either or to change the Minute.

Press one time to exit and save your changes.

This page is intentionally left blank

Manufacturers Declaration of Conformity Electronic Emissions and Immunity

The Model 740 Monitor is intended for use in the electromagnetic environment specified below. The customer or the user of the Model 740 Monitor should assure it is used in such an environment.

Emissions Test	Compliance	Electromagnetic Environment
RF emissions – CISPR 11	Group 1	The Model 740 Monitor uses RF energy only for its internal function. Therefore, its RF emissions are very low and are not likely to cause any interference in nearby electronic equipment.
RF emissions – CISPR 11	Class B	The Model 740 Monitor is suitable for use in all establishments, including domestic establishments and those directly connected to the public low-voltage power supply network that supplies buildings used for domestic purposes.
Harmonic emissions IEC 61000-3-2	Class B	
Voltage fluctuations / flicker emissions	Complies	

Immunity Test	IEC 60601 Test Level	Compliance Level	Electromagnetic Environment Guidance
Electrostatic discharge (ESD) IEC 61000-4-2	+/-6 kV contact +/-8 kV air	+/-6 kV contact +/-8 kV air	Floors should be wood concrete or ceramic tile. If floors are covered with synthetic material, the relative humidity should be at least 30%.
Electrical fast transient/burst IEC 61000-4-4	+/-2 kV for power supply lines +/-1 kV for input/output lines	+/-2 kV for power supply lines +/-1 kV for input/output lines	Mains power quality should be that of a typical commercial or hospital environment.
Surge IEC 61000-4-5	+/-1 kV differential mode +/-2 kV common mode	+/-1 kV differential mode +/-2 kV common mode	Mains power quality should be that of a typical commercial or hospital environment.
Voltage Dips, short interruptions and voltage variations on power supply input lines IEC 61000-4-11	< 5% U_T (>95% dip in U_T) for 0.5 cycle. 40% U_T (60% dip in U_T) for 5 cycles. 70% U_T (30% dip in U_T) for 25 cycles. < 5% U_T (> 95% dip in U_T) for 5 seconds.	< 5% U_T (>95% dip in U_T) for 0.5 cycle. 40% U_T (60% dip in U_T) for 5 cycles. 70% U_T (30% dip in U_T) for 25 cycles. < 5% U_T (> 95% dip in U_T) for 5 seconds.	Mains power quality should be that of a typical commercial or hospital environment. If user of the Model 740 Monitor requires continued operation during power mains interruptions, it is recommended that the Model 740 Monitor be powered from an uninterruptible power supply or a battery.
Power frequency (50/60 Hz) magnetic field IEC 61000-4-8	3 A/m	3 A/m	Power frequency magnetic fields should be at levels characteristic of a typical location in a typical commercial or hospital environment.

NOTE: U_T is the A.C. mains voltage prior to application of the test level.

Guidance and Manufacturer's Declaration – Electromagnetic Immunity

The Model 740 Monitor is intended for use in the electromagnetic environment specified below. The customer or the user of the Model 740 Monitor should insure that it is used in such an environment.

Immunity Test	IEC 60601 Test Level	Compliance Level	Electromagnetic Environment - Guidance
<p>Conducted RF IEC 61000-4-6</p> <p>Radiated RF IEC 61000-4-3</p>	<p>3 Vrms 150 kHz to 80 MHz</p> <p>3 V/m 80 MHz to 2.5 GHz</p>	<p>3 Vrms</p> <p>3 V/m</p>	<p>Portable and mobile RF communications equipment should be used no closer to any part of the Model 740 Monitor, including cables, than the recommended separation distance calculated from the equation applicable to the frequency of the transmitter.</p> <p>Recommended separation distance:</p> <p>$d = 1.2\sqrt{P}$</p> <p>$d = 1.2\sqrt{P}$ 80 MHz to 800 MHz $d = 2.3\sqrt{P}$ 800 MHz to 2.5 GHz</p> <p>Where P is the maximum output power rating of the transmitter in watts according to the transmitter manufacturer and d is the recommended separation distance in meters.</p> <p>Field strengths from fixed RF transmitters, as determined by an electromagnetic site survey ^a, should be less than the compliance level in each frequency range. ^b</p> <p>Interference may occur in the vicinity of equipment marked with the following symbol:</p> 

NOTE 1 At 80 MHz and 800 MHz, the higher frequency range applies.

NOTE 2 These guidelines may not apply in all situations. Electromagnetic propagation is effected by absorption and reflection from structures, objects and people.

^a Field strengths from fixed transmitters, such as base stations for radio (cellular / cordless) telephones and land mobile radios, amateur radio, AM and FM radio broadcast and TV broadcast cannot be predicted theoretically with accuracy. To assess the electromagnetic environment due to fixed RF transmitters, an electromagnetic site survey should be considered. If the measured field strength in the location in which the Model 740 Monitor is used exceeds the applicable RF compliance level above, the Model 740 Monitor should be observed to verify normal operation. If abnormal performance is observed, additional measures may be necessary, such as re-orienting or relocating the Model 740 Monitor.

^b Over the frequency range 150 kHz to 80 MHz, field strengths should be less than 3 V/m.

Recommended Separation Distances Between Portable and Mobile RF Communications Equipment and the Model 740 Monitor

The Model 740 Monitor is intended for use in an electromagnetic environment in which radiated RF disturbances are controlled. The customer or the user of the Model 740 Monitor can help prevent electromagnetic interference by maintaining a minimum distance between portable and mobile RF communications equipment (transmitters) and the Model 740 Monitor as recommended below, according to the maximum output power of the communications equipment.

Rated maximum output power of transmitter (Watts)	Separation distance according to frequency of transmitter (Meters)		
	150 kHz to 80 MHz $d = 1.2\sqrt{P}$	80 MHz to 800 MHz $d = 1.2\sqrt{P}$	800 MHz to 2.5 GHz $d = 2.3\sqrt{P}$
0.01	0.12	0.12	0.23
0.1	0.38	0.38	0.73
1	1.2	1.2	2.3
10	3.8	3.8	7.3
100	12	12	23

For transmitters operating at a maximum output power not listed above, the recommended separation distance d in meters can be estimated using the equation applicable to the frequency of the transmitter, where P is the maximum output power rating of the transmitter in watts according to the transmitter manufacturer.

NOTE 1 At 80 MHz and 800 MHz, the separation distance for the higher frequency range applies.

NOTE 2 These guidelines may not apply in all situations. Electromagnetic propagation is affected by absorption and reflection from structures, objects and people.

WARRANTY POLICY

MONITOR (CASMED 740)

NOTE:

For all U.S. government accounts please see the Warranty Addendum at www.va.casmed.com.

All products are sold by CAS Medical Systems, Inc. under the warranties set forth in the following paragraphs. Such warranties are extended only with respect to the purchase of this product directly from CAS Medical Systems, Inc. or CAS's Authorized Distributors as new merchandise and are extended to the first buyer thereof, other than for resale.

The CASMED 740 Monitor is warranted for a period of twenty-four (24) months. All products, excluding printers, if applicable, are warranted to be free from functional defects in materials and workmanship and to conform to the description of the product contained in the Operator/Service Manual, published specifications, and accompanying labels and/or inserts, provided that the same is properly operated under conditions of normal use in accordance with applicable safety and regulatory requirements, and that replacements and repairs are made in accordance with the instructions provided by CAS Medical Systems, Inc.

The same warranty conditions are made for a period of twelve (12) months with respect to printer and battery. A ninety (90) days warranty is provided for non-disposable accessories such as reusable SpO₂ sensors, reusable temperature probes and other accessories provided by CAS as part of the original purchase. CAS warrants disposable or single-patient-use products, including blood pressure cuffs, for out-of-box failure only. Reusable blood pressure cuffs are warranted for one year. Where the accessory is not a CAS Medical Systems, Inc. manufactured product, the manufacturer's own warranty applies. Warranty of accessories purchased separately from listed suppliers will be the responsibility of such listed suppliers. Damage to any part through misuse, neglect, or accident, or by affixing any accessories or attachments other than CAS, Statcorp, Masimo®, Nellcor®, Nonin®, and Welch Allyn® manufactured accessories or attachments, is not covered by this warranty.

The foregoing warranties shall not apply if the product has been configured, modified, adjusted or repaired other than by CAS Medical Systems, Inc. or by persons expressly authorized by CAS Medical Systems, Inc., or not in accordance with written instructions provided by CAS Medical Systems, Inc., or if the product has been subjected to misuse, negligence, or accident. This warranty is void if the printer is used with any paper other than that specified by CAS Medical Systems, Inc.

CAS reserves the right to perform warranty service operations in its own factory, at an authorized repair facility, or at the customers' site. CAS Medical Systems, Inc.'s sole and exclusive obligation and Buyer's sole and exclusive remedy under the above warranties, is limited to repairing or replacing, free of charge, a product which is reported in writing or via telephone to CAS Medical Systems, Inc., has a Return Material Authorization (RMA) number assigned and which is returned during normal business hours, transporting charges prepaid to:

CAS Medical Systems, Inc.
44 East Industrial Road
Branford, CT. 06405 USA
Telephone: +1 203 488 6056
Fax: +1 203 488 9438
E-mail: custsrv@casmed.com

CAS MEDICAL SYSTEMS, INC. SHALL NOT BE OTHERWISE LIABLE FOR ANY DAMAGES INCLUDING, BUT NOT LIMITED TO, INCIDENTAL DAMAGES, CONSEQUENTIAL DAMAGES OR SPECIAL DAMAGES.

THERE ARE NO EXPRESS OR IMPLIED WARRANTIES WHICH EXTEND BEYOND THE WARRANTIES HEREINABOVE SET FORTH. CAS MEDICAL SYSTEMS, INC. MAKES NO WARRANTY OF MERCHANTABILITY OR FITNESS FOR A PARTICULAR PURPOSE WITH RESPECT TO THE PRODUCT OR PARTS THEREOF.

HOW TO CONTACT US

<p>CAS Medical Systems, Inc 44 East Industrial Road Branford, CT 06405 U.S.A.</p> <p>Phone: (800) 227-4414 (203) 488-6056</p> <p>Fax: (203) 488-9438</p> <p>E-Mail: custsrv@casmed.com sales@casmed.com techsrv@casmed.com</p> <p>Web: www.casmed.com</p>	<p>Authorized Representative in European Union:</p> <p>Mossa Consulting GmbH Bollbrügg 22 23570 Lübeck Germany</p> <p>Phone: +49-4502-880-557</p> <p>Fax: +49-4502-880-559</p> <p>E-Mail: mossa.rod@t-online.de</p> <p>Should service be required, contact the dealer in the country of purchase.</p>
--	--

Copyright 2003 CAS Medical Systems, Inc.

All rights reserved. No part of this manual may be reproduced without the written permission of CAS Medical Systems, Inc. CAS reserves the right to make changes to this manual and improvements to the product it describes at any time without notice or obligation.

This page is intentionally left blank

TABLE OF CONTENTS

1. INTRODUCTION AND INTENDED USE.....	21
INTRODUCTION	21
INDICATIONS FOR USE.....	21
CONTRAINDICATIONS	21
BRIEF DEVICE DESCRIPTION	21
PATIENT ENVIRONMENT	23
DEFINITION OF TERMS.....	24
2. UNPACKING THE MONITOR.....	27
INITIAL INSPECTION.....	27
MONITOR CHECKLIST.....	27
OPTIONAL MOUNTING ACCESSORIES.....	28
3. SYMBOLS.....	31
4. SAFETY MEASURES AND WARNINGS.....	39
AUTOMATIC SAFETY FEATURES	43
5. BLOOD PRESSURE MONITORING.....	47
CUFF SELECTION AND APPLICATION	47
NIBP HOSES	49
6. PULSE OXIMETRY MONITORING.....	53
TAKING A SpO ₂ MEASUREMENT	53
FINGER CLIP SENSORS.....	53
DISPOSABLE FLEX - TYPE SENSORS	54
MASIMO® OXIMETER (if so equipped).....	55
ATTACHING THE CABLES	55
REMOVING THE INTERFACE CABLE	56
MASIMO MESSAGES	56
NELLCOR® OXIMETER (if so equipped)	57
ATTACHMENT PROCEDURE	57
REMOVING THE INTERFACE CABLE	57
NONIN® OXIMETER (if so equipped).....	58
ATTACHING THE SENSOR CABLE	58
REMOVING THE SENSOR CABLE.....	58
7. TEMPERATURE MONITORING.....	61
WELCH ALLYN TEMPERATURE.....	61
TAKING AN ORAL TEMPERATURE	61
TAKING A RECTAL TEMPERATURE	63
TAKING AN AXILLARY TEMPERATURE.....	65
INSERTING & REMOVING PROBE WELL (SureTemp Plus® Only)	67

8. MONITOR OPERATION	71
FRONT PANEL	71
DIGITAL DISPLAY AND INDICATORS	72
FRONT PANEL CONTROLS	74
INFRARED (Ir) DATA PORT	77
REAR PANEL	78
AC / DC CONNECTION	79
FUSE COMPARTMENT	79
BATTERY COMPARTMENT	79
TEMPERATURE PROBE ELECTRICAL CONNECTION	79
EQUIPOTENTIALITY GROUND POST	80
EXTERNAL DEVICE INTERFACE	80
LEFT SIDE VIEW	80
CUFF HOSE CONNECTION	81
SpO ₂ SENSOR CONNECTION	81
RIGHT SIDE VIEW	82
TEMPERATURE HOLDER	82
MONITOR OPERATING INSTRUCTIONS	83
ADULT/ NEONATE OPERATING MODE	83
TURNING THE CASMED 740 MONITOR "ON"	83
FRONT PANEL INTENSITY CONTROL	85
DISPLAYING THE TIME	85
MANUAL MODE FOR BLOOD PRESSURE DETERMINATION	85
AUTOMATIC CYCLE FOR BLOOD PRESSURE DETERMINATION	87
STAT MODE	87
HISTORY MODES	88
EVENT HISTORY (EVENT-Ev)	89
TREND HISTORY (TREND-Tr)	90
PRINT HISTORY	90
CLEARING HISTORY	91
REAL TIME CLOCK (RTC)	91
PATIENT ALARM MODE	91
CHANGING ALARM LIMITS	92
SAVING ALARM LIMITS	92
RESTORE FACTORY DEFAULTS	92
ALARM LIMIT VALUES	93
AUDIBLE AND VISUAL INDICATORS	94
CLEARING ALARMS	95
NIBP PATIENT ALARMS	95
HIGH / LOW %SpO ₂ ALARMS	95
SpO ₂ PULSE RATE ALARM	95
EQUIPMENT ALARMS	96
ADJUSTING THE AUDIO ALARM VOLUME	96
ADJUSTING THE SpO ₂ "BEEP" VOLUME	96
2-MINUTE AUDIO SILENCE	96
PERMANENT AUDIO ALARM SILENCE	97
ALARM LIMITS OFF	98

MONITOR CONFIGURATION	98
ENTERING THE CONFIGURATION MENU.....	98
SAVING YOUR CHANGES.....	99
SOFTWARE REVISIONS	99
SELECTING THE LANGUAGE.....	100
SELECTING THE PATIENT MODE.....	100
SELECTING THE POWER-OFF DELAY TIME	101
SELECTING THE TEMPERATURE SCALE.....	101
AUDIO ALARM SILENCE (SILENCE/RESET Pushbutton).....	101
2-MINUTE AUDIO ALARM SILENCE.....	102
PERMANENT AUDIO ALARM SILENCE.....	102
ALARM LIMITS OFF	102
MAP VALUE ENABLE / DISABLE.....	103
SET THE SpO ₂ ALARM DELAY.....	103
SETTING THE DATE	104
SETTING THE TIME	104
DAYLIGHT SAVING TIME OPTION.....	105
BATTERY POWER.....	105
CHECKING BATTERY STATUS.....	107
AUTO OFF FEATURE.....	108
POWER FAIL.....	108
USER MESSAGES.....	108
SpO ₂ USER MESSAGES	109
TEMPERATURE FUNCTION USER MESSAGES.....	110
ERROR MESSAGES ON THE MESSAGE WINDOW	113
9. EXTERNAL PRINTER.....	119
PRINTER OVERVIEW	119
PRINTER CONTROLS AND INDICATORS.....	120
PRINTER OPERATION.....	121
DIRECT CONNECTION.....	121
INFRARED CONNECTION.....	121
CHARGING THE PRINTER BATTERY	123
INSTALLING PAPER.....	123
REPLACING THE BATTERY PACK.....	124
INSTALLING A NEW BATTERY PACK.....	125
10. CLEANING.....	129
CLEANING OVERVIEW	129
THE MONITOR.....	129
THE DISPLAY.....	130
CUFFS.....	130
TUFF-CUFF	130
SAFE-CUFF	130
SOFTCHECK.....	130
ULTRACHECK.....	130
PNEUMATIC TUBING.....	131
PRINTER	131

CASMED 740 Monitors

SpO ₂ INTERCONNECT CABLE.....	131
SpO ₂ SENSORS.....	131
TEMPERATURE PROBES	132
PROBE WELL (SureTemp Plus).....	132
11. MAINTENANCE	135
MAINTENANCE INTERVALS	135
TEST MODE	135
ENTER THE TEST MODE	135
EXIT THE TEST MODE.....	136
LED CHECK	136
CALIBRATION CHECK	136
SYSTEM PRESSURE	136
OVERPRESSURE.....	137
PNEUMATIC PRESSURE CHECKS	137
TEMPERATURE CALIBRATION CHECK.....	139
OXIMETRY CALIBRATION CHECK	140
REPLACING THE MONITOR BATTERY.....	140
REMOVING THE BATTERY	140
INSTALLING THE BATTERY.....	141
CHANGING THE FUSES	141
STORAGE	142
12. EXTERNAL DEVICE INTERFACING.....	145
OVERVIEW.....	145
RS232	145
NURSE CALL INTERFACE.....	145
13. ACCESSORIES	149
BLOOD PRESSURE CUFFS	149
Tuff-Cuff®	149
UltraCheck®.....	149
Safe-Cuff™	150
INFLATION HOSES	150
OXIMETRY	150
Masimo.....	150
Nellcor.....	151
Nonin.....	151
TEMPERATURE.....	152
Welch Allyn	152
OTHER ACCESSORIES	152
MONITOR CONFIGURATIONS	153
14. GLOSSARY	157
15. SPECIFICATIONS	161
16. PURCHASING RECORD	169

FIGURES

Figure 1: Patient Environment	23
Figure 2: Cuff Application	47
Figure 3: Cuff Positioning	48
Figure 4: SpO₂ Finger Clip Sensor Application	53
Figure 5: Flex – Type Adult Application	54
Figure 6: Flex V – Type Infant Application	54
Figure 7: Flex – Type Neonatal Application	54
Figure 8: Loading the Probe Cover	61
Figure 9: Location of Sublingual Pockets	62
Figure 10: Loading the Probe Cover	64
Figure 11: Loading the Probe Cover	66
Figure 12: Inserting & Removing the Probe Well	68
Figure 13: Front Panel Views	71
Figure 14: Front Panel Controls	74
Figure 15: 740 Rear Panel View	78
Figure 16: 740M Rear Panel View	79
Figure 17: Left Side Panel Views	80
Figure 18: Right Side Panel View	82
Figure 19: Turning the Monitor On	83
Figure 20: Printer Controls and Indicators	120
Figure 21: Sample Printouts	122
Figure 22: Paper Installation	123
Figure 23: Opening the Battery Door	124
Figure 24: Installing the New Battery	125
Figure 25: Removing the Monitor Battery Pack	140
Figure 26: DB9 Male Connector Pin Layout	146

TABLES

Table 1: Parts of the System	23
Table 2: Selectable Initial Inflation Pressures	85
Table 3: Default Alarm Values	93
Table 4: Audible and Visual Indicators	94
Table 5: Software Revisions	99
Table 6: SureTemp® Temperature Error Codes	111
Table 7: SureTemp Plus® Temperature Error Codes	112
Table 8: Error Messages on the Message Window	113
Table 9: DB9 Pin Out	146
Table 10: Monitor Configurations	153

Section 1

Introduction and Intended Use

1. INTRODUCTION AND INTENDED USE

INTRODUCTION

The CASMED 740 Monitor is a multi parameter monitor measuring blood pressure, oxygen saturation and temperature. Non-invasive blood pressure is measured using the oscillometric technique determining systolic, diastolic, mean arterial pressure and pulse rate. The pulse oximeter function continuously monitors and displays values for functional arterial hemoglobin saturation and a pulse rate. Temperature is obtained in the normal (predictive) mode in as little as four (4) seconds. A monitoring mode is available for taking axillary temperatures.

INDICATIONS FOR USE

The CASMED 740 Series Vital Signs Monitor is indicated for use for non-invasive monitoring of blood pressure, oxygen saturation, pulse and temperature of adult, pediatric and neonatal patients, in the care of health professionals.

WARNING:

The CASMED 740 Monitor is intended only as an adjunct in patient assessment. It must be used in conjunction with clinical signs and symptoms.

CONTRAINDICATIONS

- Oral and Rectal Temperature measurements are not intended for neonatal use.
- Reusable SpO₂ sensors are contraindicated for use for prolonged periods of use. They are not intended for long term monitoring. They must be removed and repositioned every four (4) hours and if indicated by circulatory condition or skin integrity, reapplied to a different monitoring site.
- Disposable SpO₂ sensors are contraindicated for patients that exhibit allergic reactions to adhesive tape. The sensors must be removed and repositioned every eight (8) hours and if indicated by circulatory condition or skin integrity, reapplied to a different monitoring site.
- No other contraindications are known at this time.

BRIEF DEVICE DESCRIPTION

The CASMED 740 Monitor is compact, lightweight and portable, allowing it to be easily carried and used in a variety of clinical settings. The monitor is powered by AC Line Power, +12 VDC or by a Nickel Metal Hydride (NiMH) rechargeable battery pack. The internal battery pack charges when the monitor is plugged into a power source (AC Line Power or +12 VDC). The CASMED 740 Monitor can be set to operate in one of nine (9) different languages: English, German, French, Italian, Spanish, Dutch, Swedish, Portuguese or Norwegian. The message window can display various system alarm messages. These messages direct the user to check conditions such as the battery state, air leaks and measurement problems. The message window also displays the operational mode of the monitor (automatic or manual).

CASMED 740 Monitors

The non-invasive blood pressure (NIBP) parameter automatically inflates an occluding cuff and, using the oscillometric measurement technique, determines systolic, diastolic and mean arterial pressure and pulse rate. Measurement results along with operator prompts and error messages are displayed on the front panel. The frequency of NIBP determination can be selected by the operator in varied times between one and ninety minutes. The auto and manual operating modes cover a variety of clinical uses.

The pulse oximeter parameter (%SpO₂) determines arterial oxyhemoglobin saturation by measuring the absorption of red and infrared light passing through the tissue. Changes in absorption caused by pulsations of blood in the vascular bed are used to determine arterial saturation and pulse rate. The oximeter requires no routine calibration or maintenance. Oxygen saturation and heart rate are displayed on light emitting diode (LED) digital displays. On each detected pulse, the perfusion LED does indicate patient perfusion signals. This bar graph gives the user a pulse-by-pulse visual indication of waveform signal quality. An audio “beep” can be enabled that is generated each time the SpO₂ module detects a pulse.

NOTE:

The bar graph is not proportional to the pulse volume.

The temperature parameter has the capability of taking temperature in either normal (predictive) or monitor mode. In the normal mode, the thermometer’s microprocessor “predicts” body temperature in about four (4) seconds for oral temperatures, about ten (10) seconds for axillary temperatures and in about fifteen (15) seconds for rectal temperatures.

Monitor mode is normally used for longer term monitoring and when difficult situations prevent accurate temperature from being taken in the predictive mode. In monitoring mode, the probe must be in contact with tissue for at least three (3) minutes for accurate oral / rectal temperature measurement and five (5) minutes for accurate axillary temperature measurement.

The default setting used by the CASMED 740 Monitor for temperature determinations is the normal (predictive) mode.

NOTE:

Axillary temperature readings may only be taken in the Neonate monitoring mode.

PATIENT ENVIRONMENT

The CASMED 740 Monitor has been tested with specific parts of the “system” used within the Patient Environment. Figure 1, defines the Patient Environment.

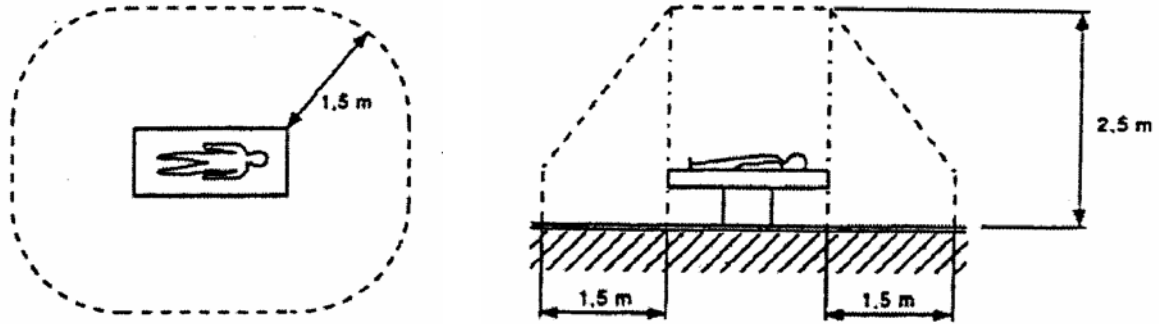

Figure 1: Patient Environment

The parts of the CASMED 740 Monitor “system” that can be used in the Patient Environment are defined as;

The CASMED 740 Monitor
Appropriate Accessories, listed in the ACCESSORIES section of this User’s Manual
Line Cord
RS232 Interface
Citizen CMP-10 Mobile Printer
RS232 Interconnect Cable (supplied with printer)
AC Adapter / Charger, Model TRC-09-1100-M from Group West or equivalent (supplied with printer)

Table 1: Parts of the System

CASMED 740 Monitors

DEFINITION OF TERMS

In this manual, “WARNING”, “CAUTION”, “IMPORTANT” and “NOTE” mean the following:

WARNING:

Directions that warn of conditions that put the patient or caregiver at risk.

CAUTION:

Directions that help you avoid damaging your monitor or losing data.

IMPORTANT:

Directions you should be particularly aware of; something not readily apparent.

NOTE:

Directions that make it easier to use your monitor.

Section 2

Unpacking the Monitor

2. UNPACKING THE MONITOR

INITIAL INSPECTION

Before unpacking the monitor, inspect the packaging for damage. If there are any signs of damage to the package, a claim should be filed immediately with the shipping agent. It is the receiver's responsibility to notify the carrier's local office to arrange for the pickup of the damaged items. Save the damaged shipping carton as evidence.

Contact your distributor, CAS sales representative, or call CAS Medical Systems, Inc. to report external damage and to arrange for repair or replacement of damaged equipment.

The shipping carton should contain the items listed below. Unpack the monitor and account for each item. Inspect each item for signs of external damage, dents, cracks, scratches, etc. If an item is missing or damaged, contact your distributor, CAS sales representative, or CAS Medical Systems, Inc.

Record the monitor model, serial number and date of purchase at the back of this manual.

MONITOR CHECKLIST

Qty	Description
1	CASMED 740 Monitor
1	AC Power Cord or DC Power Cord – depending on model purchased
1	Ten (10) Foot Coiled Inflation Hose
1	Blood Pressure Cuffs, Adult
1	Blood Pressure Cuffs, Child
1	SpO ₂ Interconnect Cable - For models with SpO ₂ installed.(*)
1	SpO ₂ Finger Sensor - For models with SpO ₂ installed.(*)
1	SureTemp Plus® Oral Probe and a box of Probe Covers - For models with Temperature installed.
1	P9 Calibration Kit (includes T - connector with tubing and male luer plug)
1	CASMED 740 Monitor User's Manual

(*) CASMED 740 Monitors configured with Nonin SpO₂, ship with a 2-meter sensor/cable assembly.

NOTE:

The monitor is shipped with the appropriate line cord for the country and or voltage being used.

CASMED 740 Monitors

OPTIONAL MOUNTING ACCESSORIES

The CASMED 740 Monitor is available with several mounting configurations to fit your needs. They consist of:

Swiveled Hard Mount
Carrying Case

GCX Roll Stand and Basket
Universal Mount

Refer to Section 13, ACCESSORIES for part number information. Contact CAS Medical Systems' Customer Service Department or your local distributor for more information.

Section 3

Symbols

3. SYMBOLS

The following is a summary of all symbols used on the monitor and accessories. Symbols may occur on the product or on its packaging.

Units may display the following symbols:



Alternating Current



CAUTION: Before using, read instructions included.



The CE Mark and Notified Body Registration Number signify the device has met all essential requirements of European Medical Device Directive 93/42/EEC.



This symbol appears here instead of on the unit.
The first two digits of the unit's serial number indicate the year of manufacture in the 21st century.



Indicates this monitor is subject to the Waste Electrical and Electronic Equipment Directive in the European Union.



Medical Electrical Equipment Classification
Class II device (if applicable)



The CASMED 740 Monitor is normally a Class I device.

The CASMED 740 Monitor becomes a Class II device when it is mounted and connected to a DC power source (740M).

CASMED 740 Monitors

SYMBOLS (CONT.)

IPX1

Protection against ingress of water.



Symbol used on the rear panel of the CASMED 740M, to indicate the polarity of the DC power input.



Direct Current



Indicates protection against the effects of the discharge of a cardiac defibrillator. Patient connections are Type BF and protected against defibrillation.



Equipotentiality Ground Post



NIBP Hose and Cuff Connector

SpO₂

Pulse Oximeter Probe Input Connector

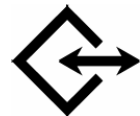

Two-way Communication Port
RS232 and Nurse Call Interface Connector



Temperature Probe Input Connector

SYMBOLS (CONT.)

These symbols appear on the front panel in place of text.



ON/STANDBY – Turns “ON” the Monitor’s display.



SILENCE/RESET



START/STAT

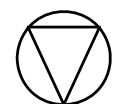

CANCEL



CYCLE TIME

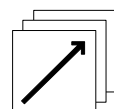

HISTORY

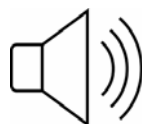

VOLUME



ALARM LIMITS

CASMED 740 Monitors

SYMBOLS (CONT.)



ARROW UP



ARROW DOWN



Bar graph display of SpO₂ signal strength.



Pulse Rate Display

ADULT

A lighted LED used to indicate NIBP operating in Adult Mode.

NEO

A lighted LED used to indicate NIBP operating in Neonatal Mode.

TEMP

A lighted LED used to indicate the Temperature Option is installed.

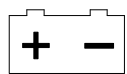

A tri-colored LED used to indicate the status of the monitors power source.

SYMBOLS (CONT.)

These symbols appear on the battery pack in place of text.



Recycling suggested (see General Notes).

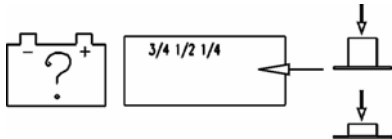

Located on the Smart Pack batteries, a set of four (4) LEDs used to indicate the approximate amount of charge remaining in the battery pack. See Page 107, CHECKING BATTERY STATUS for more information.

These symbols appear on the packaging in place of text.



Lot Number



Symbol used to indicate where Relative Humidity information concerning storage and transport can be located.



Single Patient Use. Do Not Reuse.



Symbol used to indicate the minimum and maximum storage and transport Temperatures.



Use By date (yyyy-mm)

CASMED 740 Monitors

SYMBOLS (CONT.)

This symbol appears on the printer in place of text.



WARNING: Before removing, read instructions in Section 9.

Section 4

Safety Measures, Warnings and Precautions

4. SAFETY MEASURES AND WARNINGS

WARNING:

Do not use this instrument for any purpose other than specified in this manual. Doing so will invalidate the monitor's warranty.

Do not connect more than one (1) patient to the monitor.

Do not plug the monitor into an outlet controlled by a wall switch.

Before each use, verify that the alarm limits are appropriate for the patient being monitored.

The position of subject, physiological condition and other factors affect the readings.

Blood pressure and pulse can fluctuate greatly between measurements; the monitor cannot alert the user to changes in vital signs occurring between measurement cycles.

Occasionally, electrical signals at the heart do not produce a peripheral pulse. If a patient's beat-to-beat pulse amplitude varies significantly (for example, pulsus alternans, atrial fibrillation, rapid-cycling artificial ventilator), blood pressure and pulse rate readings can be erratic and an alternate measuring method should be used for confirmation.

Where the integrity of the external protective conductor in the installation or its arrangement is in doubt, EQUIPMENT shall be operated from its INTERNAL ELECTRICAL POWER SOURCE.

Isolation of product from mains can only be achieved by removal of external power cord.

Do not, under any circumstances, perform any testing or maintenance on the monitor or power cord while the unit is being used to monitor a patient. Unplug the power cord before cleaning or servicing the monitor. The operator should not perform any servicing except as specifically stated in this manual.

Do not touch part of non-medical electrical equipment in the patient environment after removal of covers, connectors etc... without the use of a tool which operate at voltages not exceeding 25 VAC or 60 VDC and the patient at the same time.

Do not use a frayed or damaged power cord, or any accessory if you notice any sign of damage. Contact CAS Medical Systems for assistance.

The use of Accessory equipment not complying with the equivalent safety requirements of this equipment may lead to a reduced level of safety of the resulting system. Consideration relating to the choice shall include:

- Use of the accessory in the Patient Environment.
- Evidence that the safety certification of the accessory has been performed in accordance with the appropriate IEC 60601-1 and/or IEC 60601-1-1 harmonized national standard.

Equipment not suitable for use in the presence of FLAMMABLE ANESTHETICS.

Equipment is not intended to be used in Oxygen Enriched Atmospheres.

CASMED 740 Monitors

WARNING:

Do not gas sterilize or autoclave the monitor.

Do not use the monitor in the presence of Magnetic Resonance Imaging (MRI) equipment.

Do not apply the blood pressure cuff on an extremity being used for an intravenous infusion.

Do not place liquids on top of the monitor. Do not immerse the monitor or power cord in water or any liquid. If unit is accidentally wetted it should be thoroughly dried. The rear cover can be removed by a qualified service technician to verify absence of water.

During use and testing, single-use disposable temperature probe covers will limit patient cross-contamination and ensure the safety of the patient, user and device. The use of any other probe covers or failure to use a probe cover may produce temperature errors and will invalidate the monitor's warranty.

A pulse oximeter should be considered an early warning device. As a trend toward patient deoxygenation is indicated, blood samples should be analyzed by a laboratory co-oximeter to completely understand the patient's condition.

Accurate oxygen saturation measurements cannot be obtained when the oximeter is not measuring the pulse properly. If the perfusion LED is erratic or the Pulse Rate display is erratic or inaccurate, first examine the patient for any sign of distress and only then re-examine sensor placement.

ACCURACY – If the accuracy of any measurement does not seem reasonable, first check the patient's vital signs by alternate means and then check the CASMED 740 Monitor for proper functioning.

CABLES – Route all cables away from patient's throat to avoid possible strangulation.

DEFIBRILLATION – Do not come in contact with patients during defibrillation. Serious injury or death could result.

DISPOSAL – Dispose of the packaging material, observing the applicable waste control regulations.

LEAKAGE CURRENT TEST – The interconnection of auxiliary equipment, including a patient monitor or other patient equipment, with this device may increase the total leakage current. When interfacing with other equipment, a test for leakage current must be performed by a qualified biomedical engineering personnel before using with patients. Serious injury or death could result if the leakage current exceeds applicable standards.

SITE REQUIREMENTS – For safety reasons, all connectors for patient cables and sensor leads are designed to prevent inadvertent disconnection, should someone pull on them. Do not route cables in a way that they may present a stumbling hazard. For devices installed above the patient, adequate precautions must be taken to prevent them from dropping on the patient.

CAUTION:

Before each use, make sure that the monitor default alarm settings are appropriate for the specific patient being monitored.

Pressing the front panel keyswitch with a sharp or pointed instrument may permanently damage the keyswitch. Press the keyswitch using only your finger.

Do not operate the monitor unless it has been properly calibrated. Inaccurate blood pressure readings may result. A calibration check is recommended once every year. A pneumatic check is recommended once every six (6) months.

As with any non-invasive oscillometric blood pressure monitor, the accuracy of the measurements obtained may be adversely affected by the presence of agents that alter the patient's cardiovascular system.

Do not alter the monitor's air hose. CAS Medical Systems cannot ensure proper monitor performance if the tubing is altered. Modification of the air hose will void the warranty. Avoid compression or restriction of pressure tubes.

A NIBP monitor does not operate effectively if a patient is having seizure activity, convulsions or tremors or is connected to a heart/lung machine.

In shock conditions, the low amplitude of the blood pressure waveform may make it difficult for the monitor to accurately determine the systolic and diastolic pressures.

When a patient is experiencing arrhythmias during a NIBP measurement, the accuracy of the pulse determination may be affected or the time needed to complete a measurement may be extended. The monitor will not make a determination beyond 120 seconds.

If the cuff is applied on a limb being used for oxygen saturation monitoring %SpO₂ results will be altered during each blood pressure measurement due to the occlusion of blood flow.

Inspect the monitor, air hose and sensors for any damage prior to operation. If any damage is noted, the monitor should not be used until it has been serviced. The monitor should be repaired only by personnel authorized to do so by CAS Medical Systems, Inc.

Use only CAS Medical Systems approved accessories and sensors to preserve the integrity, accuracy and the electromagnetic compatibility of the monitor.

Consult a physician for interpretation of blood pressure measurements.

The oximeter is factory calibrated to determine the percentage of arterial oxygen saturation of functional hemoglobin.

Significant levels of dysfunctional hemoglobins such as carboxyhemoglobin or methemoglobin may affect the accuracy of the measurement.

Cardiogreen and other intravascular dyes, depending on the concentration, may affect the accuracy of the oximeter measurement.

CASMED 740 Monitors

CAUTION:

Some sensors may not be appropriate for a particular patient. If at least ten (10) seconds of one bar pulses cannot be observed for a given sensor, change sensor location or sensor type until this condition is achieved.

If the monitor fails to respond, do not use it until the situation has been corrected by qualified personnel.

Biting the probe tip while taking a temperature may result in damage to the probe.

ACCIDENTAL SPILLS – In the event that fluids are accidentally spilled on the monitor, take the monitor out of operation and inspect for damage.

BATTERY POWER – If the monitor will not be used or not connected to AC line power for a period over six (6) months, remove the battery.

ELECTRICAL SHOCK – To reduce the risk of electrical shock, do not remove the back cover. Refer all servicing to qualified personnel.

ELECTROMAGNETIC COMPATIBILITY (EMC) – The equipment needs special precautions regarding EMC. Be aware that strong electromagnetic fields may interfere with monitor operation. Interference prevents the clear reception of signals by the monitor. If the hospital is close to a strong transmitter such as TV, AM, or FM radio, police or fire stations, a HAM radio operator, an airport, or cellular phone, their signals could be picked up as signals by the monitor.

ELECTROSURGERY – Measurements may be affected in the presence of strong electromagnetic sources such as electro surgery equipment.

GROUNDING – Do not defeat the three-wire grounding feature of the power cord by means of adaptors, plug modifications, or other methods. Do not use extension cords of any type. Do not connect the monitor to an electrical outlet controlled by a wall switch or dimmer.

INTERFACING OTHER EQUIPMENT – Monitoring equipment must be interfaced with other types of medical equipment by qualified biomedical engineering personnel. Be certain to consult manufacturers' specifications to maintain safe operation.

STACKING – Where monitor is used adjacent to or stacked with other equipment, the monitor should be observed to verify normal operation in the configuration in which it will be used.

GENERAL NOTES:

There are no known risks with common disposal of equipment or accessories; however, the disposing of accessories should follow in accordance with local hospital policies. The user should ensure these policies do not conflict with any local, state or federal guidelines.

The monitor is suitable for use in the presence of electro surgery.

The monitor is suitable to be connected to public AC mains power.

The CASMED 740 Monitor is not "Category AP or APG Equipment".

The CASMED 740 Monitor is for "Continuous Operation".

The CASMED 740 Monitor applied parts are "Type BF Defibrillation Proof".

The CASMED 740 Monitor provides "DRIP-PROOF" level of protection from ingress to moisture. Do not expose the CASMED 740 Monitor to extreme moisture levels such as direct exposure to rain. Exposure to extreme moisture levels may cause incorrect or inaccurate performance or device failure during or after exposure.

AUTOMATIC SAFETY FEATURES

The monitor has been designed to promote patient safety. The maximum amount of time allowed to complete a blood pressure measurement is 120 seconds in adult mode and 90 seconds in neonate mode. If the measurement has not been completed within that time, the cuff is deflated automatically and a message is displayed indicating the problem.

To prevent exposure of the extremity to an inordinately high pressure, the cuff is deflated automatically when the pressure in the system is greater than 290 mmHg in the adult mode or 145 mmHg in the neonatal mode.

The cuffs used by the CASMED 740 Monitor are designed without transducers for patient safety. The transducers used for NIBP measurement are located inside the monitor on the NIBP board and are isolated from the patient.

In the event of a microprocessor failure, the cuff will be deflated automatically within ten (10) seconds.

All equipment parts are protected against the effects of the discharge of a defibrillator. No separate actions are required when using this equipment with a defibrillator.

Should the AC or DC power be interrupted coming into the monitor, the monitor automatically runs off battery power. An indication of this would be a change in color of the Battery Power Visual Indicator LED from Green to either Orange or Red.

CASMED 740 Monitors

Whenever the power is disconnected from the monitor and the monitor is not allowed to shut down in an orderly fashion, the monitor, when re-powered alerts the user. Refer to Page 108, POWER FAIL for more information.

CAUTION:

Regardless of these safety features, always be sure to check that there are no signs of prolonged impairment of patient circulation and that the monitor is functioning properly.

Section 5

Blood Pressure Monitoring

5. BLOOD PRESSURE MONITORING

CUFF SELECTION AND APPLICATION

The use of properly designed and sized cuffs is essential for the accurate measurement of blood pressure. SoftCheck® and Safe-Cuff™ single patient use cuffs or Tuff-Cuff® and UltraCheck® reusable cuffs are recommended for use with the CASMED 740 Monitor.

NOTE:

CAS recommends the use of its reusable, disposable and neonatal cuffs with the CASMED 740 Monitor.

CAS recommends the use of the inflation hose supplied with the monitor or a replacement from CAS.

The widest cuff that can be placed around the upper arm or thigh should be used. A cuff that is too small for the arm will not supply sufficient pressure to the artery. This can cause an erroneously high blood pressure reading. Substitution of a cuff different from that supplied might result in a measurement error.

NOTE:

Overlapping the cuff will not affect the measurement results.

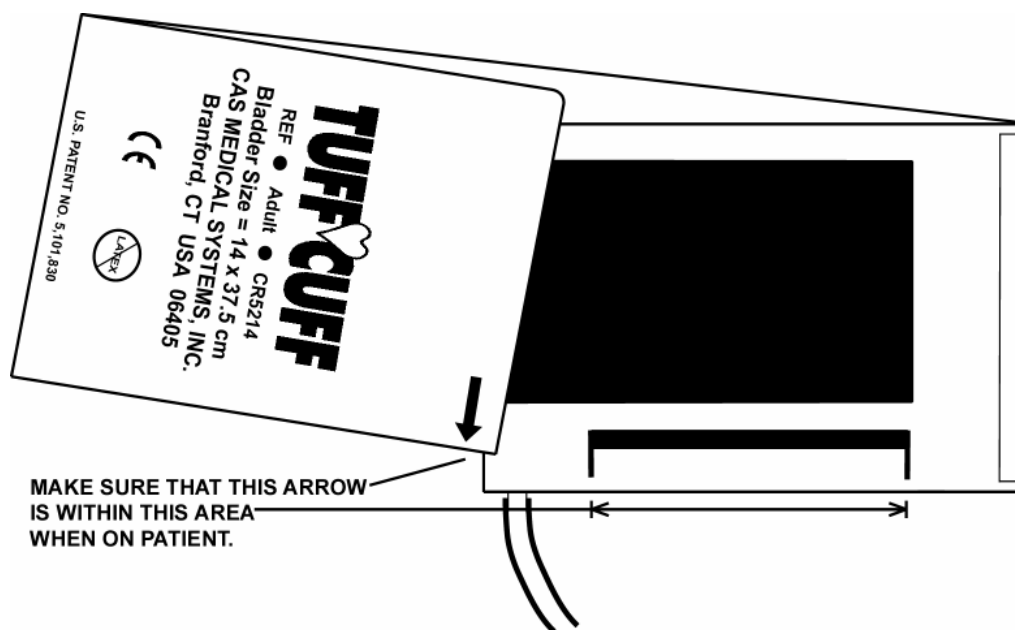

Figure 2: Cuff Application

As an example, the end of the Tuff-Cuff is marked with a white arrow. To insure that the proper cuff size has been selected, wrap the cuff around the patient's extremity, the marker should fall between the white markings on the cuff.

CASMED 740 Monitors

Measurements made above the level of the heart will give reduced blood pressure readings while measurements made below the heart level will give increased readings. These errors are mainly due to the weight of the blood.

The following guidelines should be observed;

- When applying the cuff, make sure the cuff tubing is centered over the brachial artery.
- Wrap the cuff for a snug fit to avoid prolonged pumping time. Do not wrap a cuff over the patient's clothing.
- Verify the hook and loop sections of the cuff are fully engaged when it is wrapped around the limb.
- The limb should be positioned to be at heart level.
- Do not compress the cuff or the cuff hose. The hose must not be kinked or pinched.

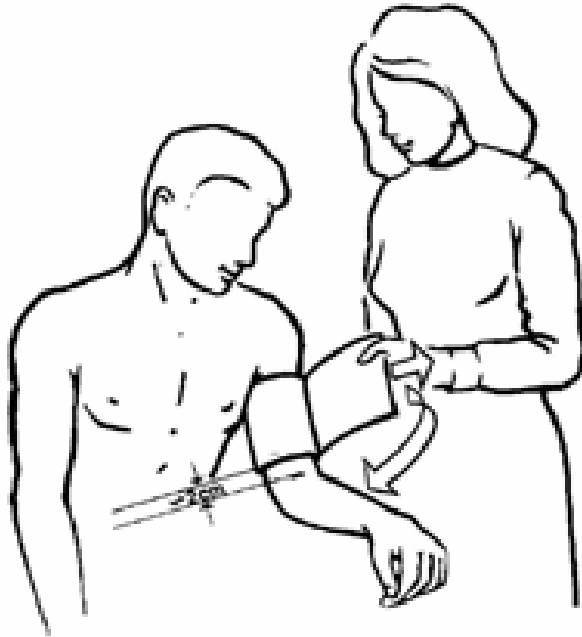

Figure 3: **Cuff Positioning**

NOTE:

Remember that there may be a marked difference between readings taken from the left and the right arms. Be consistent with each patient.

WARNING:

The cuff should not be applied on a limb being used for an intravenous infusion. Do not place the cuff on any extremity being used for SpO₂ monitoring.

WARNING:

When monitoring over an extended period of time, or at frequent intervals, periodically observe the patient's limb to make sure that the circulation is not impaired for a prolonged period of time.

NIBP HOSES

CAS Medical offers two (2) NIBP Inflation Hoses.

For Adult and Pediatric patient monitoring using the ADULT NIBP mode and Cuffs, the coiled ten (10) foot NIBP hose (CAS p/n 01-02-0131) is recommended.

For Neonatal and Infant patient monitoring using the NEO NIBP mode and Neonatal cuffs, the Neonatal six (6) foot NIBP hose (CAS p/n 01-02-0185) is recommended.

NOTE:

Avoid compression or restriction of NIBP hoses.

See Section 13, ACCESSORIES for CAS Medical Systems part number information.

This page is intentionally left blank

Section 6

Pulse Oximetry Monitoring

6. PULSE OXIMETRY MONITORING

The CASMED 740 Monitor features a wide variety of SpO₂ technology that is ideal for every application.

TAKING A SpO₂ MEASUREMENT

IMPORTANT:

Prior to patient monitoring, ensure the monitor is configured to the appropriate patient mode – Neonate or Adult.

The following is a general procedure for taking a SpO₂ measurement:

- 1) Select a sensor based on the patient size and monitoring conditions and properly attach the sensor to the patient.

FINGER CLIP SENSORS

The finger clip sensor is designed for spot check monitoring of pediatric and adult patients or continuous monitoring where patient movement is not expected, and the patient's finger is large enough for the sensor to be attached securely.

NOTE:

If patient movement is occurring or the finger size is inappropriate, select a different sensor that is appropriate for the patient and the monitoring environment.

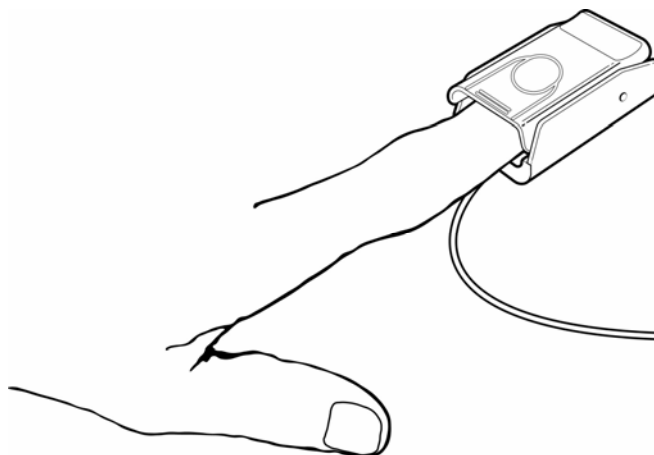

Figure 4: SpO₂ Finger Clip Sensor Application

Insert the finger (preferably left or right index finger) completely into the sensor. Place the sensor with the LEDs positioned on the nail side. The thumb is specifically not recommended for use with the finger clip sensor.

DISPOSABLE FLEX - TYPE SENSORS

These types of sensors are designed for patients as a single patient use sensor and is intended for use where moderate patient movement is expected or cross contamination is possible.



Figure 5: Flex – Type Adult Application

Adult and Pediatric: The preferred application site is the index finger, however, other fingers or toes may be used where the tissue thickness is between 5 and 17 millimeters.



Figure 6: Flex V – Type Infant Application

Infant: The preferred application site is the large toe of infants greater than 2 kilograms in weight.

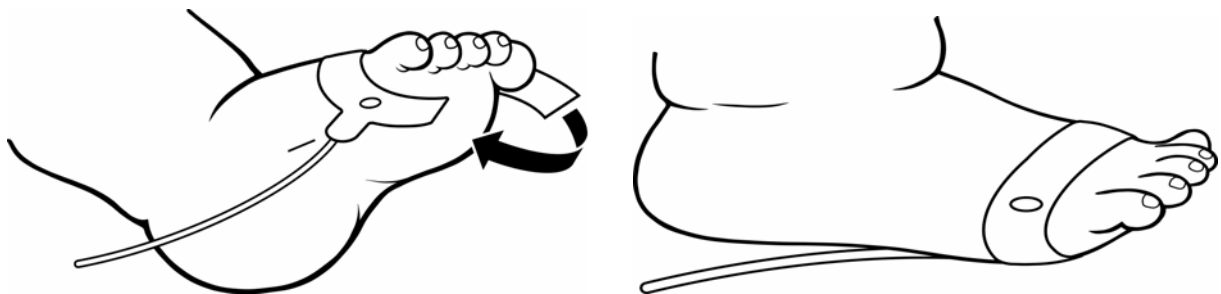

Figure 7: Flex – Type Neonatal Application

Neonatal: The preferred application site is on the foot close to the toes for infants less than 2 kilograms in weight.

NOTE:

For best results, secure the sensor cable independently from the sensor, preferably around the base of the finger. Tape may be used to secure the cable to the patient. Make sure that the tape being used does not restrict the blood flow.

- 2) Once the sensor has been attached to the patient and to the monitor, the SpO₂ signal bar graph will illuminate and indicate the relative signal strength and signal quality at the sensor site. Wait for the monitor to determine the initial %SpO₂ and Pulse Rate values. When the values have been determined, they will be displayed in their respective %SpO₂ and ♥BPM front panel LED display windows.

NOTE:

Inspect the pulse oximeter site every 2 to 4 hours or per hospital protocol. If there is any skin irritation caused by the sensor, remove the sensor and apply it to a different location.

- 3) When SpO₂ monitoring is completed, remove the sensor from the patient.

When the probe is removed from the patient, the message “Prb OFF” appears in the Message Window and an audible alarm sounds, indicating a connection has been lost.

Press the SILENCE/RESET pushbutton. The monitor silences the audible alarm tone, but the message remains.

NOTE:

If either the 2-Minute Audio Off or Permanent Audio Off is enabled, no audio will be heard but a visual message will appear in the Message Window.

MASIMO® OXIMETER (if so equipped)

The CASMED 740 Monitor can be equipped to use SpO₂ sensors manufactured by Masimo. No other manufacturer's sensors should be used.

NOTE:

CASMED 740 Monitors equipped with Masimo oximetry will have the Masimo SET® logo next to the SpO₂ connector.

ATTACHING THE CABLES

- 1) Select and apply a sensor that is the appropriate size for the patient's digit or extremity, according to the instructions provided by Masimo.
- 2) Orient the connecting tab of the sensor so that the shiny contacts are pointed up. Mate the logo on the sensor to the logo on the patient cable.
- 3) Insert the tab of the sensor into the patient cable connector until there is a tactile or audible “click” connection. Verify a secure connection and gently tug on the patient cable connector.
- 4) Plug the Interface Cable into the SpO₂ connector on the side panel of the monitor. The connector is shaped like a “D”. Line up the “D” on the Interface Cable with the “D” on the receptacle. Push the cable in until you hear an audible “click”.

CASMED 740 Monitors

- 5) Press the ON/STANDBY pushbutton to turn "ON" the monitor.
- 6) Check the Alarm Limits and configure them appropriately for the patient. Refer to Page 91, PATIENT ALARM MODE for more information.

REMOVING THE INTERFACE CABLE

When SpO₂ monitoring is not required, disconnect the Interface Cable by squeezing the grey tabs with your thumb and index finger while pulling the connector away from the monitor.

NOTE:

To avoid damage to the Interface Cable, always hold it by the connector rather than the cable when connecting or disconnecting either end.

When the probe is disconnected from the monitor, the message "No Probe" appears in the Message Window and an audible alarm sounds indicating a connection has been broken. Press the SILENCE/RESET pushbutton to silence the visual and audible alarm.

NOTE:

If either the 2-Minute Audio Off or Permanent Audio Off is enabled, no audio will be heard but a visual message will appear in the Message Window.

Refer to Section 13, ACCESSORIES for Masimo oximeter probe types and part number information. Consult instructions enclosed with each sensor for proper application.

MASIMO MESSAGES

When the message "Low Perf" or "Low Sig" appear in the Message Window, and the monitor is displaying valid %SpO₂ numerics, no audible alarm will be heard.

When the message "Low Perf" or "Low Sig" appear in the Message Window, and the monitor is not displaying valid %SpO₂ numerics, an audible alarm will be heard. Press the SILENCE/RESET pushbutton. The monitor silences the audio alarm tone, but the message remains.

NELLCOR® OXIMETER (if so equipped)

The CASMED 740 Monitor can be equipped to use Nellcor OxiMax® sensors. No other manufacturer's sensors should be used.

NOTE:

CASMED 740 Monitors equipped with Nellcor oximetry will have the Nellcor OxiMax logo next to the SpO₂ connector.

ATTACHMENT PROCEDURE

- 1) Select and apply a sensor that is the appropriate size for the patient's digit or extremity, according to the instructions provided by Nellcor.
- 2) Connect the sensor assembly to the Interface Cable:
 - a) Place the plastic hinged cover in the unlocked position (perpendicular to the connector).
 - b) Connect the sensor assembly to the Interface Cable.
 - c) Lock the plastic hinged cover to prevent accidental cable disconnection.
- 3) Plug the Interface Cable into the SpO₂ connector on the side panel of the monitor. The connector is shaped like a "D". Line up the "D" on the Interface Cable with the "D" on the receptacle. Push the cable in until you hear an audible "click".
- 4) Press the ON/STANDBY pushbutton to turn "ON" the monitor.
- 5) Check the Alarm Limits and configure them appropriately for the patient. Refer to Page 91, PATIENT ALARM MODE for more information.

REMOVING THE INTERFACE CABLE

When SpO₂ monitoring is not required, disconnect the Interface Cable by squeezing the grey tabs with your thumb and index finger while pulling the connector away from the monitor.

NOTE:

To avoid damage to the Interface Cable, always hold it by the connector rather than the cable when connecting or disconnecting either end.

When the probe is disconnected from the monitor, the message "No Probe" appears in the Message Window and an audible alarm sounds indicating a connection has been broken. Press the SILENCE/RESET pushbutton to silence the visual and audible alarm.

NOTE:

If either the 2-Minute Audio Off or Permanent Audio Off is enabled, no audio will be heard but a visual message will appear in the Message Window.

Refer to Section 13, ACCESSORIES for Nellcor oximeter probe types and part number information. Consult instructions enclosed with each sensor for proper application.

CASMED 740 Monitors

NONIN® OXIMETER (if so equipped)

The CASMED 740 Monitor can be equipped to use SpO₂ sensors manufactured by Nonin. No other manufacturer's sensors should be used.

NOTE:

CASMED 740 Monitors equipped with Nonin oximetry will have the Nonin logo next to the SpO₂ connector.

ATTACHING THE SENSOR CABLE

- 1) Select and apply a sensor that is the appropriate size for the patient's digit or extremity, according to the instructions provided by Nonin.
- 2) Plug the sensor assembly into the SpO₂ connector on the side panel of the monitor. The connector is shaped like a "D". Line up the "D" on the sensor cable with the "D" on the receptacle. Push the connector in completely.
- 3) Press the ON/STANDBY pushbutton to turn "ON" the monitor.
- 4) Check the Alarm Limits and configure them appropriately for the patient. Refer to Page 91, PATIENT ALARM MODE for more information.

REMOVING THE SENSOR CABLE

When SpO₂ monitoring is not required, disconnect the Sensor Cable by carefully removing the connector from the SpO₂ input receptacle.

NOTE:

To avoid damage to the Sensor Cable, always hold it by the connector rather than the cable when connecting or disconnecting either end.

When the probe is disconnected from the monitor, the message "No Probe" appears in the Message Window and an audible alarm sounds indicating a connection has been broken. Press the SILENCE/RESET pushbutton to silence the visual and audible alarm.

NOTE:

If either the 2-Minute Audio Off or Permanent Audio Off is enabled, no audio will be heard but a visual message will appear in the Message Window.

Refer to Section 13, ACCESSORIES for Nonin oximeter probe types and part number information. Consult instructions enclosed with each sensor for proper application.

Section 7

Temperature Monitoring

7. TEMPERATURE MONITORING

WELCH ALLYN TEMPERATURE

WARNING:

During use, single-use disposable temperature probe covers supplied by CAS Medical Systems or Welch Allyn will limit patient cross-contamination. The use of any other probe cover or the failure to use a probe cover may produce temperature errors and will invalidate the monitor's warranty. Temperature probe covers are required to ensure the safety of the patient and user.

CAUTION:

When replacing a SureTemp Plus probe, it is recommended to replace the Probe Well received with the probe. Failure to replace the Probe Well could result in patient cross contamination.

TAKING AN ORAL TEMPERATURE

CAUTION:

Never use the Temperature Probe without a probe cover. Accurate oral temperatures can only be obtained by using the *blue* temperature probe. The use of the wrong probe will produce temperature errors.

To take an oral temperature (in either Predictive or Monitor mode) follow this procedure:

- 1) Insure that the oral probe is connected to the monitor and that the probe is secured into its holder. An audible "click" should be heard when the SureTemp® probe is completely placed into its holder. The SureTemp Plus® probes will slide in and out of the Probe Well without any restrictions. The oral probe has a *blue* probe cover ejection button.
- 2) Remove the probe from the probe holder. A short self-test mode will be initiated where every LED segment in the TEMP display window are illuminated briefly. Following this self-test the display will show "OrL". The "OrL" in the TEMP display window indicates that the oral algorithm will be used to take a predictive temperature measurement.
- 3) Load a probe cover onto the probe by holding the probe collar with the thumb and forefinger, being careful not to hold or press the ejection button. Refer to Figure 8.

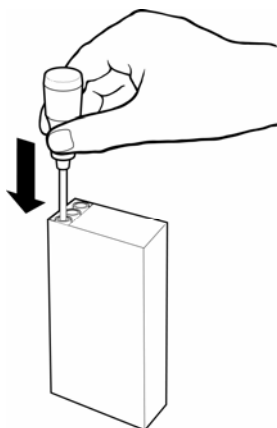

Figure 8: Loading the Probe Cover

CASMED 740 Monitors

- 4) When dashes “--” appear in the TEMP display window, the temperature sensor is ready to take a measurement. To take a normal predictive temperature, simply insert the probe tip gently into the patient’s slightly opened mouth. Carefully slide the probe under the tongue on either side of the mouth to reach the sublingual pocket. Refer to Figure 9.

To take a direct read temperature (monitor mode) wait 1 minute until a temperature value appears in the TEMP display. The decimal point associated with the temperature value will flash at a rate of one (1) second “ON” and one (1) second “OFF” as a reminder that you are in monitor mode. Insert the probe tip into the patient’s mouth as described above. The SureTemp® Plus probes will report a direct read temperature for approximately ten (10) minutes and then blank the display, even if the probe remains out of its’ well.

NOTE:

Accurate temperatures can only be obtained in this location. Temperatures in other mouth locations can vary by as much as 2°F or 1°C.

Sublingual Pockets

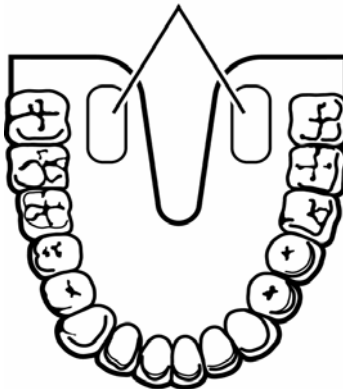

Figure 9: **Location of Sublingual Pockets**

- 5) The probe should be held by the clinician during the entire temperature measurement process to insure the probe tip maintains tissue contact.
- 6) During the predictive temperature measurement cycle, “walking” segments will appear in the TEMP display window indicating that a predictive measurement is in process.
- 7) When the final temperature has been reached, the temperature value will be displayed in the TEMP display window and an audible tone will be generated. The time of the measurement and the measured temperature will be stored in the monitor’s history memory.

NOTE:

To change the Temperature scale, refer to Page 101, **SELECTING THE TEMPERATURE SCALE.**

NOTE:

If the probe tip did not maintain tissue contact during the entire predictive measurement, the final temperature displayed in the TEMP display window will flash. If this occurs it is recommended that a new temperature be taken. Press the SILENCE/RESET pushbutton or after waiting for two (2) minutes the monitor will automatically blank the display.

- 8) After the temperature measurement is complete, remove the probe from the patient's mouth and eject the probe cover by firmly pressing the ejection button on the probe. Properly dispose of the used probe cover per protocol.
- 9) Insert the probe into the probe holder before attempting to take another temperature measurement. An audible "click" should be heard when the SureTemp® probe is completely placed into its holder. The SureTemp Plus® probes will slide in and out of the Probe Well without any restrictions.

NOTE:

Failure to correctly place the probe back into its holder may result in failure of the next predictive temperature measurement.

- 10) Following a completed temperature measurement, the current temperature measurement is displayed for five (5) minutes after which time the TEMP display will go blank.

TAKING A RECTAL TEMPERATURE

CAUTION:

Never use the Temperature Probe without a probe cover. Accurate rectal temperatures can only be obtained by using the *red* temperature probe. The use of the wrong probe will produce temperature errors.

To take a rectal temperature, follow this procedure:

- 1) Insure that the rectal probe is connected to the monitor and that the probe is secured into its holder. An audible "click" should be heard when the SureTemp probe is completely placed into its holder. The SureTemp Plus probes will slide in and out of the Probe Well without any restrictions. The rectal probe has a *red* probe cover ejection button.
- 2) Remove the probe from the probe holder. A short self-test mode will be initiated where every LED segment in the TEMP display window are illuminated briefly. Following this self-test the display will show "rEC". The "rEC" in the TEMP display window indicates that the rectal algorithm will be used to take a predictive temperature measurement.
- 3) Load a probe cover onto the probe by holding the probe collar with the thumb and forefinger, being careful not to hold or press the ejection button. Refer to Figure 10.

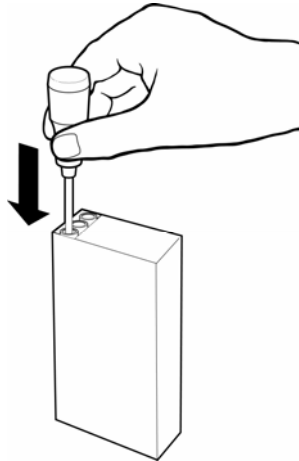

Figure 10: **Loading the Probe Cover**

- 4) When dashes “--” appear in the TEMP display window, the temperature sensor is ready to take a measurement. To take a normal predictive temperature, separate the buttocks with one hand. Apply a thin coat of water-based lubricant when necessary. Using the other hand, gently insert the probe **ONLY** 1cm (3/8 inch **ONLY**) inside the rectal sphincter.

To take a direct read temperature (monitor mode) wait 1 minute until a temperature value appears in the TEMP display. The decimal point associated with the temperature value will flash at a rate of one (1) second “ON” and one (1) second “OFF” as a reminder that you are in monitor mode. Insert the probe tip into the patient’s rectal sphincter as described above. The SureTemp® Plus probes will report a direct read temperature for approximately ten (10) minutes and then blank the display, even if the probe remains out of its’ well.

WARNING:

Extreme caution should be used to avoid risk of bowel perforation in children.

- 5) Tilt the probe to insure good tissue contact and continue to keep the buttocks separated while the measurement is in process.
- 6) During the predictive temperature measurement cycle, “walking” segments will appear in the TEMP display window indicating that a predictive measurement is in process.
- 7) When the final temperature has been reached, the temperature value will be displayed in the TEMP display window and an audible tone will be generated. The time of the measurement and the measured temperature will be stored in the monitor’s history memory.

NOTE:

To change the Temperature scale, refer to Page 101, **SELECTING THE TEMPERATURE SCALE.**

NOTE:

If the probe tip did not maintain tissue contact during the entire predictive measurement, the final temperature displayed in the TEMP display window will flash. If this occurs it is recommended that a new temperature be taken. Press the SILENCE/RESET pushbutton or after waiting for two (2) minutes the monitor will automatically blank the display.

- 8) After the temperature measurement is complete, remove the probe from the patient's rectum and eject the probe cover by firmly pressing the ejection button on the probe. Properly dispose of the used probe cover per protocol.
- 9) Insert the probe into the probe holder before attempting to take another temperature measurement. An audible "click" should be heard when the SureTemp® probe is completely placed into its holder. The SureTemp Plus® probes will slide in and out of the Probe Well without any restrictions.
- 10) Wash your hands.

NOTE:

Failure to correctly place the probe back into its holder may result in failure of the next predictive temperature measurement.

- 11) Following a completed temperature measurement, the current temperature measurement is displayed for five (5) minutes after which time the TEMP display will go blank.

TAKING AN AXILLARY TEMPERATURE

CAUTION:

Never use the Temperature Probe without a probe cover. Accurate axillary temperatures can only be obtained by using the *blue* temperature probe. The use of the wrong probe will produce temperature errors.

To take an axillary temperature in Normal (Predictive) mode follow this procedure:

- 1) Insure that the oral probe is connected to the monitor, secured into its holder and that the monitor is in NEO mode (Axillary temperatures can only be taken in NEO mode). An audible "click" should be heard when the SureTemp® probe is completely placed into its holder. The SureTemp Plus® probes will slide in and out of the Probe Well without any restrictions. The oral probe has a *blue* probe cover ejection button.
- 2) Remove the probe from the probe holder. A short self-test mode will be initiated where every LED segment in the TEMP display window are illuminated briefly. Following this self-test the display will show "ALy". The "ALy" in the TEMP display window indicates that the axillary algorithm will be used to take a predictive temperature measurement.
- 3) Load a probe cover onto the probe by holding the probe collar with the thumb and forefinger, being careful not to hold or press the ejection button. Refer to Figure 11.

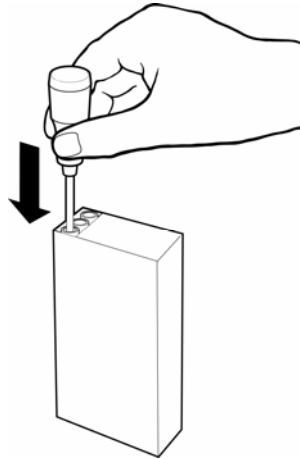

Figure 11: **Loading the Probe Cover**

When dashes “--” appear in the TEMP display window the temperature sensor is ready to take a measurement. To take a normal predictive temperature, simply place the probe as high as possible in the axilla. Do not allow the probe tip to come into contact with the patient until it is deliberately placed in the measurement site.

- 4) Be sure that the probe tip is completely surrounded by axillary tissue. Clothing or any other material touching the probe tip may cause inaccurate readings.
- 5) Place the arm close to the patient’s side. Hold the arm in this position without movement of the arm or probe during the measurement cycle.
- 6) During the predictive temperature measurement cycle, “walking” segments will appear in the TEMP display window, indicating that a predictive measurement is in process.
- 7) When the final temperature has been reached, the temperature value will be displayed in TEMP display window and an audible tone will be generated. The time of the measurement and the measured temperature will be stored in the monitor’s history memory.

NOTE:

To change the Temperature scale, refer to Page 101, SELECTING THE TEMPERATURE SCALE.

NOTE:

If the probe tip did not maintain tissue contact during the entire predictive measurement, the final temperature displayed in the TEMP display window will flash. If this occurs it is recommended that a new temperature be taken. Press the SILENCE/RESET pushbutton or after waiting for two (2) minutes the monitor will automatically blank the display.

- 8) After the temperature measurement is complete, remove the probe from the patient's axilla and eject the probe cover by firmly pressing the ejection button on the probe. Properly dispose of the used probe cover per protocol.
- 9) Insert the probe into the probe holder before attempting to take another temperature measurement. An audible "click" should be heard when the SureTemp® probe is completely placed into its holder. The SureTemp Plus® probes will slide in and out of the Probe Well without any restrictions.

NOTE:

Failure to correctly place the probe back into its holder may result in failure of the next predictive temperature measurement.

- 10) Following a completed temperature measurement, the current temperature measurement is displayed for five (5) minutes after which time the TEMP display will go blank.

INSERTING & REMOVING PROBE WELL (SureTemp Plus® Only)

CAUTION:

When replacing a SureTemp Plus probe, it is recommended to replace the Probe Well received with the probe. Failure to replace the Probe Well could result in patient cross contamination.

- 1) To insert – Position the Probe Well with the flat sides toward the front and rear of the monitor. Slide the Probe Well into the opening at the top of the Temperature module. Push the Probe well all the way down the opening. An audible "click" should be heard when the Probe Well is completely placed into its holder. Refer to Figure 12.
- 2) To remove – Grasp the Probe Well by the flared ring. Gentle pull the Probe Well straight up and continue until the Probe Well is completely out of the opening. Refer to Figure 12.

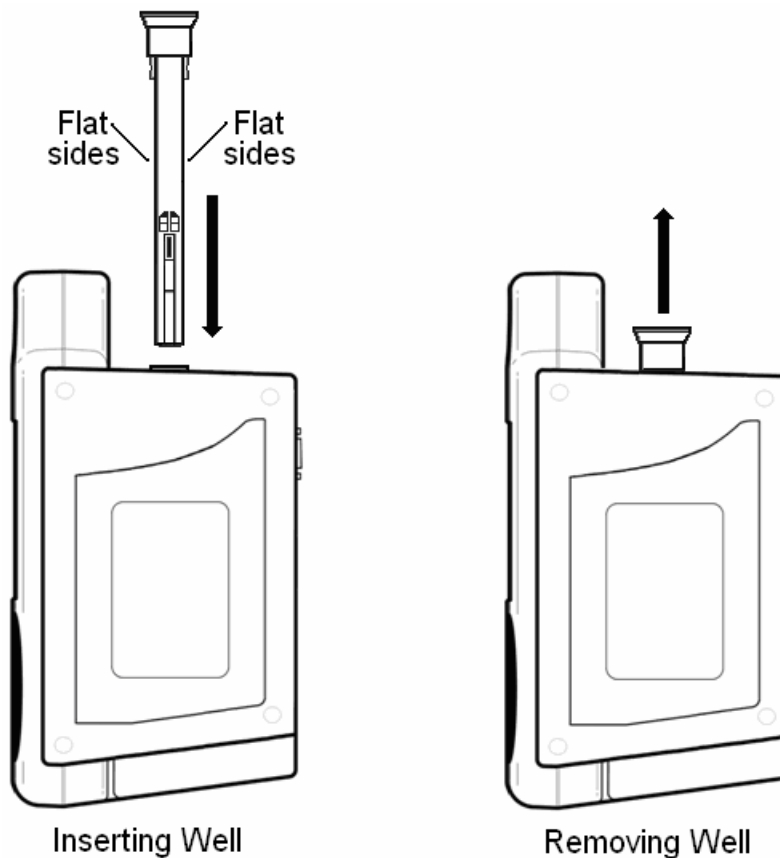

Figure 12: **Inserting & Removing the Probe Well**

CAUTION:

Never store the SureTemp Plus® Probe without a Probe Well installed in the Temperature module. Rectal probes should only be stored by using the *red* temperature Probe Wells. The rectal probe has a *red* probe cover ejection button

CAUTION:

Never store the SureTemp Plus® Probe without a Probe Well installed in the Temperature module. Oral and Axillary probes should only be stored by using the *blue* temperature Probe Wells. The oral and axillary probes has a *blue* probe cover ejection button

Refer to Section 13, ACCESSORIES for Welch Allyn temperature probe types and part number information. Consult instructions enclosed with each probe for proper application.

Section 8

Monitor Operation

8. MONITOR OPERATION

FRONT PANEL



Front Panel Keyswitch panel with English text



Front Panel Keyswitch panel, Symbols only

Figure 13: Front Panel Views

CASMED 740 Monitors

DIGITAL DISPLAY AND INDICATORS

SYSTOLIC mmHg Red colored LEDs indicate the Systolic pressure measurement in mmHg.

DIASTOLIC mmHg Red colored LEDs indicate the Diastolic pressure measurement in mmHg.

MAP mmHg Red colored LEDs indicate the Mean Arterial Pressure in mmHg (if enabled).

TEMP A Yellow LED indicator with Red colored LEDs indicates the temperature value (if installed).

% SpO₂ Green colored LEDs indicates the %SpO₂ value (if installed).

 **BPM** Red colored LEDs indicate the Pulse Rate in BPM (beats per minute).



Green colored LEDs provide a visual indication of the SpO₂ signal strength in a bar graph form (if installed).

ADULT A yellow LED indicator used to inform the user that the NIBP is operating in the Adult Mode.

NEO A yellow LED indicator used to inform the user that the NIBP is operating in the Neonatal Mode.

TEMP A yellow LED indicator used to inform the user that the Temperature Option is installed.

Ready

Message Window area used to display various messages that aid the user in monitor operation.

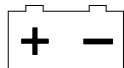

A tri-colored visual indicator used to display the status of the power source and battery condition.

The status of the LED is:

- GREEN = Monitor is connected to a main power source
- ORANGE = In Use on Battery
- RED = Battery Low or Dead Battery



A Yellow LED visual indicator used along with the SILENCE/RESET pushbutton to display the status of the Audio Alarm Silence feature. Refer to Page 96 for more information.

The status of the LED is:

- “ON” continuously = 2 Minute Audio Silence
- Flash one second “ON”/one second “OFF” = Permanent Audio Alarm Silence

CASMED 740 Monitors

FRONT PANEL CONTROLS

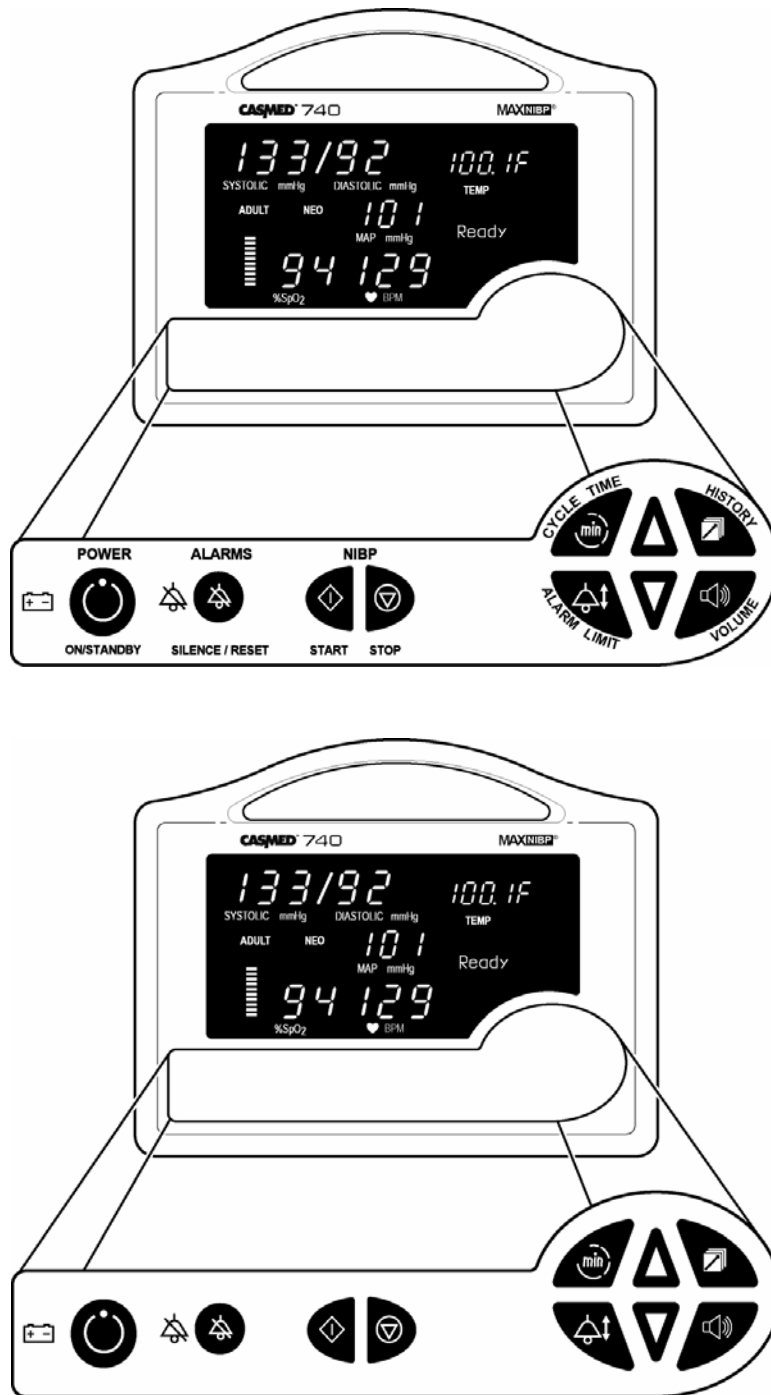

Figure 14: Front Panel Controls

**ON/STANDBY:**

Press once, turns "ON" the CASMED 740 Monitor's display (if it was OFF).

To turn the monitor's display "OFF", either press once or press and hold for two (2) seconds. Based on the selection for Power-Off Delay Time in the Configuration menu. Refer to Page 101 for more information.

**SILENCE/RESET:**

When pressed during an active patient alarm, silences the audio portion of that alarm for fifteen (15) seconds.

When pressed during an active equipment alarm, the alarm condition shall be acknowledged along with the audio and visual shall be removed.

Used to enable and disable the two (2) Minute Audio Alarm Silence or Permanent Audio Alarm Silence feature. Refer to Page 101, AUDIO ALARM SILENCE (SILENCE/RESET Pushbutton) for more information.

Allows the user to clear NIBP, SpO₂ and Temperature messages from the front panel display.

**START/STAT:****START:**

Initiates a blood pressure measurement in the Manual Mode or begins the selected Automatic Cycle.

STAT:

Starts a series of NIBP measurements (press and hold for two (2) seconds). Continues for five minutes.

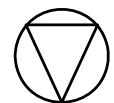
**CANCEL:**

Cancels any active blood pressure function and immediately deflates the cuff.

Also used to cancel out of a menu and return to "Ready".



CYCLE TIME:

Allows the user to select a time interval for Automatic blood pressure measurement.

Automatic measurement cycles of 1, 2, 3, 4, 5, 10, 15, 30, 60, or 90 minutes may be chosen.

Also used to read the monitor's current time (press and hold for two (2) seconds).



HISTORY:

Allows the user to review stored patient readings. Refer to Page 88, HISTORY MODES for more information.

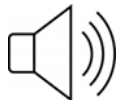

VOLUME:

Used to set the volume level of the Alarms and the SpO₂ Beep (if SpO₂ installed). Use the Up and Down Arrows to change.

Also used to adjust the brightness of the front panel displays (press and hold for two (2) seconds).

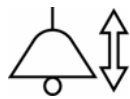

ALARM LIMITS:

Allows the user to enter and set the monitor's Alarm Limits.



ARROW UP:

Allows forward Adjustment (Auto Cycle, History, Inflation Pressure, Limits and Monitor Configuration).

Press to cycle through menu selections or press and hold for quicker advance.



ARROW DOWN:

Allows backwards Adjustment (Auto Cycle, History, Inflation Pressure, Limits and Monitor Configuration).

Press to cycle through menu selections or press and hold for quicker advance.

NEXT

The HISTORY and VOLUME pushbutton keys have been programmed to allow the user to advance forward to the *next* selection in the Monitor Configuration menu.

PREVIOUS

The CYCLE TIME and ALARM LIMITS pushbutton keys have been programmed to allow the user to advance backwards to the *previous* selection in the Monitor Configuration menu.

INFRARED (Ir) DATA PORT

An Infrared (Ir) output port, located on the bottom panel of the monitor's front cover, is available to print the NIBP, %SpO₂ and Temperature History data to the optional external printer or other data collection device(s).

CASMED 740 Monitors

REAR PANEL

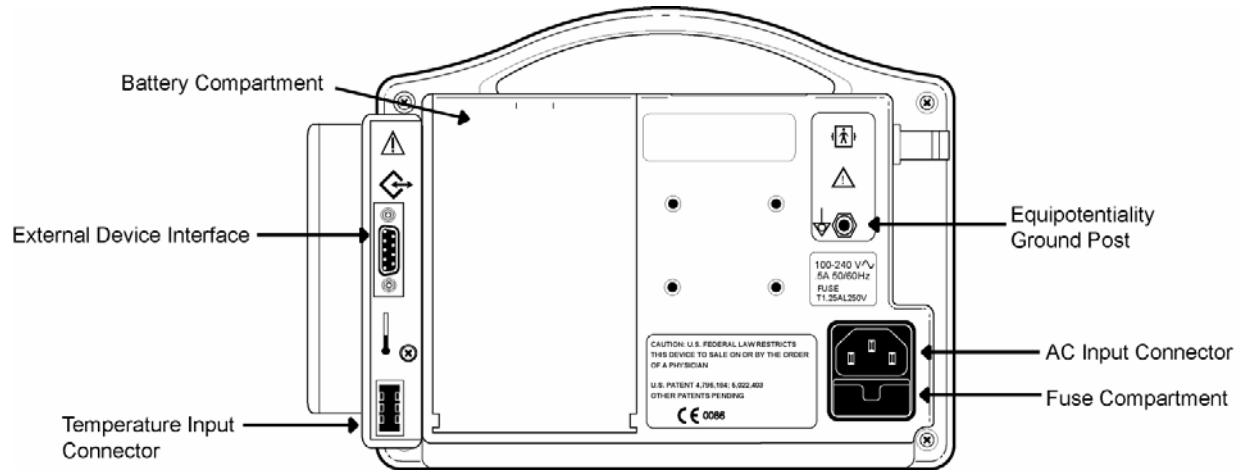

SureTemp

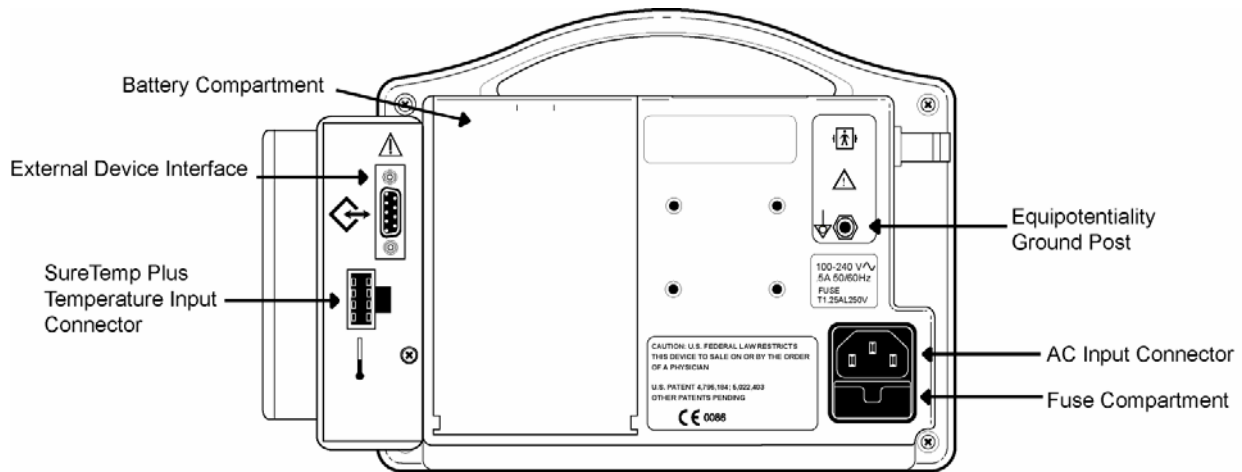

SureTemp Plus

Figure 15: 740 Rear Panel View

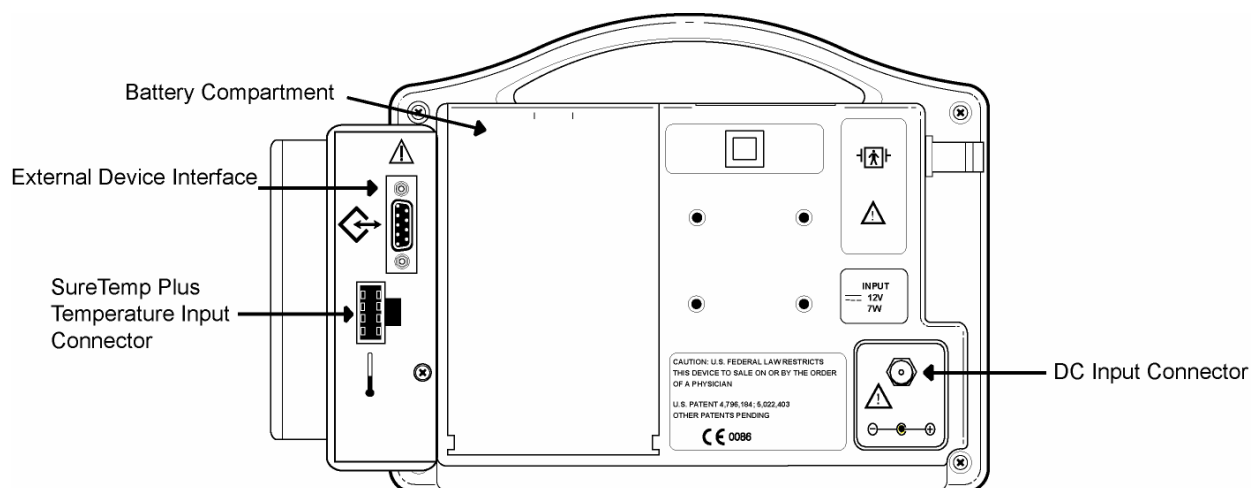

Figure 16: 740M Rear Panel View

AC / DC CONNECTION

Receptacle for the AC power cord when the CASMED 740 Monitor is purchased with an AC Line Power option and built-in battery.

When the CASMED 740 Monitor is purchased as an EMS monitor equipped with a Swivel Mount, the ambulance DC power cord is attached here.

FUSE COMPARTMENT

When the CASMED 740 Monitor is purchased for AC Line power, the power input receptacle incorporates dual fuses located in the hot and neutral lines.

BATTERY COMPARTMENT

The CASMED 740 Monitor is equipped with a 7.2 Volt, 3700 mAh battery pack that, when fully charged, is capable of taking 100 NIBP readings when the monitor is set in the 5-minute Automatic Mode.

NOTE:

The serial number label is located on the bottom of the monitor.

TEMPERATURE PROBE ELECTRICAL CONNECTION

(if equipped)

Connect the Temperature cable in this receptacle for Temperature monitoring. Leave the probe connection in place. The Temperature function is OFF until the probe is removed from the holder. Refer to Section 7, TEMPERATURE MONITORING for more information.

CASMED 740 Monitors

EQUIPOTENTIALITY GROUND POST

This terminal can be used to provide an auxiliary ground for the monitor.

EXTERNAL DEVICE INTERFACE

The CASMED 740 Monitor is available with a combined optional DB9 RS232 output and Nurse Call interface. The RS232 output may be used to interface to the Citizen CMP-10 Mobile Printer or another serial printing device.

Refer to Section 12, EXTERNAL DEVICE INTERFACING for more information.

LEFT SIDE VIEW

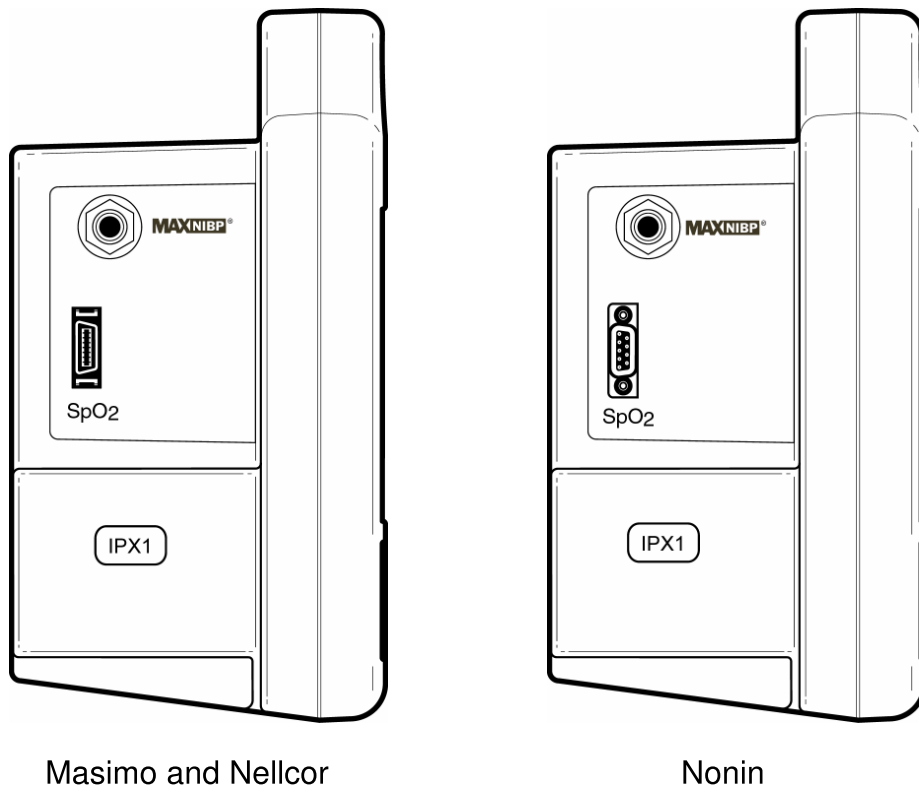

Figure 17: Left Side Panel Views



CUFF HOSE CONNECTION

The inflation hose is connected to the monitor where the MAXNIBP logo is located as shown in Figure 17. The hose must be connected to the cuff prior to use.

NOTE:

An optional six (6) foot inflation hose is available when monitoring in the NEO mode. Refer to Section 13, ACCESSORIES for part number information.

SpO₂ SENSOR CONNECTION

(if equipped)

Connect the sensor cable in this receptacle for SpO₂ monitoring.

RIGHT SIDE VIEW

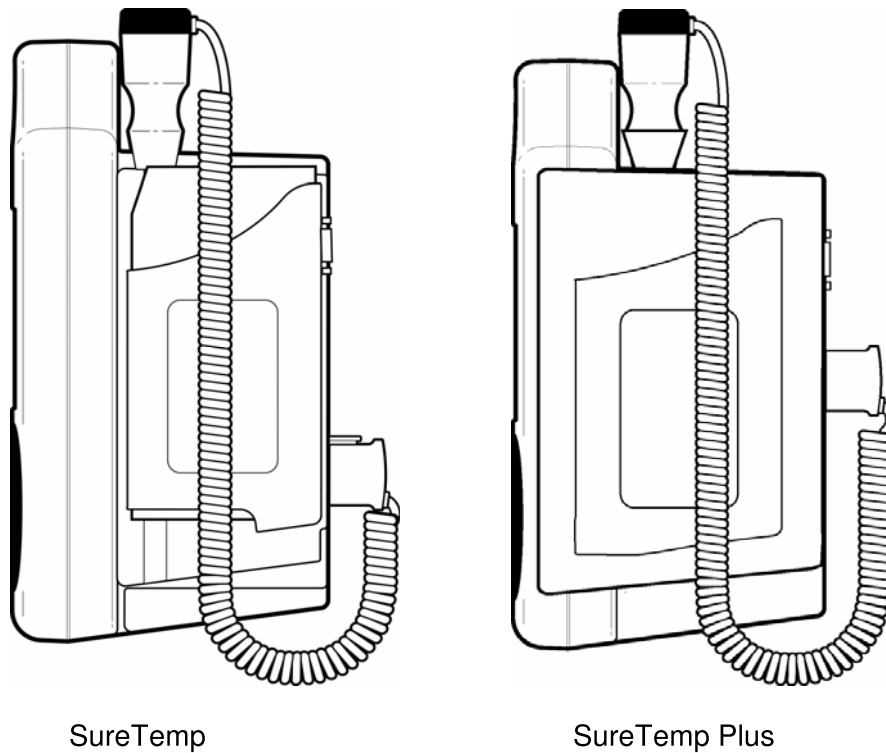

Figure 18: **Right Side Panel View**

TEMPERATURE HOLDER

(if equipped)

Store the Temperature Probe and Temperature Probe Covers in their holder locations when it is not in use.

NOTE:

Insure that the Temperature probe is secured in its holder. An audible “click” should be heard when the SureTemp probe is completely placed into its holder. The SureTemp Plus probes will slide in and out of the Probe Well without any restrictions.

MONITOR OPERATING INSTRUCTIONS

ADULT/ NEONATE OPERATING MODE

NIBP and Temperature functions are affected by changing between ADULT and NEONATE operating modes.

IMPORTANT:

Prior to patient monitoring, ensure the monitor is configured to the appropriate patient mode – Neonate or Adult. Refer to Page 100, SELECTING THE PATIENT MODE for more information.

Once power has been applied, a visual indicator, located on the front panel of the monitor, indicates the current operating mode.

The monitor's operating mode may also be set when the monitor power is being turned "ON".

The factory default is the Adult mode. To set the CASMED 740 Monitor to the Neonate mode, press and hold the ARROW DOWN pushbutton while turning monitor power "ON". The Neonate visual indicator will be displayed on the Main display.

To set the CASMED 740 Monitor to the Adult mode, press and hold the ARROW UP pushbutton while turning monitor power "ON". The Adult visual indicator will be displayed on the Main display.

The monitor will operate in the mode selected until it is changed.

TURNING THE CASMED 740 MONITOR "ON"

Press the ON/STANDBY pushbutton on the front panel to turn the monitor "ON".

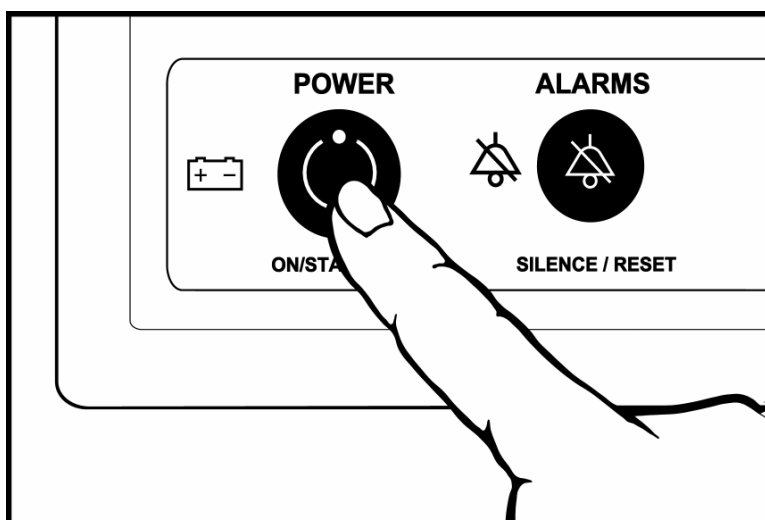

Figure 19: Turning the Monitor On

CASMED 740 Monitors

Each time the monitor is turned “ON”, a one (1) second Configuration Setup Test and a four (4) second electronic Power On Self-Test (POST) is conducted to ensure that its internal circuits are functioning properly.

NOTE:

The user should use the Power On Self Test as a verification tool that all front panel visual indicators and the audio are functioning properly.

The one (1) second Configuration Setup Test is a visual indication of the CASMED 740 Monitor’s current configuration. It consists of the monitor’s Model number and a description of its power source (740 or 740M), an Installed Parameter Code (1, 2, 3) and a one (1) or two (2) character module configuration code.

As an example, upon power-up the CASMED 740 Monitor displays: 740-2MS.

- The first set of characters indicates the Model number and the source of its power supply (740 = Internal/AC Line Power or 740M = DC connection).
- The second character (2) describes how many parameters are installed in the monitor. The monitor in our example is configured for NIBP and SpO₂. Installed Parameter Codes include;
 - (1) = NIBP; (2) = NIBP and SpO₂ or Temperature; (3) = NIBP, SpO₂ and Temperature
- The third set of characters (MS) describes the type of module installed. The monitor in our example is configured for Masimo oximeter. Configuration Codes are;
 - MS = Masimo; NL = Nellcor; NN = Nonin; T = Temperature

The four (4) second Power On Self-Test consists of:

- All equipped parameter segments are lit for one (1) second.
- All High Alarm Values are displayed for one (1) second in their corresponding numeric display window and an audible tone is emitted from the monitor’s internal speaker. The Message Window indicates “HI LIMS”.
- All Low Alarm Values are displayed for one (1) second in their corresponding numeric display window and an audible tone is emitted from the monitor’s internal speaker. The Message Window indicates “LO LIMS”.
- The monitor’s current time is displayed for 1 second.

NOTE:

If the printer was powered “ON” during the monitor’s power-up sequence, the CAS Medical Systems logo is printed.



Once the Power On Self Test is completed, the monitor indicates that it is “Ready” for use.

FRONT PANEL INTENSITY CONTROL

The CASMED 740 Monitor utilizes Super Bright LED displays in its front panel for better viewing in a variety of environments. If the displays are too bright or should the need come to operate the monitor in a dimly lit environment, the monitor incorporates a user selectable Intensity Control.

Press and hold the front panel VOLUME pushbutton for two (2) seconds. The monitor's front panel LED displays will toggle from their bright to their dim intensity level.

Continue to press the VOLUME pushbutton and every two (2) seconds the monitor's front panel LED displays will toggle; dim to bright, bright to dim etc. Release the VOLUME pushbutton and select the intensity level required. The CASMED 740 Monitor remembers this setting and will power-up the next time to the intensity level selected.

DISPLAYING THE TIME

The CASMED 740 Monitor can be used to display the current Time of day (as set by the user) at any time. Press and hold the CYCLE TIME pushbutton for two (2) seconds.

The monitor displays the Time, in 24 Hr. format in the Message Window for as long as the pushbutton is pressed.

MANUAL MODE FOR BLOOD PRESSURE DETERMINATION

Select and apply the appropriate sized cuff for the patient being monitored to the extremity. Refer to Section 5, BLOOD PRESSURE MONITORING for more information.

Connect the cuff to the end of the monitor tubing. Connect the monitor tubing to the NIBP connector, located on the left side of the monitor.

To select one of the Initial Inflation Pressures shown in TABLE 4, press either the ARROW UP or the ARROW DOWN pushbutton or accept the default Initial Inflation Pressure of 150 mmHg (Adult) or 85 mmHg (Neonate).

CAUTION:

When measuring blood pressure on a Pediatric patient, using the ADULT mode, it is recommended that the Initial Inflation Pressure be set to a lower value of 120 mmHg.

ADULT MODE	NEONATE MODE
200 mmHg	120 mmHg
180 mmHg	100 mmHg
160 mmHg	85 mmHg
150 mmHg	80 mmHg
140 mmHg	60 mmHg
120 mmHg	
100 mmHg	
80 mmHg	

Table 2: **Selectable Initial Inflation Pressures**

CASMED 740 Monitors

IMPORTANT:

Excessive patient motion can contribute to inaccurate measurements. It is important that the patient be kept still during a measurement. Make every attempt to alleviate fear, anxiety and pain.

Press the START pushbutton to begin a measurement. For the first measurement the monitor will inflate to the default setting or the Initial Inflation Pressure selected.

NOTE:

When the monitor is configured in the Alarms Off mode, the message “Arm Off” is displayed in the Message Window, the cuff inflation pressure will always be set to 150 mmHg (Adult) and 85 mmHg (Neonate). Also, as an example, if the Initial Inflation Pressure was set to 100 mmHg, the first NIBP inflation pressure would be 100 mmHg followed by pressures at 150 mmHg.

The monitor’s front panel NIBP displays will indicate all dashes “- -” while the measurement is in progress and the Message Window displays the Inflation Pressure in the format “Meas XXX”, where “XXX” is the pressure value. For subsequent measurements, the monitor will inflate approximately 30 mmHg higher than the previously determined Systolic pressure.

The measurement typically takes less than 30 seconds to complete. In no case will the cuff remain pressurized for more than 120 seconds for Adult/Pediatric patients and no more than 90 seconds for Neonates.

When the measurement is completed, the cuff will automatically deflate and the monitor will display the Systolic, Diastolic, MAP (if enabled), and Pulse Rate values on the front panel displays. The Message Window displays a time stamp of the NIBP measurement in the format “BP HH:MM”. Where “HH” is the hour and “MM” is the minute of the measurement taken.

NOTE:

If SpO₂ is active, the Pulse Rate value will be determined from the SpO₂ measurement.

Press the CANCEL pushbutton, at any time, to stop a measurement and deflate the cuff during the measurement process. The monitor’s front panel NIBP displays will indicate all dashes “- -” and the Message Window returns to “Ready”.

The CANCEL pushbutton can be pressed after a measurement is taken to clear the current reading from the displays. The monitor’s front panel NIBP displays will indicate all dashes “- -” and the Message Window returns to “Ready”.

NOTE:

If any displayed NIBP measurement were to be left on the display for up to twenty-four (24) hours, the monitor will automatically blank the displays to all dashes “- -” and the Message Window returns to “Ready”.

AUTOMATIC CYCLE FOR BLOOD PRESSURE DETERMINATION

The CASMED 740 Monitor can automatically take blood pressure measurements at pre-selected time intervals.

To choose a time interval, press the CYCLE TIME pushbutton. The Message Window displays the format "Auto XX". Where "XX" is the time interval in minutes.

Choose the time interval using one of the following methods:

- 1) Press the CYCLE TIME pushbutton to advance through the available time intervals.
- 2) Press the ARROW UP or ARROW DOWN pushbutton keys to advance forward or backwards through the available time intervals.

Once a time interval has been selected, press the START pushbutton to begin the first measurement.

Between each measurement, the Message Window will display the time remaining until the next measurement, as well as the cycle time chosen in the format "MM:SS CC" where "MM" is the minutes and "SS" is the seconds until the next measurement and "CC" is the cycle time selected.

The measurement results are displayed on the front panel until the start of the next measurement cycle.

NOTE:

If a measurement is desired between measurement cycles, press the START pushbutton. After this measurement, the monitor will re-enter the Automatic Cycle mode and countdown to the next measurement based on the Cycle time selected.

In the Automatic Mode, while during a measurement or in the idle time between measurements, pressing the CANCEL pushbutton will cause the monitor to exit the Automatic mode and return to the Manual mode. The monitor's front panel NIBP numeric displays will indicate the reading of the previous measurement taken and the Message Window will display the time stamp of that reading.

NOTE:

The Automatic Cycle mode is not saved during a power cycle.

STAT MODE

WARNING:

Readings obtained during STAT mode may not meet the stated accuracy of this monitor.

WARNING:

In some cases, rapid, prolonged cycling of an oscillometric, noninvasive blood pressure monitor cuff has been associated with any or all of the following: ischemia, purpura, or neuropathy. Apply the oscillometric cuff appropriately, according to instructions, and check the cuff site and cuffed extremity regularly when blood pressure is measured at frequent intervals or over extended periods of time.

CASMED 740 Monitors

The CASMED 740 Monitor can automatically take a series of blood pressure measurements for a five (5) minute interval with a brief (approx. ten (10) second) pause between determinations to allow venous blood return.

Press and Hold the START/STAT pushbutton for two (2) seconds to activate this feature. The Message Window will display "STAT XXX", where "XXX" is the real time cuff pressure. Between readings the Message Window will display "0:XX S" where "XX" is the 10-second count down until the next measurement.

After five (5) minutes of determinations the monitor will stop taking measurements and exit the STAT mode. The monitor will return to the Manual mode and the Message Window will return to the "Ready" message.

In the STAT Mode, while during a measurement or in the idle time between measurements, pressing the CANCEL pushbutton will cause the monitor to exit the STAT mode and return to the Manual mode. The monitor's front panel NIBP numeric displays will indicate the reading of the previous measurement taken and the Message Window will display the time stamp of that reading.

NOTE:

Pressing the CYCLE pushbutton during the Manual, Automatic or STAT Modes will terminate the current NIBP measurement (if active) and place the monitor in the Automatic Cycle mode. The user will then be allowed to alter the Cycle time, if necessary, and begin a new NIBP measurement.

WARNING:

When monitoring over an extended period of time, or at frequent intervals, periodically observe the patient's limb to make sure that the circulation is not impaired for a prolonged period of time.

HISTORY MODES

The History Modes allow the user to recall previously taken measurements. The measurement results and the time the measurement was taken are also displayed.

Patient History is organized in two visually displayed lists.

Event History: Pressing the HISTORY pushbutton the first time reveals the first viewable list that contains up to 480 entries of Event driven data (NIBP and Predictive Temperature (if installed)) along with the corresponding %SpO₂ results (if installed).

Trend History: Pressing the HISTORY pushbutton again reveals the second viewable list that contains up to 480 entries of Trend History at one (1) minute intervals. The Trend History contains all the events from the Event History log combined with readings that are saved every minute consisting of: a one (1) minute average of the %SpO₂ values (if installed) and Monitor Mode Temperature values (if installed).

NOTE:

Both Event and Trend History data are only available for twenty-four (24) hours. Data older than twenty-four (24) hours is automatically removed from the History lists.

Once the HISTORY pushbutton has been pressed, use the HISTORY pushbutton to toggle between the two History menus.

When completed, press the CANCEL pushbutton to return to "Ready" or after thirty (30) seconds of button inactivity the monitor will automatically return to "Ready".

NOTE:

History data values for NIBP and Predictive Temperature are saved as they occur. History data values for %SpO₂ (one (1) minute averages) and Monitor Temperature are saved once a minute.

NOTE:

Turning the power "OFF" does not clear the History memory. Measurements will remain in memory for up to twenty-four (24) hours. Any measurement older than twenty-four hours is deleted. It is suggested to manually clear History between patients (See CLEARING HISTORY on Page 91).

EVENT HISTORY (EVENT-Ev)

To review History based on Event readings, press the HISTORY pushbutton. The most current measurement (NIBP or Predictive Temperature) and the time of measurement (HH:MM-Ev) are displayed on the front panel along with their corresponding %SpO₂ values. If there are no readings in the History, the message "No Evnts" is displayed in the Message Window.

Press the ARROW DOWN pushbutton to review preceding measurements. The word "Oldest" will be displayed briefly on the Message Window when there are no more readings left in the memory. The oldest measurement will then be redisplayed.

Press the ARROW UP pushbutton to advance the measurements towards the most current measurement taken. The word "Newest" will be displayed briefly on the Message Window when there are no more current readings. The most recent measurement will then be redisplayed.

To exit the History Mode and return to "Ready" press the CANCEL pushbutton. If a measurement is desired immediately while in the History Mode, simply press START. This will exit the History Mode and begin a measurement.

CASMED 740 Monitors

TREND HISTORY (TREND-Tr)

NOTE:

If the CASMED 740 Monitor is not equipped for SpO₂ or Temperature monitoring, no Trend History menu will be available.

To review Trend History, press the HISTORY pushbutton twice. The most current measurement (NIBP, Predictive or Monitor Temperature or a one (1) minute averaged %SpO₂) values and the time of measurement (HH:MM-Tr) are displayed on the front panel. If there are no readings in the History, the message "No Trend" is displayed in the Message Window.

Press the ARROW DOWN pushbutton to review preceding measurements. The word "Oldest" will be displayed briefly on the Message Window when there are no more readings left in the memory. The oldest measurement will then be redisplayed.

Press the ARROW UP pushbutton to advance the measurements towards the most current measurement taken. The word "Newest" will be displayed briefly on the Message Window when there are no more current readings. The most recent measurement will then be redisplayed.

To exit the History Mode and return to "Ready" press the CANCEL pushbutton. If a NIBP measurement is desired immediately while in the History Mode, simply press START. This will exit the History Mode and begin a measurement.

NOTE:

Turning the power "OFF" does not clear the History memory. Measurements will remain in memory for up to twenty-four (24) hours. Any measurement older than twenty-four hours is deleted. It is suggested to manually clear History between patients (See CLEARING HISTORY on Page 91).

PRINT HISTORY

The stored Event History and Trend History data are printed individually. Press and Hold the HISTORY pushbutton for two (2) seconds while in either the Event or Trend History screens.

The message "Print? N" appears in the Message Window.

Use either the ARROW UP or ARROW DOWN pushbutton until the message "Print? Y" appears in the Message Window.

Press the HISTORY pushbutton again to start printing the History data. The message "Printing" appears in the Message Window as a status indicator.

NOTE:

Prior to accessing the Print History mode, the printer should have paper installed and the power turned "ON". Refer to Section 9, EXTERNAL PRINTER for more information about the printer and sample printouts of both History screens.

CLEARING HISTORY

The History data can be manually cleared by pressing and holding for two (2) seconds the HISTORY pushbutton while in either of the History modes. The message "Print? N" appears in the Message Window.

Press the HISTORY pushbutton again and the message "Erase? N" appears in the Message Window.

Use either the ARROW UP or ARROW DOWN pushbutton until the message "Erase? Y" appears in the Message Window.

Press the HISTORY pushbutton a final time and the message "Erasing" appears in the Message Window. The monitor erases the memory, exits the History mode and returns to the "Ready" state.

REAL TIME CLOCK (RTC)

The CASMED 740 Monitor uses an internal Real Time Clock to time stamp all entries that are stored in History. Changes made to either the time or date settings, should be performed in-between patients being monitored. Refer to Page 85, for displaying the monitors time and Page 104, for setting the time.

PATIENT ALARM MODE

WARNING:

Configuring the CASMED 740 Monitor's alarm settings to "OFF" will disable all audible and visual alarms. This mode should only be selected for spot check applications where the patient is receiving bedside surveillance by a trained clinician. Refer to Page 101, AUDIO ALARM SILENCE (SILENCE/RESET Pushbutton) for more information.

The CASMED 740 Monitor is equipped with patient alarms to warn the user if any measurement parameter is outside the range of a user set value. This feature will allow the user to set values for:

- Systolic High and Low
- Diastolic High and Low
- MAP High and Low
- Pulse High and Low
- %SpO₂ High and Low

CASMED 740 Monitors

CHANGING ALARM LIMITS

The CASMED 740 Monitor incorporates a two (2) step process for reviewing and changing Alarm Limit values.

Press the ALARM LIMITS pushbutton once and the monitor's front panel displays indicate the current values of all High Alarm Limit values, for two (2) seconds then toggles to indicate all Low Alarm Limit values for two (2) seconds. This reviewing of all High and Low Alarm Limit values continues for thirty (30) seconds if no other pushbutton is pressed.

To change the value of an Alarm Limit, press the ALARM LIMITS pushbutton again. The Alarm Limit value is displayed in its corresponding display window and the Message Window will display the limit's name.

Use the ARROW UP or ARROW DOWN pushbuttons to change the limit value. Use the ALARM LIMITS pushbutton key to advance onto the next parameter value.

Press the CANCEL pushbutton to return to "Ready" or after thirty (30) seconds of button inactivity the monitor will automatically return to "Ready". The alarm value(s) set will now be used until power is turned "OFF".

SAVING ALARM LIMITS

To save the Alarm Limit values to non-volatile memory, press and hold the ALARM LIMITS pushbutton for two (2) seconds while in the Alarm Limits set value mode. The Message Window will display "Save? N".

Press either the ARROW UP or ARROW DOWN pushbuttons will display "Save? Y" in the Message Window. Press the ALARM LIMIT pushbutton a final time.

The Message Window will display "Saving" and the current value(s) will be saved in memory. When finished, press the CANCEL pushbutton to return to the "Ready" state. These values will be retained in memory even after the monitor is turned "OFF".

RESTORE FACTORY DEFAULTS

To restore the factory default settings, press the ALARM LIMITS pushbutton to enter the Alarm Limits mode.

Press and hold the ALARM LIMITS pushbutton for 2 seconds until the message "Saving? N" appears in the Message Window.

Press the ALARM LIMITS pushbutton to bring up the Recall menu. The message "Recall? N" appears in the Message Window. Pressing either the ARROW UP or ARROW DOWN pushbutton will display the message "Recall? Y" in the Message Window.

Press the ALARM LIMITS pushbutton. The Message Window will display "Restore" and return to the Alarm Limit menu. When finished, press the CANCEL pushbutton to return to the "Ready" state.

ALARM LIMIT VALUES

There are two sets of alarm limit parameters, one for Adult/Pediatric and one for Neonatal. The Alarm Limits pushbutton will operate on the parameters for the mode the monitor is currently in (ADULT / NEO). Table 5, lists the Alarm Limit Default Values used by the CASMED 740 Monitor.

ADULT	Systolic	Diastolic	MAP	Pulse	%SpO₂
High	240	130	180	220	OFF
Low	OFF	OFF	OFF	OFF	88
NEONATAL	Systolic	Diastolic	MAP	Pulse	%SpO₂
High	120	80	100	220	96
Low	OFF	OFF	OFF	OFF	88

Table 3: **Default Alarm Values**

NOTE:

Switching modes from Adult to Neonate or Neonate to Adult, shall recall the last stored values for patient alarm limit.

NOTE:

Patient alarms for Systolic, Diastolic and MAP values are produced at the time the measurement is taken. Alarms for %SpO₂ have a ten (10) second delay. Alarm for Pulse Rate will be immediate if taken from the NIBP or have a ten (10) second delay if taken from the SpO₂ signal.

CASMED 740 Monitors

AUDIBLE AND VISUAL INDICATORS

The CASMED 740 Monitor is capable of producing both an audible and a visual indicator for a variety of monitor conditions. The following table provides a cross reference for audible and visual indications.

Alarm Condition	Priority Level	Audible Indication	Visual Indication
Dead Battery	High	3 Beeps followed by 2 Beeps every 10 seconds	The message is displayed continuously in the Message Window. The Battery Power Visual Indicator is Red.
Patient Alarm Limit Violations	High	3 Beeps followed by 2 Beeps every 10 seconds	The associated 7-segment LED flashes for one second on / one second off for the parameter limit in violation.
SpO ₂ % Alarm Limit Violations			The message is displayed for one second every two to six seconds in the Message Window *.
Power Fail	High	3 Beeps followed by 2 Beeps every 10 seconds	The message is displayed for one second every two to four seconds in the Message Window *.
Low Battery Alarm	Medium	3 Beeps every 25 seconds	The message is displayed for one second every two to six seconds in the Message Window *. The Battery Power Visual Indicator is Red.
NIBP Application Error	Medium	3 Beeps every 25 seconds	The message is displayed for one second every two to six seconds in the Message Window *.
SpO ₂ Probe Alarms	Medium	3 Beeps every 25 seconds	The message is displayed for one second every two to six seconds in the Message Window *.
NIBP Complete	Low	1 Beep when blood pressure is completed	Numerics are updated with each blood pressure taken.
SpO ₂ Pulse Beat	Low	1 Beep coincides with each received SpO ₂ pulse rate	Numerics are updated with each received SpO ₂ pulse rate value.
Temperature Complete	Low	1 Beep when final temperature is completed	Numerics are updated when a final temperature is completed.
Key Click	Low	1 Beep associated with each button action	None

Table 4: Audible and Visual Indicators

* - The message interval time will vary based on what monitor conditions are present.

NOTE:

Refer to Table 8, on Pages 113 for a listing of messages that may be displayed in the Message Window.

CLEARING ALARMS

The CASMED 740 Monitor provides to the user an audible and visual indication for both patient and equipment alarm conditions.

NIBP PATIENT ALARMS

During an active NIBP Patient Alarm Limit Violation (Low/High Systolic or Low/High Diastolic), the monitor flashes the LED display of the parameter in alarm and provides a Patient Alarm Limit Violation audible tone.

To acknowledge the alarm, press the SILENCE/RESET pushbutton.

The monitor silences the audible tone and the parameter in alarm stops flashing.

HIGH / LOW %SpO₂ ALARMS

During either a High or Low %SpO₂ Alarm Limit Violation, the monitor flashes the %SpO₂ LED display, provides a Patient Alarm Limit Violation audible tone and displays the appropriate message (SpO₂ Hi or SpO₂ Lo) in the Message Window.

To acknowledge the alarm and temporarily mute the audio, press the SILENCE/RESET pushbutton.

The monitor silences the audible tone for a maximum of fifteen (15) seconds, the parameter in alarm continues to flash on the front panel and the appropriate message will be displayed in the Message Window. If the current patient alarm condition becomes inactive during the 15 seconds and then recurs OR a different patient alarm condition occurs during the 15 seconds, the audio alarm is reactivated. If the alarm condition continues uninterrupted for the 15 seconds, the audio alarm is reactivated.

SpO₂ PULSE RATE ALARM

During a SpO₂ Pulse Rate Alarm Limit Violation, the monitor flashes the ♥BPM LED display and provides a Patient Alarm Limit Violation audible tone.

To acknowledge the alarm and temporarily mute the audio, press the SILENCE/RESET pushbutton.

The monitor silences the audible tone for a maximum of fifteen (15) seconds and the parameter in alarm continues to flash on the front panel. If the current patient alarm condition becomes inactive during the 15 seconds and then recurs OR a different patient alarm condition occurs during the 15 seconds, the audio alarm is reactivated. If the alarm condition continues uninterrupted for the 15 seconds, the audio alarm is reactivated.

CASMED 740 Monitors

EQUIPMENT ALARMS

During an Equipment Alarm, the monitor displays the alarm parameter in either the Message Window or flashes the LED display of the alarmed parameter and provides an audible Alarm Tone. To clear the alarm, press the SILENCE/RESET pushbutton. The monitor silences the audible tone and clears the parameter.

NOTE:

The Low Battery and Dead Battery alarms cannot be silenced.

ADJUSTING THE AUDIO ALARM VOLUME

The Alarm Volume can be adjusted to one (1) of five (5) volume levels. Press the VOLUME pushbutton. The Message Window displays the current value of the Audio Alarm Volume “ALARM ”.

Use the ARROW UP and ARROW DOWN pushbuttons to adjust the volume level desired. Altering the Alarm Volume will produce a single tone at the selected volume level.

Press the CANCEL pushbutton when completed.

NOTE:

The Volume Level cannot be set to “OFF”.

NOTE:

No “Key Click” will be heard when the Audio Volume is set to a MINIMUM setting.

ADJUSTING THE SpO₂ “BEEP” VOLUME

(available if SpO₂ is installed)

The Volume for the SpO₂ “Beep” can be adjusted to one (1) of five (5) levels and “OFF”. This setup menu follows directly after the Audio Alarm Volume. Press the VOLUME pushbutton until the Message Window displays the SpO₂ Volume message “SpO₂ ”.

Use the ARROW UP and ARROW DOWN pushbuttons to adjust the volume level desired. Altering the SpO₂ Volume will produce a single tone at a selected “non-off” volume level.

Press the CANCEL pushbutton when completed.

2-MINUTE AUDIO SILENCE

NOTE:

Enabling the 2-Minute Audio Alarm Off mode can only be accomplished after all active alarm conditions have been addressed. To clear an alarm, refer to Page 95, CLEARING ALARMS for more information.

If the 2-Minute Audio Off mode is selected in the Monitor Configuration menu, pressing the SILENCE/RESET pushbutton will temporarily deactivate the audio alarms for two (2) minutes. The visual indicator next to the SILENCE/RESET pushbutton will illuminate continuously and the message “2Min Aud” will be displayed along with the “Ready” message in the Message Window as a reminder.

NOTE:

If the Message Window is currently displaying a time stamp from a previously taken NIBP measurement, the “2Min Aud” message will alternately be displayed with the time stamp message.

When the 2-Minute Audio Off is enabled, the monitor will not alarm for patient related High and Low alarms, NIBP Application Error and SpO₂ Probe Alarm. The monitor will alarm for Low Battery and Dead Battery.

To re-activate the audio alarm, press the SILENCE/RESET pushbutton again. The visual indicators will go out. If the button is not pressed, audible alarms will be re-armed automatically after two (2) minutes. Refer to Page 101, AUDIO ALARM SILENCE (SILENCE/RESET Pushbutton) for more information.

PERMANENT AUDIO ALARM SILENCE

NOTE:

Enabling the Permanent Audio Alarm Off mode can only be accomplished after all active alarm conditions have been addressed. To clear an alarm, refer to Page 95, CLEARING ALARMS for more information.

If the Permanent Audio Off mode is selected in the Monitor Configuration menu, pressing the SILENCE/RESET pushbutton will deactivate the audio alarms. The visual indicator next to the SILENCE/RESET pushbutton will flash at a rate of one (1) second “ON” and one (1) second “OFF” and the message “Perm Aud” will be displayed along with the “Ready” message in the Message Window as a reminder.

NOTE:

If the Message Window is currently displaying a time stamp from a previously taken NIBP measurement, the “Perm Aud” message will alternately be displayed with the time stamp message.

When enabled, the monitor will not alarm for patient related High and Low alarms, NIBP Application Error and SpO₂ Probe Alarm. The monitor will alarm for Low Battery and Dead Battery.

To re-activate the audio alarm, press the SILENCE/RESET pushbutton again. The visual indicators will go out. Refer to Page 101 AUDIO ALARM SILENCE (SILENCE/RESET Pushbutton) for more information.

CASMED 740 Monitors

ALARM LIMITS OFF

If the Alarm Limits Off mode is selected in the Monitor Configuration menu, all alarms associated with patient alarms are “OFF” except for Low Battery and Dead Battery. The visual indicator next to the SILENCE/RESET pushbutton will flash at a rate of two (2) second “ON” and two (2) seconds “OFF” and the message “Alrm Off” will be displayed along with the “Ready” message in the Message Window as a reminder.

When the Alarm Limits Off is selected, the ALARM LIMITS pushbutton is inactive. The Alarm Limits Off mode cannot be disabled with the SILENCE/RESET pushbutton.

NOTE:

If the Message Window is currently displaying a time stamp from a previously taken NIBP measurement, the “Alrm Off” message will alternately be displayed with the time stamp message.



To re-activate the audio alarms, refer to Page 101, AUDIO ALARM SILENCE (SILENCE/RESET Pushbutton) for more information.

MONITOR CONFIGURATION

The Monitor Configuration section allows the user to configure the CASMED 740 Monitor to your individual needs. Once entered, the user can:

- Review the monitor’s internal Software Revisions
- Select the Operating Language
- Select the Patient Mode
- Select the Power-Off Delay Time
- Select the Temperature Scale
- Make selections for Audio Alarms
- Choose to display the MAP value
- Set the SpO₂ Alarm Delay
- Set the Date
- Set the Time
- Set Daylight Saving Time Option
- Perform System Checks (Refer to Page 136, CALIBRATION CHECK)
 - Manometer Mode
 - Leak Check

ENTERING THE CONFIGURATION MENU

To enter the monitor’s Configuration Menu, press and hold the VOLUME  and ALARM LIMITS  pushbutton keys while the monitor is being turned “ON” .

Once in the menu, use one of the NEXT (HISTORY / VOLUME) or PREVIOUS (CYCLE TIME / ALARM LIMITS) programmed pushbutton keys to advance onto the next or go back to the previous parameter in the Configuration Menu.

NOTE:

While in the Configuration Menu, if no pushbutton is pressed within 60 seconds, the monitor will automatically save all changes made and exit the Monitor Configuration menu. The Message Window will briefly display "Saving" and return to the "Ready" mode.

SAVING YOUR CHANGES

When you have completed configuring the monitor, press the CANCEL pushbutton to exit and lock in your selection(s). The Message Window will briefly display "Saving" and return to the "Ready" mode.

SOFTWARE REVISIONS

The CASMED 740 Monitor displays the current software revision of its operating system and that of the internal modules being used inside. The software versions are displayed in the following order:

Software Module	Message Window
CASMED 740 Control Board	Ver X.X
Boot Loader	Boot X.XX
Power Supply PIC Processor	PIC X.X
CAS NIBP Module	ND X.X
Nellcor SpO ₂ Module ⁽¹⁾	NEL X.X
Masimo SpO ₂ Module ⁽¹⁾	MAS X.X
Nonin SpO ₂ Module ⁽¹⁾	NON XX
Welch Allyn Temperature Module ⁽²⁾	WA X.X

Table 5: **Software Revisions**

Use the ARROW UP or ARROW DOWN pushbuttons to view the messages.

Press one of the NEXT programmed pushbutton keys to advance onto the next menu or use the CANCEL pushbutton to Save your changes and exit to the "Ready" mode.

(1) The SpO₂ module is optional, in the case when it is not installed the Version text advances to the next Module.

(2) The Temperature module is optional, in the case when it is not installed the Version text advances to the next Module.

CASMED 740 Monitors

SELECTING THE LANGUAGE

The CASMED 740 Monitor can operate in one (1) of nine (9) languages: English, German, French, Italian, Spanish, Dutch, Swedish, Portuguese or Norwegian.

To configure the monitor's operating language, first enter the Configuration menu. Refer to Page 98, ENTERING THE CONFIGURATION MENU.

Once in the menu, use one of the NEXT programmed pushbutton keys until the Message Window displays the current language being used.

Use the ARROW UP or ARROW DOWN pushbuttons to make your selection.

Press one of the NEXT programmed pushbutton keys to advance onto the next menu or use the CANCEL pushbutton to exit to the "Ready" mode.

SELECTING THE PATIENT MODE

The CASMED 740 Monitor can be used on patients from Neonates to Adults.

To configure the monitor's operating mode, first enter the Configuration Menu. Refer to Page 98, ENTERING THE CONFIGURATION MENU.

Once in the menu, use one of the NEXT programmed pushbutton keys until the Message Window displays "Patient".

Use the ARROW UP or ARROW DOWN pushbuttons to select the patient mode. The front panel display will illuminate with the patient mode selected (ADULT = Adult / Pediatric; NEO = Neonate).

NOTE:

Switching modes from Adult to Neonate or Neonate to Adult, shall recall the last stored values for patient alarm limit.

Press one of the NEXT programmed pushbutton keys to advance onto the next menu or use the CANCEL pushbutton to exit to the "Ready" mode.

NOTE:

The Patient Mode may also be changed at monitor power-up. Refer to Page 83, ADULT/NEONATE OPERATING MODE for more information.

SELECTING THE POWER-OFF DELAY TIME

The CASMED 740 Monitor incorporates a user selectable Power-Off Delay time feature.

The amount of time the ON/STANDBY pushbutton is pressed to turn the display “OFF” can be configured to be either “Off 0S” (no delay) or “Off 2S” (press and hold for 2 seconds). The default setting used by the monitor is “Off 0S”.

To configure the Power-Off Delay Time, first enter the Configuration menu. Refer to Page 98, ENTERING THE CONFIGURATION MENU.

Once in the menu, use one of the NEXT programmed pushbutton keys until the Message Window displays the monitor’s current setting for the Power-Off Delay Time.

Use the ARROW UP or ARROW DOWN pushbuttons to make your selection.

Press one of the NEXT programmed pushbutton keys to advance onto the next menu or use the CANCEL pushbutton to exit to the “Ready” mode.

SELECTING THE TEMPERATURE SCALE

(available if Temperature is installed)

The CASMED 740 Monitor can display Temperature readings in either the Celsius or Fahrenheit scales.

To select the operating Temperature scale, first enter the Configuration menu. Refer to Page 98, ENTERING THE CONFIGURATION MENU.

Once in the menu, use one of the NEXT programmed pushbutton keys until the Message Window displays the Temperature setup menu “°F” or “°C”.

Use the ARROW UP or ARROW DOWN pushbuttons to make your selection.

Press one of the NEXT programmed pushbutton keys to advance onto the next menu or use the CANCEL pushbutton to exit to the “Ready” mode.

AUDIO ALARM SILENCE (SILENCE/RESET Pushbutton)

The CASMED 740 Monitor’s SILENCE/RESET pushbutton can be configured to have the audio associated with patient alarms set to one of three selections. The selections are:

- 2-Minute Audio Alarm Silence (Default)
- Permanent Audio Alarm Silence
- Alarm Limits Off

To configure the alarms, first enter the Configuration menu. Refer to Page 98, ENTERING THE CONFIGURATION MENU.

CASMED 740 Monitors

Once in the menu, use one of the NEXT programmed pushbutton keys until the Message Window displays the monitor's current value of the Audio Alarms menus.

Use the ARROW UP or ARROW DOWN pushbuttons to make your selection.

Press one of the NEXT programmed pushbutton keys to advance onto the next menu or use the CANCEL pushbutton to exit to the "Ready" mode.

2-MINUTE AUDIO ALARM SILENCE

When the monitor is configured for the 2-Minute Audio Alarm Silence setting, use the SILENCE/RESET pushbutton to "enable or disable" audio alarms for a two (2) minute period. The SILENCE visual indicator, located on the front panel of the monitor will be illuminated constantly and the message "2Min Aud" will be displayed on the Message Window as a reminder when enabled. At the end of two (2) minutes, the monitor will automatically exit the 2-Minute Audio Alarm Silence setting and return to normal operation.

During a two-minute silence period, if an alarm (patient or equipment) occurs, except for Low Battery and Dead Battery, the audio alarm remains silenced for the remainder of the two-minutes and only a visual indicator is provided.

PERMANENT AUDIO ALARM SILENCE

When the monitor is configured to the Permanent Audio Alarm Silence setting, use the SILENCE/RESET pushbutton to "enable or disable" audio alarms. The SILENCE visual indicator, located on the front panel of the monitor will flash at a rate of one (1) second "ON" and one (1) second "OFF" and the message "Perm Aud" is displayed on the Message Window as a reminder when enabled.

During a permanent audio alarm off period, if an alarm (patient or equipment) occurs, except for Low Battery and Dead Battery, the audio alarm remains silenced and only a visual indicator is provided.

ALARM LIMITS OFF

When the monitor is configured to the Alarm Limit Off setting, all alarms associated with patient alarms are "OFF". Also, when a NIBP measurement is started using the Manual mode, the inflation pressure will always be set to 150 mmHg (Adult mode) and 85 mmHg (Neonate mode).

This mode is useful for spot check applications or if the monitor is being moved from patient to patient and the user may not want to be disturbed by any audible alarms or have to worry about what pressure to set the monitor to.

The SILENCE visual indicator, located on the front panel of the monitor will flash at a rate of two (2) seconds "ON" and two (2) seconds "OFF" and the message "Alrm Off" will be displayed on the Message Window as a reminder when enabled.

During an alarm limit off period, if an equipment alarm occurs, except for Low Battery and Dead Battery, the audio alarm remains silenced and only a visual indicator is provided.

MAP VALUE ENABLE / DISABLE

During a blood pressure reading, the user can elect to display or not to display the MAP value.

Should it need to be changed, first enter the Configuration menu. Refer to Page 98, ENTERING THE CONFIGURATION MENU.

Once in the menu, use one of the NEXT programmed pushbutton keys until the Message Window displays the monitor's current setting for the MAP value "MAP On" or "MAP Off".

Use the ARROW UP or ARROW DOWN pushbuttons to make your selection.

NOTE:

When "MAP Off" is selected, MAP values are omitted from History Display and Printing as well. All alarms associated with MAP values are also disabled.

Press one of the NEXT programmed pushbutton keys to advance onto the next menu or use the CANCEL pushbutton to exit to the "Ready" mode.

SET THE SpO₂ ALARM DELAY

The delay time until an alarm is generated for %SpO₂ and Pulse Rate can be configured to be either zero (0) seconds "Delay 0S" or ten (10) seconds "Delay10S". The default value used by the Model 740 Monitor is ten (10) seconds.

Should it need to be changed, first enter the Configuration menu. Refer to Page 98, ENTERING THE CONFIGURATION MENU.

Once in the menu, use one of the NEXT programmed pushbutton keys until the Message Window displays the monitor's current setting for the SpO₂ Alarm Delay.

Use the ARROW UP or ARROW DOWN pushbuttons to make your selection.

Press one of the NEXT programmed pushbutton keys to advance onto the next menu or use the CANCEL pushbutton to exit to the "Ready" mode.

CASMED 740 Monitors

SETTING THE DATE

The CASMED 740 Monitor's Date value is set at the factory. Should it need to be changed, first enter the Configuration menu. Refer to Page 98, ENTERING THE CONFIGURATION MENU.

Once in the menu, use one of the NEXT programmed pushbutton keys until the Message Window displays the monitor's date using the following format: "DDMMMYY". Where DD = Day of the Month, MMM = Month of the Year (JAN, FEB, etc.) and YY = Last 2 digits of the year (2002 is displayed as 02). The flashing parameter indicates the parameter that can be changed.

Use the ARROW UP or ARROW DOWN pushbuttons to make your selection. Press one of the NEXT programmed pushbutton keys to advance to the next parameter to set within the Date menu.

Press one of the NEXT programmed pushbutton keys to advance onto the next menu or use the CANCEL pushbutton to exit to the "Ready" mode.

SETTING THE TIME

The CASMED 740 Monitor's Time value is set for Eastern Time and is set at the factory. Should it need to be changed, first enter the Configuration menu. Refer to Page 98, ENTERING THE CONFIGURATION MENU.

Once in the menu, use one of the NEXT programmed pushbutton keys until the Message Window displays the monitor's time using the following format: "TM HH:MM". Where HH = Hour of the Day (0 – 23) and MM = Minute of the Hour (0 – 59). The flashing parameter indicated the parameter that can be changed.

Use the ARROW UP or ARROW DOWN pushbuttons to make your selection. Press one of the NEXT programmed pushbutton keys to advance to the next parameter to set within the Time menu.

<p>NOTE:</p>

<p>Altering the Date and Time will affect the History readings, but not erase them.</p>

Press one of the NEXT programmed pushbutton keys to advance onto the next menu or use the CANCEL pushbutton to exit to the "Ready" mode.

DAYLIGHT SAVING TIME OPTION

The CASMED 740 Monitor can be configured to automatically respond to time changes associated with Daylight Saving Time. The monitor can be configured to one of five Daylight Saving Time Option settings. They are:

- **DST OFF** Daylight Saving Time is “OFF”. The user is responsible for changing the time if needed. This is the default setting for the CASMED 740 Monitor.
- **DST N AM** Daylight Saving Time “North America”. Use this setting and the monitor will automatically *add* one (1) hour the first Sunday in April at 2 a.m. and *subtract* (1) hour the last Sunday in October at 2 a.m.
- **DST EU 1, 2, 3** Daylight Saving Time “European Union”.

In the European Union, Daylight Saving Time begins and ends at 1 a.m. Universal Time (Greenwich Mean Time). It starts the last Sunday in March, and ends the last Sunday in October. In the EU, all time zones change at the same moment.

Select EU 1 if the monitor will be located in Ireland, Portugal or the United Kingdom. Select EU 3 for Finland. EU 2 can be used for all remaining countries within the European Union.

<p style="text-align: center;">NOTE:</p>

<p>Enabling Daylight Saving Time will affect the History readings, but not erase them.</p>
--

Should it need to be changed, first enter the Configuration menu. Refer to Page 98, ENTERING THE CONFIGURATION MENU.

Once in the menu, use one of the NEXT programmed pushbutton keys until the Message Window displays the monitor’s current setting for Daylight Savings Time.

Press one of the NEXT programmed pushbutton keys to advance onto the next menu or use the CANCEL pushbutton to exit to the “Ready” mode.

BATTERY POWER

The CASMED 740 Monitor is equipped with an internal rechargeable battery. The battery is charging whenever the monitor is plugged into a power source (AC Line Power or +12 VDC). A Battery Power Visual Indicator, located on the front panel, indicates the status condition of the monitor’s battery.

Batteries will self-discharge when they are not used. It is recommended that the battery be maintained at full charge by leaving the monitor connected to a power source whenever possible.

The standard 7.2 Volt 3700 mAh battery pack, when fully charged, is capable of taking 100 NIBP readings when the monitor is set in the 5-minute Automatic Mode.

CASMED 740 Monitors

When the message "Low Batt" appears in the Message Window, at least thirty (30) minutes of battery operation remain. The "Low Batt" message will alternate continuously with the "Ready" message to indicate that the battery should be charged as soon as possible. Also, the monitor's front panel Battery Power Visual Indicator will change from Orange to Red and three (3) audio "beeps" are heard every twenty-five (25) seconds.

WARNING:

Upon the detection of a Low Battery condition and if the battery is not charged by the user, the monitor may no longer function as intended. The monitor should be plugged into a power source as soon as possible and the battery allowed to charge for four (4) hours.

When the "Dead Bat" message appears, the battery is no longer able to power a measurement. The message "Dead Bat" is displayed continuously in the Message Window, the Battery Power Visual Indicator is colored Red and three (3) audio "beeps" followed by two (2) audio "beeps" once every ten (10) seconds are heard until the power is turned off.

WARNING:

Upon the detection of a Dead Battery condition and if the monitor is not turned off by the user, the monitor shuts down and turns "OFF" after three (3) minutes of operations.

When either of these messages appears, it is necessary to recharge the battery. A depleted battery may be fully recharged in four (4) hours. The monitor can be used to obtain measurements while the battery is charging.

NOTE:

Using the monitor while charging may lengthen the time to restore battery charge.

NOTE:

During charging of the battery, the case may feel warm to the touch.

CHECKING BATTERY STATUS

NOTE:

If your CASMED 740 Monitor is not equipped with a Smart Pack battery, the monitor, when connected to a power source (AC Line Power or +12 VDC) and is powered "OFF", will display "Charging" in the Message Window until the battery reaches a full charge condition. Once the battery reaches full charge, the monitor is capable of supplying battery charge information as described in items 1, 2 and 3 below.

If your CASMED 740 Monitor is equipped with a Smart Pack battery, the following applies:

The monitor's Main Board receives information from electronics enclosed within the battery pack. The status of the battery pack can be verified using one of the following methods:

- 1) When the monitor is connected to a power source (AC Line Power or +12 VDC) and is powered "ON", press and hold the SILENCE/RESET pushbutton for two (2) seconds. The monitor will display in the Message Window, for as long as the button is pressed, "XXX % CHG", where "XXX" represents the percent (0 to 100) of the full charge condition of the battery.
- 2) When the monitor is connected to a power source (AC Line Power or +12 VDC) and is powered "OFF", the Message Window will display "XXX % CHG", where "XXX" represents the percent (0 to 100) of the full charge condition of the battery.
- 3) When the monitor is running on battery power and is powered "ON", press and hold the SILENCE/RESET pushbutton for two (2) seconds. Based on the revision of the Control Board software installed in the monitor, one of the following will apply;
 - a) If your CASMED 740 Monitor has Control Board software Version 1.1, 1.2, or 1.3 installed, the Message Window will display the "Estimated Battery Run Time" remaining for as long as the button is pressed in one of formats listed below;
 - If less than one-half hour is available, the Message Window will display "<.5 hrs".
 - If greater than one-half hour is available, the Message Window will display time in hours (.5, 1, 1.5, 2, 2.5 etc).
 - If more than ten (10) hours is available, the Message Window will display ">10 hrs".
 - b) If your CASMED 740 Monitor has Control Board software Version 1.4 or greater installed, the Message Window will display "XXX % CHG", where "XXX" represents the percent (0 to 100) of the full charge condition of the battery for as long as the button is pressed.
- 4) The CASMED 740 Monitor's Battery Pack may contain on-board electronics, which can be used to check the status of battery charge remaining when not connected to the monitor. If available, press the pushbutton located on the inside panel of the battery pack. Once pressed, four (4) LED indicators will illuminate to display the status of battery charge remaining (each LED lit is equivalent to approximately 25%).

CASMED 740 Monitors

CAUTION:

This product contains a rechargeable battery that is recyclable. Under various state and local laws, it may be illegal to dispose of this battery into the municipal waste stream. Check with your local authorities for instructions on recycling options in your area.

AUTO OFF FEATURE

The CASMED 740 Monitor incorporates an Auto “OFF” feature to preserve battery life. The Auto Off feature is enabled automatically when the user selects the “Alrm Off” option in the Configuration Menu.

When the monitor is in this mode and if accidentally left powered “ON” for ten (10) minutes without any key presses or any parameters active, the monitor will beep for five (5) seconds prior to automatically shutting itself down to preserve battery life.

For the Auto “OFF” feature to work properly, the following conditions must apply;

- “Alrm Off” is selected in the Configuration Menu.
- The CASMED 740 Monitor is operating on battery power.
- No NIBP, SpO₂ or Temperature readings were taken in the past ten (10) minutes.
- No key presses were made in the past ten (10) minutes.
- The monitor cannot be in the Automatic NIBP cycle mode.

POWER FAIL

The CASMED 740 Monitor incorporates a Power Fail feature. Whenever the power is disconnected from the monitor and the monitor is not allowed to shut down in an orderly fashion, the monitor, when re-powered alerts the user. The message “Pwr Fail” is displayed in the Message Window and three (3) audio “beeps” followed by two (2) audio “beeps” are heard every ten (10) seconds.

During this condition, all other pushbuttons are inactive except for the ON/STANDBY and SILENCE/RESET.

To clear the Power Fail condition, and return to “Ready”, press the SILENCE/RESET pushbutton or recycle the monitor’s power.

USER MESSAGES

The CASMED 740 Monitor displays a variety of messages to aid the user in monitor operation. If a troubleshooting message is displayed during a measurement, follow the actions listed to correct the situation.

If the monitor does not turn on, or exhibits a flashing display and failure to operate, the battery is most likely below the Dead Battery point. Connect the monitor to a power source (AC Line Power or +12 VDC) and allow it to charge for four (4) hours.

Refer to Table 8: Error Messages on the Message Window for more information.

If the monitor is in need of repair, it must be referred to the appropriate service personnel. Service performed by unauthorized personnel could be detrimental to the monitor and will void the warranty. For service, contact your dealer or CAS Medical Systems, Inc.

SpO₂ USER MESSAGES

(available if SpO₂ is installed)

If the accuracy of any measurement does not seem reasonable, first check the patient's vital signs by an alternate method.

NOTE:

The SpO₂ probe must be kept as motionless as possible to make a proper determination. Use the SpO₂ strength bar graph to determine if a strong rhythmic pulse signal is present.

When no oximeter probe is attached to the monitor, the %SpO₂ window and signal strength window will be blank. When no SpO₂ pulse data is available, the monitor will display the last NIBP pulse.

When the probe is connected to the monitor, but is off of the patient, the message “—” is displayed in the %SpO₂ and Pulse Rate windows. The Message Window flashes the message “Prb OFF” and three (3) audio “beeps” are heard every twenty-five (25) seconds.

Press the SILENCE/RESET pushbutton. The monitor silences the audible alarm tone, but the message remains.

If the message “Prb” should appear in the %SpO₂ window, verify that the probe being used is the correct one for the monitor's SpO₂ configuration (Masimo, Nellcor, Nonin) or that the probe is not defective.

Press the SILENCE/RESET pushbutton. The monitor silences the audio alarm tone, but the message remains. Remove the defective probe and replace it with a working probe.

Each sensor is designed for a specific clinical application.

NOTE:

Inaccurate measurements may be caused by:

- anemia or low hemoglobin concentrations
- electro-surgical interference
- excessive ambient light
- excessive patient movement
- incorrect sensor application or use
- intravascular dyes such as indocyanine green or methylene blue
- moisture in the sensor
- placement of a sensor on an extremity with a blood pressure cuff, arterial catheter, or intravascular line
- venous pulsations

CASMED 740 Monitors

NOTE:

The loss of a pulse signal can occur in any of the following situations:

- a blood pressure cuff is inflated on the same extremity as the one with the SpO₂ sensor attached
- excessive ambient light such as from a surgical lamp, a bilirubin lamp, or sunlight
- the patient has hypotension, severe vasoconstriction, severe anemia, or hypothermia
- the patient is in cardiac arrest or is in shock
- the sensor is too tight
- there is arterial occlusion proximal to the sensor

If the SpO₂ Module located inside the CASMED 740 Monitor should fail, the message “Err” will appear in the %SpO₂ display window.

Press the SILENCE/RESET pushbutton. The monitor silences the audio alarm tone, but the message remains.

Should any of the above problems persist, contact your dealer or CAS Medical Systems, Inc.

TEMPERATURE FUNCTION USER MESSAGES

If the probe becomes unattached to the CASMED 740 Monitor’s rear panel connector, the message “Prb” is shown in the TEMP display window.

NOTE:

Press the SILENCE/RESET pushbutton to clear the TEMP display.

If the Temperature probe well is removed from the top of CASMED 740 Monitor’s Temperature module, the message “Prb” is shown in the TEMP display window.

NOTE:

Press the SILENCE/RESET pushbutton to clear the TEMP display.

When an attached probe is removed from the probe holder, the message OrL, ALy or rEC is shown briefly in the TEMP display window indicating the predictive algorithm is being used by the Temperature function.

When the message “Err XX”, where “XX” is an Error Number, is displayed in the TEMP display window an error condition has occurred and a reliable temperature reading could not be obtained.

NOTE:

Press the SILENCE/RESET pushbutton to clear the TEMP display.

Refer to Table 6: SureTemp® Temperature Error Codes or Table 7: SureTemp Plus® Temperature Error Codes for more information.

Verify the monitor’s operating environment is within its limits and start the procedure from the beginning.

ERROR	CLASS	ERROR DESCRIPTION
00		Transmit buffer overflow
01	Probe	Probe heater energy accumulation too high
02	Probe	Probe a/d pulse width out of range
03	Probe	Adaptive probe gain too high or too low
11	Ambient	Ambient temperature above 104 °F
12	Ambient	Ambient temperature below 60.8 °F
21	Module	Battery voltage below error threshold of 3.0 volts
31	Module	RAM read/write error
32	Module	ROM checksum error
33	Module	CPU instruction error
40	Module	PTB resistor a/d pulse width out of range
41	Module	RatioCal resistor a/d pulse width out of range
42	Module	External ambient thermistor a/d pulse width out of range
50	Module	Heater circuit failure
51	Module	Probe heated above 112 °F
52	Module	Heater watchdog timeout failure
60	Module	PTB resistor "temperature" out of rang
99	Configuration	Temperature option no longer recognized

Table 6: SureTemp® Temperature Error Codes

Should any of these problems persist, contact your dealer or CAS Medical Systems, Inc.

ERROR	CLASS	ERROR DESCRIPTION
21	Probe	Defective probe tip where heater is too close to thermistor
22	Probe	Excessive heater energy, heater not working
24	Ambient	Ambient temperature too high
25	Ambient	Ambient temperature too low
27	Voltage	Power Supply voltage exceeds algorithm max value
28	Voltage	Power Supply voltage below algorithm min value
32	Probe	Thermistor pulled away from the tip or heater broken
33	Probe	Probe not responsive, not characterized/calibrated
34	Probe	Probe not characterized/calibrated
45	Prb/Mod/Pat ¹	Measurement below allowable temperature values
46	Prb/Mod/Pat	Measurement above allowable temperature values
47	Module	Internal calibration resistor in module is damaged
48	Module	Internal calibration resistor in module is damaged
49	Module	Internal circuit validation resistor in module is damaged
50	Module	Internal circuit validation resistor in module is damaged
51	Module	A/D measurement timed out
52	Probe	Probe not characterized/calibrated
59	Voltage	Power Supply voltage below algorithm max value

¹ Prb/Mod/Pat indicates class could Probe, Module or Patient

CASMED 740 Monitors

ERROR	CLASS	ERROR DESCRIPTION
60	Voltage	Power Supply voltage exceeds algorithm min value
61	Module	Reference voltage under voltage or unstable
65	Module	Problem saving to the Module's EEPROM
66	Module	Module or Probe error detection mechanism error
67	Module	Problem reading or saving to Module's EEPROM
68	Module	Problem reading or saving to Module's EEPROM
69	Module	Problem reading or saving to Module's EEPROM
70	Probe	Problem reading the probe's EEPROM
74	Module	Internal Error, EEPROM not initialized
75	Probe	Cannot read probe's EEPROM correctly
80	Module	Problem with turning probe heater off
81	Module	Problem with turning probe heater on
82	Module	Internal error
83	Module	Internal error
84	Module	Internal error
85	Module	Heater hardware fail safe error

Table 7: **SureTemp Plus® Temperature Error Codes**

Should any of these problems persist, contact your dealer or CAS Medical Systems, Inc.

ERROR MESSAGES ON THE MESSAGE WINDOW

ERROR MESSAGE	POSSIBLE CAUSE	POSSIBLE SOLUTION
"Air Leak"	Air leak in cuff/hose/monitor pneumatic system.	Check that the cuff/hose/monitor connection is secure. Check cuff for leaks. Do not use a known leaky cuff.
"Appl Err"	Neonate cuff is detected in Adult Mode.	Check cuff. Replace cuff or change operating mode
"Chk Prb" (Masimo)	The monitor is questioning the quality of the signal being received by the SpO ₂ sensor. The sensor is receiving too much ambient light.	Verify that the sensor is being used according to the manufacturer's recommendations. Verify that the sensor emitter and detector are parallel to and directly opposing each other.
"ChksumEr"	An electronic failure has occurred within the monitors' Main Control Board.	Contact CAS Medical Systems to have the monitor serviced.
"Dead Bat"	The battery is fully discharged.	Recharge the battery for at least 4 hours.
"Flow Err"	Stable cuff pressure cannot be maintained by the pneumatic system.	Check the external tube for kinks. Perform a Pneumatic Check as detailed in the Maintenance section of this manual. Replace cuff.
"LooseCuf"	Cuff applied too loosely.	Check cuff for proper fit on patient.
"Low Batt"	The battery is almost discharged.	At least 30 minutes of operation is available from when the message first appears. Recharge the battery as soon as possible.
"Low Perf" (Masimo)	The perfusion level being received by the SpO ₂ sensor is low.	Determine if an extreme change in the patient's physiology and blood flow at the monitoring site occurred (e.g. an inflated blood pressure cuff, a squeezing motion). Try to warm the patient or sensor site. Move sensor to a site with better perfusion.

Table 8: Error Messages on the Message Window

CASMED 740 Monitors

ERROR MESSAGES ON THE MESSAGE WINDOW (cont.)

ERROR MESSAGE	POSSIBLE CAUSE	POSSIBLE SOLUTION
"Motion"	There was too much extremity motion for the monitor to accurately complete the NIBP measurement in 120 seconds.	Measurements can be obtained when there is limited extremity movement, but the measurement time may be extended. Measurement time is limited to 120 seconds. Restrain patient extremity motion.
"NBP Cal"	Pressure calibration data corrupted within NIBP module.	Pressure module needs recalibration. Contact CAS Medical Systems to have the monitor serviced.
"NIBP Err"	An electronic failure has occurred within the NIBP module.	Contact CAS Medical Systems to have the monitor serviced.
"No Probe"	The monitor is not detecting the SpO ₂ probe.	The probe was disconnected from either the Interface Cable or from the monitor.
"OverPres"	Cuff pressure exceeded 290 mmHg in the Adult mode or 145 mmHg in the Neonatal mode.	Very rapid squeezing of the cuff can cause this error. Repeat the measurement. If this message repeatedly occurs during normal use, the monitor must be serviced.
"P Search"	The monitor is searching for a Pulse signal.	Normal at power-up as the monitor searches for a pulse. The probe position may have changed. Check the probe site.
"Prb OFF"	The monitor is no longer receiving a patient signal from the SpO ₂ probe.	The probe is no longer in contact with the patient. Check the probe site.
"Pwr Fail"	Power was disconnected from the monitor.	Press the SILENCE/RESET pushbutton to clear the message. OR Re-cycle the monitor's power.

Table 8: Error Messages on the Message Window

ERROR MESSAGES ON THE MESSAGE WINDOW (cont.)

ERROR MESSAGE	POSSIBLE CAUSE	POSSIBLE SOLUTION
"RangeErr"	The systolic reading exceeds the measurement range of 255 mmHg in the Adult mode or 135 mmHg in the Neonatal mode.	Repeat measurement. If the message is displayed again, use another method to measure the patient's blood pressure.
"SetClock"	The monitor's clock needs to be set.	The monitor's time and date values are incorrect. Refer to Page 104, for information to set the Time and Date. The monitor's internal clock battery needs to be replaced. Contact CAS Medical Systems.
"Signal ?" (Masimo)	The quality of the signal level being received by the SpO ₂ sensor is in question.	Ensure proper sensor type and application. Verify that the sensor emitter and detector are parallel to and directly opposing each other. Clean or replace the sensor.
"Sig Sat"	Motion pulses too strong.	Limit patient activity; the arm must be still and/or relaxed. Repeat measurement.
"Sys Err"	An electronic failure has occurred within the monitor.	Contact CAS Medical Systems to have the monitor serviced.
"Time Out"	The monitor was unable to complete a measurement within 120 seconds in the Adult mode or 90 seconds in the Neonatal mode.	An extremely long measurement can be due to a loose cuff, high blood pressure, or monitor re-pumps. Try measurement again. Try higher initial pressure. If message consistently reappears try using another means to obtain patient's blood pressure.
"Weak Sig"	The monitor did not detect any pulses during a NIBP measurement.	Check the fit of the cuff. Repeat measurement.

Table 8: Error Messages on the Message Window

This page is intentionally left blank

Section 9

External Printer

9. EXTERNAL PRINTER

The following section is provided as an overview of the Citizen CMP-10 Mobile Printer as it is used with the CASMED 740 Monitor.

NOTE:

The Citizen Model CMP-10 Mobile Printer that is used with the CASMED 740 Monitor has proprietary software installed in it for communications.

NOTE:

For more detailed information on the Citizen Model CMP-10 Mobile Printer, refer to the User's Manual that was supplied with the printer.

WARNING:

The CASMED 740 Monitor has been tested with the Citizen CMP-10 Mobile printer to comply with IEC 60601-1-1 and is the only printer that is recommended to be used with the monitor. If another printer is to be used, the user must read the Warning on Page 40 under LEAKAGE CURRENT TEST and follow the guidance given.

PRINTER OVERVIEW

The Citizen CMP-10 Mobile Printer interfaces to the CASMED 740 Monitor via an infrared IrDA port or by using the direct connect RS232 cable (supplied with printer). The IrDA ports are located on the top of the printer and on the bottom front panel of the CASMED 740 Monitor.

When using the IrDA port, it is important to keep the two devices close together (less than three (3) feet/one (1) one meter) and in-line to maintain proper communications.

CAUTION:

For safe and proper usage of the external printer, please observe the following:

When using the printer:

- Avoid placing monitor in areas where fluid may enter the printer opening accidentally.
- Do not drop or bump the monitor.
- Avoid places subject to high or low temperature extremes.
- Avoid direct sunlight.
- Avoid dusty places and where corrosive gasses are generated.
- Never attempt to dismantle or repair the printer mechanism.

When handling the thermal paper:

- Store in a dark, cool and dry place.
- Do not place near organic solvents.
- Avoid contact with vinyl chloride films erasers or adhesive tapes for extended periods.
- Avoid exposure to high temperature, humidity, liquid, or sunlight.
- Always use specified thermal paper (CAS P/N 28-02-0077).

PRINTER CONTROLS AND INDICATORS

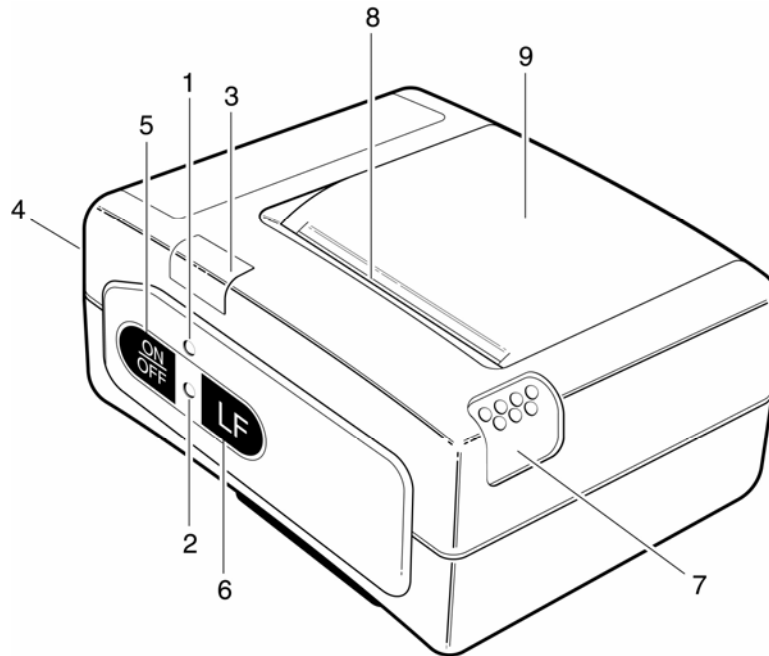

Figure 20: **Printer Controls and Indicators**

- LED Indicators (Bicolor – Red and Green)
 1. CHARGE LED
Red on – Charging Battery
Green on – Battery is fully charged
 2. Power (Error) LED
Green on – Device is switched “ON” or self-testing is in progress
Red/Green blinking fast - End of paper
Red/Green blinking slow - Print Head Overheated
- Controls
 3. Infrared (IrDA) port
 4. RS 232 Serial Port
 5. Power ON/OFF switch
 6. Line Feed button
press once for one (1) line paper feed
press down and hold for continuous paper feed to any length
 7. Paper Cover Release Button - Press down to open cover
 8. Paper Cutting Edge
 9. Paper Cover

PRINTER OPERATION

DIRECT CONNECTION

The monitor uses the DB9 connector, located on the rear panel of the monitor to interface to the RS232 port on the printer. Use the cable which is supplied with the printer.

NOTE:

When using the direct connect method, connect the printer's serial cable to the printer before turning the printer on.

INFRARED CONNECTION

NOTE:

When using the infrared port, disconnect the printer's serial cable from the printer before turning the printer on.

Position the printer's IrDA port window in-line with the IrDA window of the CASMED 740 Monitor OR connect the RS232 direct cable from the printer to the 9-pin RS 232 connector, located on the rear panel of the CASMED 740 Monitor.

NOTE:

When using the IrDA port for printing, it is recommended to keep all items clear of the communications path between the monitor and the printer.

Turn the printer "ON". To turn the printer "ON", press and hold the ON/OFF pushbutton for one (1) second. The Power LED illuminates Green.

To turn the printer "OFF", press and hold the ON/OFF pushbutton. The Power LED will illuminate Red and change back to Green. When the LED illuminates Green, remove your finger from the pushbutton.

NOTE:

If the printer was powered "ON" during the monitor's power-up sequence, the CAS Medical Systems logo is printed.



The CMP-10 Mobile Printer contains an Auto Power Off feature. If the monitor and printer become separated and after ten (10) minutes during which no data has been sent to the printer and the Line Feed (LF) pushbutton has not been pressed, the printer will automatically shutoff.

The CASMED 740 Monitor will periodically send to the printer a "wake-up" message that will disable the Auto Power Off feature.

CASMED 740 Monitors

Sample printouts of both History Modes are shown below.

740X Series Monitor
04-Oct-06 13:56

Patient: _____

Notes: _____

Events:

Hr:Mn	Sys	Dia	MAP	Pls	%O2	Temp
13:57	112	78	89	72	***	****
13:59	115	77	88	60	98	****
14:01	117	78	90	70	***	****
14:01	120	80	100	65	***	****
14:03	118	78	91	77	98	****
14:04	***	***	***	***	***	37.0°C

740X Series Monitor
04-Oct-06 15:02

Patient: _____

Notes: _____

Events:

Hr:Mn	Sys	Dia	MAP	Pls	%O2	Temp
15:04	112	78	89	72	***	****
15:09	115	77	88	60	98	****

740X Series Monitor
04-Oct-06 13:56

Patient: _____

Notes: _____

Trends:

Hr:Mn	Sys	Dia	MAP	Pls	%O2	Temp
13:57	112	78	89	72	***	****
13:59	115	77	88	60	98	****
14:00	***	***	***	64	99	****
14:01	117	78	90	70	***	****
14:01	120	80	100	65	***	****
14:03	118	78	91	77	98	****
14:04	***	***	***	***	***	37.0°C

740X Series Monitor
04-Oct-06 15:02

Patient: _____

Notes: _____

Trends:

Hr:Mn	Sys	Dia	MAP	Pls	%O2	Temp
15:04	112	78	89	72	***	****
15:09	115	77	88	60	98	****

Figure 21: Sample Printouts

NOTE:

When no patient information is stored in the Trend History, for consecutive minute storage, a break appears in the Trends printout. If the %O2 reading is "****", then the Pulse value (Pls) shown is associated with the NIBP reading.

CHARGING THE PRINTER BATTERY

The CMP-10 Mobile Printer is equipped with a rechargeable Lithium Ion (LiION) battery pack.

When the printer detects a Low Battery condition within itself, the message “Low Battery” is printed and an audio indicator, located inside the printer sounds three (3) times.

WARNING:

Charge the printer battery using the AC Adapter, Model TRC-09-1100-M from GROUP WEST, or equivalent, included with the printer.

Plug the battery charger’s cord into the printer battery charger jack, located on the rear panel. Plug the charger into an AC wall outlet of the appropriate voltage. Verify the CHARGE LED indicator is lit Red. Battery charge time is approximately three (3) hours. Once the battery is fully charged, the CHARGE LED indicator switches to Green.

INSTALLING PAPER

NOTE:

A red line appears when the remaining supply of thermal paper becomes low.

- 1) Switch the printer “OFF”.
- 2) Press the Cover Open button to access the paper compartment. Remove any remaining paper before installing the new roll.
- 3) Place the new paper roll as shown on the illustration and pull out enough paper to reach out over the control panel of the printer.
- 4) Close the paper door.

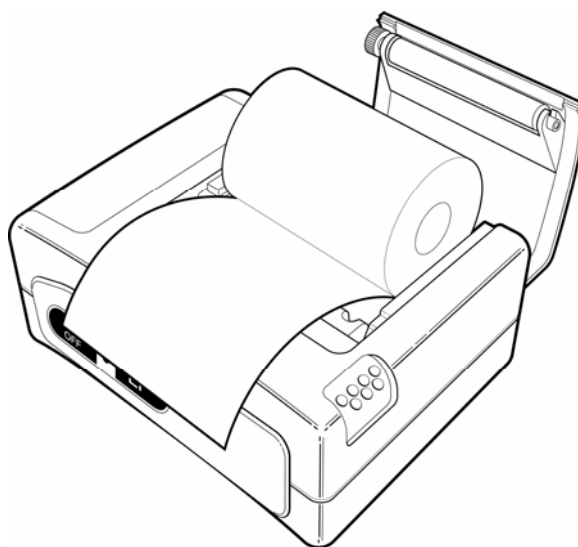

Figure 22: Paper Installation

CASMED 740 Monitors

NOTE:

Make sure that the paper is correctly placed. If it is tilted in one or another direction and does not come out straight from under the cover, open the door and reposition the roll again.

WARNING:

Do not touch the print head or paper cutter while replacing the printer paper.

REPLACING THE BATTERY PACK

WARNING:

Do not operate the printer or connect the printer to the CASMED 740 Monitor with the battery pack removed.

WARNING:

Never change the battery pack while the battery charger is plugged in and/or the CASMED 740 Monitor is being operated.

- 1) Switch the printer "OFF".
- 2) Disconnect the printer from the CASMED 740 Monitor and unplug the wall charger cord.
- 3) Open the battery door by pressing in on the battery cover and pushing upward.

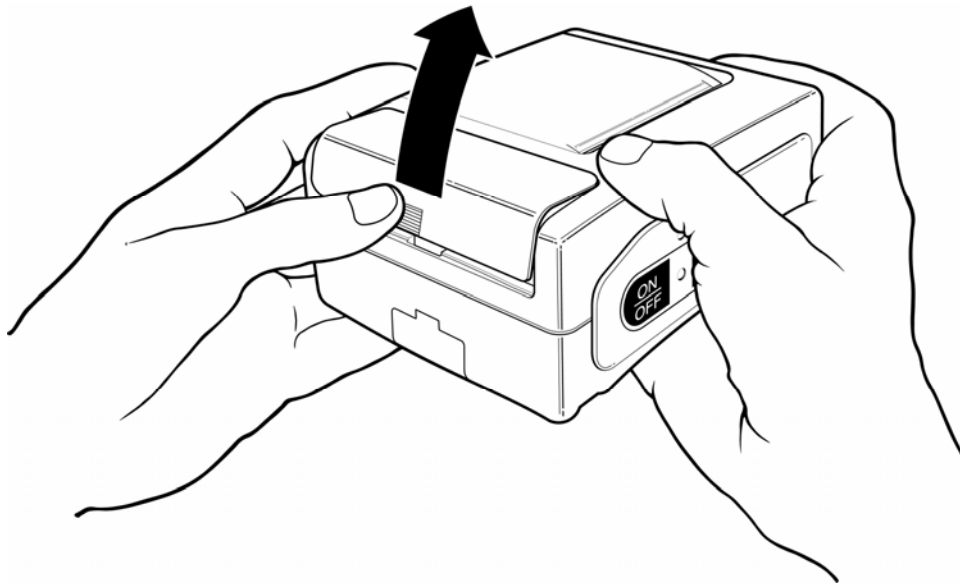

Figure 23: **Opening the Battery Door**

- 4) Remove the battery cover.
- 5) Remove the battery pack from the compartment and disconnect its connecting cable.

INSTALLING A NEW BATTERY PACK

- 1) Connect the battery cable into the battery connector.
- 2) Insert the battery and its connecting cable into the battery compartment.

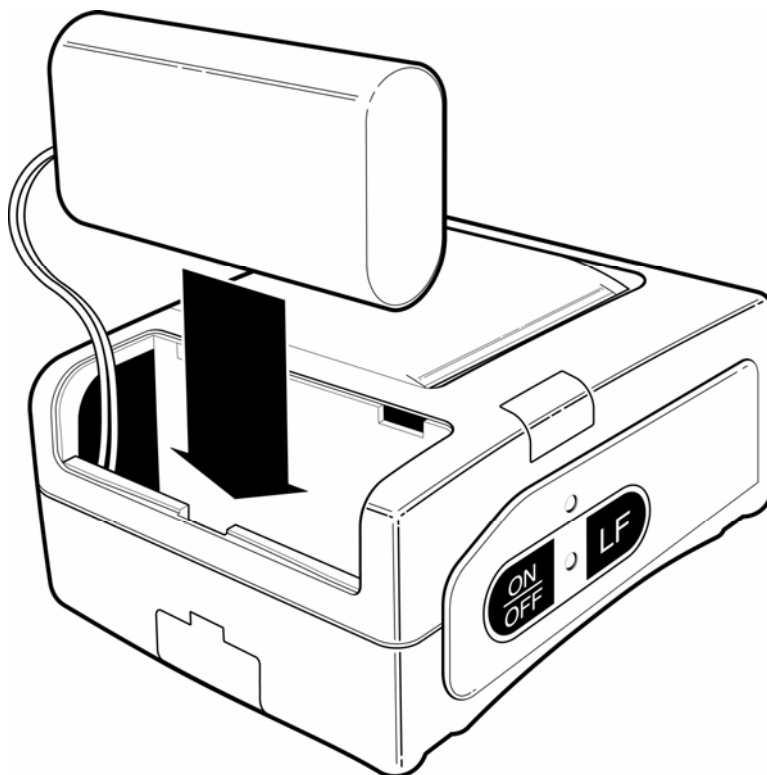

Figure 24: **Installing the New Battery**

- 3) Replace the battery cover by sliding it in from the back of the printer and pushing down to lock it in place.

CAUTION:

Be sure to place the battery cover firmly in its position after installing the new battery pack.

WARNING:

Do not disassemble the battery pack or batteries. The batteries contain electrolytes, which can cause injury to eyes, skin and clothing.

NOTE:

This product contains a rechargeable battery that is recyclable. Under various state and local laws, it may be illegal to dispose of this battery into the municipal waste stream. Check with your local authorities for instructions on recycling options in your area.

This page is intentionally left blank

Section 10

Cleaning

10. CLEANING

CLEANING OVERVIEW

WARNING:

Do not, under any circumstances, perform any testing or maintenance on the monitor while the monitor is being used to monitor a patient. The monitor must be turned "OFF". Unplug the monitor from the AC power source and remove the internal battery.

CAUTION:

Do not open the monitor to clean or repair it. Contact CAS Medical System for service needs.

CAUTION:

Disconnect all accessories from the monitor before cleaning. Do not immerse any part of the electrical connector of the cable or accessories in the cleaning or disinfection solution at any time. Do not use an abrasive cloth or cleaner on the accessories.

THE MONITOR

On a daily basis, examine the monitor's case for any damages and check the AC power cord for bent or broken prongs, cracks or fraying. Neither the monitor nor the power cord should be used if damaged. If any damage is noted, contact the appropriate service personnel.

CAUTION:

Do not spray any water or cleaning solution directly onto the monitor.

As needed, clean the monitor using a soft cloth dampened with a mild dishwashing detergent solution and gently rub the soiled area until clean. Use a clean soft cloth to dry the monitor. Do not use abrasive cleaners on the monitor. Do not use either isopropyl alcohol or solvent to clean the monitor. Use of these cleaners can cause damage to the monitors' surface. Do not immerse the monitor or power cord in the cleaning solution.

When necessary, the monitor surfaces may be disinfected using a soft cloth saturated with a 10% (1:10) solution of chlorine bleach in tap water. When all of the surfaces have been disinfected, wipe the entire surface of the monitor using a soft cloth dampened with fresh water to remove any trace amounts of residue and/or fumes.

NOTE:

Thoroughly wipe off any excess cleaning solutions. Care should be taken to prevent water or cleaning solution to run into connector openings or crevices.

CASMED 740 Monitors

THE DISPLAY

CAUTION:

Use care when cleaning the display. Scratches may occur.

Occasionally, as needed, clean the display window using a soft, lint-free cloth sprayed with an alcohol free glass cleaner. Do not use either isopropyl alcohol or solvent to clean the display. Use of these cleaners can cause damage to the display. The use of paper towels is not recommended as it may scratch the surface.

CUFFS

NOTE:

Refer to the product packaging for additional Cleaning and Disinfecting Instructions were applicable.

Prior to each patient use, inspect the blood pressure cuff and its hose for damage.

CAUTION:

If the cuff should become grossly contaminated with blood or other bodily fluids, it should be discarded.

NOTE:

CAS does not recommend submersion of the cuff. Liquid should not be permitted to enter the cuff bladder because instrument damage may occur. The cuff should be allowed to thoroughly dry before use.

TUFF-CUFF

As necessary, clean the blood pressure cuff using a soft cloth dampened with a 70% Isopropyl Alcohol solution. The cuff should be allowed to thoroughly dry before use.

SAFE-CUFF

As necessary, clean the cuff using a soft cloth dampened with a soap, water-based detergent or chlorinated disinfectant solution. Do not use alcohol.

SOFTCHECK

These cuffs are designed for single patient use, and are not to be reprocessed.

ULTRACHECK

As necessary, for normal cleaning with mild detergents / dilute bleach solution (1-2%), wipe the cuff with the cleaning solution, rinse with water and dry.

PNEUMATIC TUBING

CAUTION:

If the hose should become grossly contaminated with blood or other bodily fluids, it should be discarded.

NOTE:

CAS does not recommend submersion of the hose. Liquid should not be permitted to enter the hose because instrument damage may occur. The hose should be allowed to thoroughly dry before use.

Prior to each patient use, inspect the NIBP Inflation Hose for proper connection, cracks and kinks. As necessary, clean the pneumatic tubing using a soft cloth dampened with a germicidal solution.

PRINTER

When the printer becomes dirty, wipe with a soft dry cloth. For extreme dirt buildup, soak a cloth with mild detergent, wring well and wipe. Dry by wiping with a soft dry cloth.

CAUTION:

Before cleaning the printer, disconnect the AC adapter from the printer.
Do not use volatile chemicals such as thinner, benzine, etc.
Never wet the inside of the printer mechanism.

Refer to the printer User's Manual for more information.

SpO₂ INTERCONNECT CABLE

Prior to each patient use, inspect the SpO₂ Interconnect cable for damage. As necessary clean the cable using a soft cloth dampened with a germicidal solution.

SpO₂ SENSORS

(Reusable)

As necessary, the sensor may be surface cleaned by wiping it with a 70% isopropyl alcohol pad. Allow the sensor to dry prior to placement on a patient.

CAUTION:

Do not soak or immerse the sensor or its cable in any liquid solution. Do not attempt to sterilize.

Refer to the Directions For Use pamphlet enclosed with each sensor for more information.

CASMED 740 Monitors

TEMPERATURE PROBES

CAUTION:

Do not soak or immerse the probe or its cable in any liquid solution. Do not attempt to sterilize.

The temperature probe should periodically be cleaned by wiping with an alcohol dampened cloth or wipe, warm water, or properly diluted non-staining disinfectant.

PROBE WELL (SureTemp Plus)

CAUTION:

Do not use hard or sharp objects to clean the probe well. This could damage the probe well and cause the unit to not function properly.

Do not use steam, heat or gas sterilization on the probe well. Do not autoclave the probe well.

As necessary, clean the inner and outer surfaces of the probe well by swabbing the surface with a cloth dampened with a mild detergent solution or a 70% isopropyl alcohol, or a 10% chlorine bleach solution, or a non-staining disinfectant.

NOTE:

Thoroughly dry all surfaces before re-assembling the monitor.

Section 11

Maintenance

11. MAINTENANCE

MAINTENANCE INTERVALS

Preventive maintenance of the monitor is an important function that should be performed routinely by the user to ensure safe and efficient monitor operation. CAS Medical Systems recommends that you do the following:

- Perform a pneumatic check every six (6) months.
- Perform a calibration check once per year or when there is doubt about the validity of the pressure readings.
- Replace the battery pack every two (2) years.



If the monitor is in need of repair, it must be referred to the appropriate service personnel. Service performed by unauthorized personnel could be detrimental to the monitor and may void the warranty. For service, contact your dealer or CAS Medical Systems, Inc.

TEST MODE

The monitor must be in the Configuration Menu in order to perform the following functions:

- All LEDs “ON” Check
- Calibration Check
 - System Pressure
 - Over Pressure
- Pneumatic Pressure Checks
- Temperature Calibration Check

ENTER THE TEST MODE

To enter the monitor’s Configuration Menu, press and hold the VOLUME  and ALARM LIMITS  pushbutton keys while the monitor is being turned “ON” .

Once in the menu, press one of the PREVIOUS (CYCLE TIME / ALARM LIMITS) programmed pushbutton keys until the Message Window briefly displays “TestMode” followed by “0 mmHg”.

NOTE:

While in the Test Mode if no pushbutton is pressed within 15 minutes, the monitor will automatically terminate the Monitor Configuration menu and return to the “Ready” mode.

WARNING:

Do not place the monitor in the TEST MODE when a cuff is attached to a patient.

CASMED 740 Monitors

EXIT THE TEST MODE

When you have completed with the Test Mode, press the CANCEL pushbutton to exit. The Message Window will briefly display "Saving" and return to the "Ready" state.

LED CHECK

The CASMED 740 Monitor incorporates an all lights "ON" check to verify the functionality of the front panel LED displays and indicators.

Enter the Test Mode. Refer to Page 135, ENTER THE TEST MODE. The Message Window will briefly display "TestMode" followed by "0 mmHg".

Press and hold either the ARROW UP or ARROW DOWN pushbuttons. The monitor will illuminate all appropriate 7-segment displays, bar graph, bell icon and patient mode indicators for as long as the button is pressed.

CALIBRATION CHECK

Verify the calibration of the monitor once (1) per year.

A Calibration Kit, (product #P9) is included with the monitor. The kit contains a T-connector with a male and a female luer fitting (for a Calibration Check) and a male luer plug (to be used for the Pneumatic Check).

Obtain a mercury manometer whose accuracy meets the AAMI/ANSI Standard for Non-Automated Sphygmomanometers, 2002.

NOTE:

Monitor must be in the Adult mode prior to performing these pressure checks.
--

SYSTEM PRESSURE

Assemble the Calibration Kit according to the diagram provided in the P9 kit.

- 1) Remove the manometer tubing from the inflation bulb. Connect the open ended tubing of the T-connector to the inflation bulb.
- 2) Connect the female luer fitting to the inflation tube leading to the manometer.
- 3) Connect the male luer fitting to the manometer tubing.
- 4) Enter the Test Mode. Refer to Page 135, ENTER THE TEST MODE. The Message Window will briefly display "TestMode" followed by "0 mmHg".
- 5) Use the manometer inflation bulb to slowly inflate the system pausing for 30 seconds at the following points and verify calibration according to the following table:

0 mmHg +/- 1 mmHg
50 mmHg +/- 4 mmHg
100 mmHg +/- 4 mmHg
150 mmHg +/- 4 mmHg
200 mmHg +/- 5 mmHg

NOTE:

If the monitor does not display the test pressure for the 30-second period, deflate to zero and verify the proper assembly of the calibration set-up. Re-inflate the system. If the monitor again fails to hold the pressure, it is recommended the monitor be returned to CAS Medical Systems for service.

OVERPRESSURE

Inflate the pressure slowly until 290 mmHg +/- 10 mmHg is reached. The Message Window should stop updating, display the message "OverPres" and provide a NIBP Application Error audible tone.

Press the CANCEL pushbutton to exit the Overpressure Test. The monitor returns to the Calibration Check function.

If the monitor does not meet the above specifications, it is recommended the monitor be returned to CAS Medical Systems for service.

PNEUMATIC PRESSURE CHECKS

Check the monitor's pneumatic system for air leakage every six (6) months.

PLUG TUBE

Obtain the male luer plug found in the Calibration Kit (product #P9) supplied with the monitor.

- 1) Place this plug into the cuff connector at the end of the monitor inflation hose and twist one-quarter turn. The plug must fit securely into the connector for this test to be performed properly.
- 2) Enter the Test Mode. Refer to Page 135, ENTER THE TEST MODE. The Message Window will briefly display "TestMode" followed by "0 mmHg".
- 3) Press the NIBP START pushbutton to begin the Pressure Check.
- 4) The Message Window will display "Chk Prs", will inflate to approximately 180 mmHg and attempt to hold this pressure. The pressure value will be displayed in the SYSTOLIC display window. This test takes about fifteen (15) seconds.

CASMED 740 Monitors

- 5) At the completion of a successful Pressure Check, the Message Window will display "Passed", the monitor will beep two (2) times and will return to the Calibration Check function after five (5) seconds.
- 6) If the monitor fails the Pressure Check, the Message Window will display "Leak", the monitor will beep three (3) times and the return to the Calibration Check function after five (5) seconds.

Due to the volume differences of the hoses offered with the CASMED 740 Monitor, the monitor may incorrectly fail the Plug Tube check. Should the monitor fail the Plug Tube Pressure Check, obtain a 500 ml Pressure Cylinder and follow the 500 ml Pressure Check.

500 ml PRESSURE CHECK

Obtain a fixed volume 500 ml Pressure Cylinder (CAS p/n 01-02-0248).

- 1) Place the end of the monitor's inflation hose securely onto the luer fitting at the top of the pressure cylinder. The hose must fit securely onto the connector for this test to be performed properly.
- 2) Enter the Test Mode. Refer to Page 135, ENTER THE TEST MODE. The Message Window will briefly display "TestMode" followed by "0 mmHg".
- 3) Press the NIBP START pushbutton to begin the Pressure Check.
- 4) The Message Window will display "Chk Prs", will inflate to approximately 160 mmHg and attempt to hold this pressure. The pressure value will be displayed in the SYSTOLIC display window. This test takes about fifteen (15) seconds.
- 5) At the completion of a successful Pressure Check, the Message Window will display "Passed", the monitor will beep two (2) times and will return to the Calibration Check function after five (5) seconds.
- 6) If the monitor fails the Pressure Check, the Message Window will display "Leak", the monitor will beep three (3) times and the return to the Calibration Check function after five (5) seconds.

Should the monitor fail the 500 ml Pressure Check, it is recommended the monitor be returned to CAS Medical Systems for service.

TEMPERATURE CALIBRATION CHECK

Verify the calibration of the monitor's Temperature circuit, once (1) every year.

To perform a Temperature Calibration Check, obtain a Calibration Key. This key can be purchased directly from Welch Allyn or CAS Medical Systems. Refer to Section 13, ACCESSORIES for part number information.

NOTE:

The Temperature Calibration Check can be performed, at any time, once the monitor enters the Configuration Menu.

- 1) Turn the monitor "OFF".
- 2) Remove the temperature probe and its connector completely from the monitor and insert the Calibration Key.
- 3) Turn the monitor "ON", and enter the monitor's Configuration Menu. Refer to Page 135, ENTER THE TEST MODE.
- 4) Re-insert and remove the temperature probe from the probe guide to reset the thermometer's electronics. An audible "click" should be heard when the SureTemp® probe is completely placed into its holder. The SureTemp Plus® probes will slide in and out of the Probe Well without any restrictions.
- 5) Wait for the test to complete, and observe the display reading in the TEMP display window.
- 6) The display value should read 36.3 +/- 0.1 °C or 97.3 +/-0.1 °F.

NOTE:

The monitor will display the Temperature Calibration Key value using the current temperature units selected.

NOTE:

The Temperature Calibration Key will only operate while the monitor is in the Configuration Menu. If the Calibration Key is inserted during normal monitoring, the TEMP display will show three (3) flashing dashes "- - -" and no value will be displayed.

NOTE:

While in the Configuration Menu, if no pushbutton is pressed within 60 seconds, the monitor will automatically exit the Monitor Configuration menu. The Message Window will briefly display "Saving" and return to the "Ready" mode.

- 7) Remove the Calibration Key and re-insert the temperature probe connector.
- 8) Install the temperature probe into the probe holder. An audible "click" should be heard when the SureTemp® probe is completely placed into its holder. The SureTemp Plus® probes will slide in and out of the Probe Well without any restrictions.

CASMED 740 Monitors

OXIMETRY CALIBRATION CHECK

The oximeter is factory calibrated to determine the percentage of arterial oxygen saturation of functional hemoglobin. No user calibration is required.

REPLACING THE MONITOR BATTERY

A part number for the battery can be found in the Accessories section of this manual or on the label located on the inside panel of the battery pack. When the battery fails to hold a charge it will need to be replaced.

CAS Medical Systems recommends the battery be changed every two (2) years.

REMOVING THE BATTERY

- 1) Turn the monitor "OFF" and disconnect the power cord.
- 2) Push down on the battery latch to unlock the battery door from the rear panel of the monitor.
- 3) Carefully remove the battery pack from the rear panel of the monitor. Refer to Figure 25.

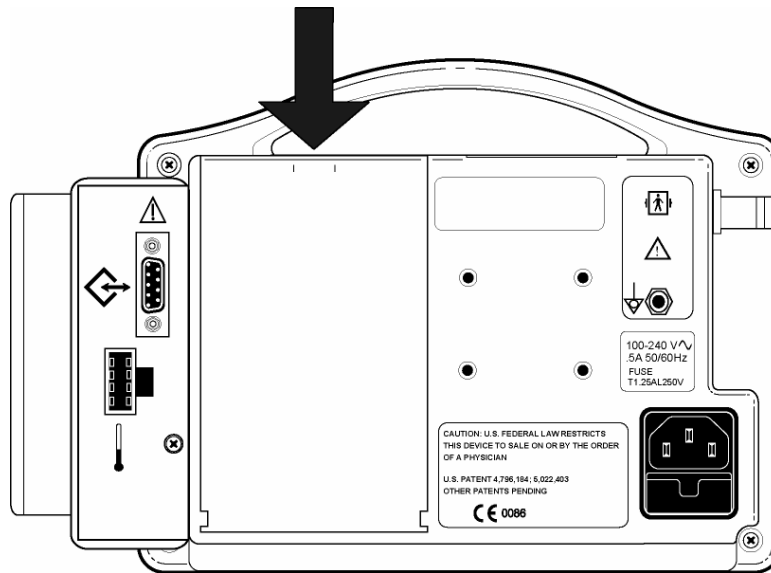

Figure 25: Removing the Monitor Battery Pack

INSTALLING THE BATTERY

- 1) Align the Battery Pack guides with the bottom of the monitor.
- 2) Slowly close the battery door to ensure the connector in the monitor and the connector on the battery pack mate together.
- 3) Lock the battery door closed.

Refer to Page 105, BATTERY POWER for additional battery information.

NOTE:

When the battery pack is re-inserted, the monitor will automatically turn "ON".

WARNING:

Do not disassemble the battery pack or batteries. The batteries contain electrolytes, which can cause injury to eyes, skin and clothing.

NOTE:

This product contains a rechargeable battery that is recyclable. Under various state and local laws, it may be illegal to dispose of this battery into the municipal waste stream. Check with your local authorities for instructions on recycling options in your area.

CHANGING THE FUSES

The CASMED 740 Monitor uses a dual fuse power input receptacle. The receptacle incorporates fuses in the hot and neutral AC input lines that are user serviceable.

CAUTION:

For continued protection against fire hazard, replace only with identically rated fuses. Refer to Section 13, ACCESSORIES for part number information.

A fuse may need to be replaced if the monitor is plugged into an electrical outlet but the Battery Power Visual Indicator is not illuminated the color Green.

WARNING:

Before changing the fuse, unplug the power cord.

The fuse holder is incorporated into the power input receptacle and located under the power cord input connector.

CASMED 740 Monitors

To replace the fuses:

- 1) Turn the monitor "OFF" and disconnect the power cord.
- 2) Press down on the locking tab, which holds the fuse holder in the power input receptacle.
- 3) While holding down on the tab, pull the fuse holder out.
- 4) Remove the fuses.
- 5) Place new fuses directly into the fuse holder.
- 6) Insert the fuse holder into the power input receptacle. There should be an audible "click" when it is secure.

NOTE:

The CASMED 740M (EMS Monitor) uses a single fuse located on the inside of the monitor. This fuse is not user replaceable. If you suspect a defective fuse, (the Battery Power Visual Indicator is not illuminated), it is recommended to contact CAS Medical for service.

STORAGE

WARNING:

If it becomes necessary to store the monitor for longer than six (6) months, remove the monitor's battery pack and place the monitor in its original packing container if available.

WARNING:

Use of unapproved batteries will invalidate the product's warranty and may result in serious safety consequences for the patient and user.

See Section 15, SPECIFICATIONS for storage temperature information.

Section 12

External Device Interfacing

12. EXTERNAL DEVICE INTERFACING

OVERVIEW

The CASMED 740 Monitor is capable of interfacing to an external Serial printer or have the ability to interface to a Nurse Call System if the DB9 RS232 option is available. Both connections are made through the DB9 connector located on the rear panel of the monitor.

WARNING:

The CASMED 740 Monitor has been tested with the Citizen CMP-10 Mobile printer to comply with IEC 60601-1-1 and is the only printer that is recommended to be used with the monitor. If another printer is to be used, the user must read the Warning on Page 40 under LEAKAGE CURRENT TEST and follow the guidance given.

RS232

The CASMED 740 monitor uses the DB9 connector to interface to the Citizen CMP-10 Mobile printer using the cable supplied with the printer. The connector information provided in this section is made available to allow the user the ability to print the monitor's History data to an external serial printer. Refer to Figure 26 and Table 9 for connection information.

Refer to Section 15, SPECIFICATIONS for Serial Interface information.

NURSE CALL INTERFACE

The CASMED 740 Monitor provides an isolated relay switch closure output connection between two (2) of the pins on the DB9 RS232 output connector. The output is compatible with most Nurse Call Systems in that there is no polarity to the connection.

When properly connected, the Nurse Call Interface activates the Nurse Call System each time an alarm is activated on the monitor. The delay time for the Nurse Call Interface to activate is less than 0.5 seconds.

The Nurse Call System's relay contacts are rated at 120 VAC at 0.3A; or 30 VDC at 1.0 A.

The Nurse Call Option is available as a normally open (closed on alarm) or normally closed (open on alarm) depending upon how it is wired.

For normally open (N.O.) applications, the Nurse Call system needs to be connected to pins 1 and 9 of the RS232 connector. For normally closed (N.C.) applications, the Nurse Call system needs to be connected to pins 6 and 9. Refer to Figure 26 and Table 9 for connection information.

WARNING:

The connection to the Nurse Call Interface should only be installed by a qualified service personnel.

CASMED 740 Monitors

WARNING:

The interconnection of auxiliary equipment to the Nurse Call Interface may increase the total leakage current. The user must read the Warning on Page 40 under LEAKAGE CURRENT TEST and follow the guidance given.

NOTE:

Even though the Nurse Call Interface allows remote alarm indication, it does not replace appropriate bedside surveillance by trained clinicians.

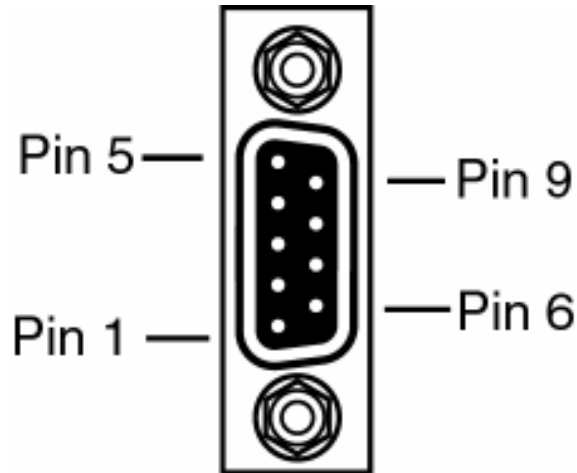

Figure 26: **DB9 Male Connector Pin Layout**

Pin Number	Signal Description
1	Nurse Call (N.O.)
2	Serial Receive In
3	Serial Transmit Out
4	No Connection
5	Isolated Ground
6	Nurse Call (N.C.)
7	No Connection or Isolated +5V (Optional)
8	No Connection
9	Nurse Call (common)

Table 9: **DB9 Pin Out**

Section 13

Accessories

13. ACCESSORIES

Contact our Customer Service Department or see our website for the latest product information. Refer to HOW TO CONTACT US for e-mail and phone number information.

BLOOD PRESSURE CUFFS

Tuff-Cuff®

Reusable Blood Pressure Cuffs (single tube)

Catalog Number	Description	Range
TCS0813ML	Infant	8 – 13 cm
TCS1219ML	Child	12 – 19 cm
TCS1725ML	Small Adult	17 – 25 cm
TCS2333ML	Adult	23 – 33 cm
TCS2333LML	Adult Long	23 – 33 cm
TCS31040ML	Large Adult	31 – 40 cm
TCS3140LML	Large Adult Long	31 – 40 cm
TCS3850ML	Adult Thigh	38 – 50 cm

UltraCheck®

Reusable Blood Pressure Cuffs (single tube)

Catalog Number	Description	Range
US0814ML	Infant	8 – 14 cm
US1320ML	Child	13 – 20 cm
US1826ML	Small Adult	18 – 26 cm
US2635ML	Adult	26 – 35 cm
US2938ML	Adult Long	29 – 38 cm
US3242ML	Large Adult	32 – 42 cm
US3544ML	Large Adult Long	35 – 44 cm
US4250ML	Adult Thigh	42 – 50 cm

CASMED 740 Monitors

Safe-Cuff™

Single Patient Use Blood Pressure Cuffs (single tube)

Catalog Number	Description	Range
VNN1ST	Neonate – 1	3 – 6 cm
VNN2ST	Neonate – 2	4 – 8 cm
VNN3ST	Neonate – 3	6 – 11 cm
VNN4ST	Neonate – 4	7 – 14 cm
VNN5ST	Neonate – 5	8 – 15 cm
VST0814ML	Infant	8 – 14 cm
VST1320ML	Child	13 – 20 cm
VST1826ML	Small Adult	18 – 26 cm
VST2635ML	Adult	26 – 35 cm
VST2938ML	Adult Long	29 – 38 cm
VST3242ML	Large Adult	32 – 42 cm
VST3544ML	Large Adult Long	35 – 44 cm
VST4250ML	Adult Thigh	42 – 50 cm

INFLATION HOSES

Catalog No.	Description
01-01-0495	Ten (10) FT Coiled NIBP Hose, Adult and Pediatric, Bayonet
01-02-0185	Six (6) FT Straight NIBP Hose, Neonatal and Infant
01-02-0131	Ten (10) FT Coiled NIBP Hose, Adult and Pediatric

OXIMETRY

Masimo

Note: Use only with Masimo Pulse Oximeter

Catalog No.	Description	
01-02-0178	LNOP DCI	Adult Reusable Finger Clip Sensor
01-02-0190	LNOP DCIP	Pediatric Sensor
01-02-0191	LNOP YI	Multisite Sensor
01-02-0312	DC-195	Adult Reusable Finger Clip Sensor
01-02-0432	LNOP TC-1	Reusable Ear Sensor
01-02-0251	LNOP ADT	Adult Single Patient Adhesive Sensor (box of 20)
01-02-0252	LNOP ADT LNG	Adult Single Patient Adhesive Sensor, Long Cbl (box of 20)
01-02-0253	LNOP PDT	Pediatric/Slender Digit Single Patient Adhesive Sensor (box of 20)
01-02-0254	LNOP NEO	Neonatal Single Patient Adhesive Sensor (box of 20)
01-02-0255	LNOP NEOPT	Neonatal Preterm Single Patient Adhesive Sensor (box of 20)
01-02-0182	PC04	Patient Cable, 4 FT
01-02-0192	PC08	Patient Cable, 8 FT

Nellcor

Note: Use only with Nellcor Pulse Oximeter

Catalog No.	Description	
01-02-0179	DS-100A	Adult Reusable Finger Clip Sensor
01-02-0183	DOC-10	OxiMax Patient Cable, 10 FT

Nonin

Note: Use only with Nonin Pulse Oximeter

Catalog No.	Description	
01-02-0100	8500I	SpO ₂ Extension Cable, 1 Meter
01-02-0106	8000AP-3	Pediatric Finger Clip Sensor, 9 ft / 3 Meter Cable
01-02-0108	8000Q	Ear Clip Sensor
01-02-0244	8000JFW	Sensor Attachment Tape, 25/case
01-02-0136	8500VI	SpO ₂ Extension Cable, 3 Meter
01-02-0250	8000AA-2	Adult Articulated Finger Clip Sensor, 6 ft/ 2 Meter Cable
01-03-0117	8000AA-3	Adult Articulated Finger Clip Sensor, 9 ft/ 3 Meter Cable
01-03-0120	8000AA-1	Adult Articulated Finger Clip Sensor, 3 ft/ 1 Meter Cable
01-03-0121	8000AP	Pediatric Finger Clip Sensor, 3 ft / 1 Meter Cable
01-03-0122	8000K2	Adult Finger Clip Sensor, 3 ft / 1 Meter Cable
01-03-0123	8000R	Reflectance Sensor
01-03-0124	8000J	Adult Flex Sensor (Straight)
01-03-0125	8000H	Reflectance Sensor Holder System
01-03-0126	8000T	Sensor Attachment Tape
01-03-0127	8000TH	Hydro-gel Tape Strips

CASMED 740 Monitors

TEMPERATURE

Welch Allyn

Catalog No.	Description	
01-02-0095	06137-000	SureTemp® Calibration Key
01-02-0096	02678-100	Temperature Probe, Oral
01-02-0097	02679-100	Temperature Probe, Rectal
01-02-0455	06138-000	SureTemp Plus® Calibration Key
01-02-0457	02895-000	SureTemp Plus® Probe, Oral and probe well
01-02-0456	02895-100	SureTemp Plus® Probe, Rectal and probe well
01-02-0103	05031	Temperature Probe Covers, case of 40 boxes (25 Probe covers/box)

OTHER ACCESSORIES

Catalog No.	Description
01-01-0047	P9 Calibration Kit (includes T - connector with tubing and male luer plug)
01-02-0172G	Roll Stand with Basket (US Government customers only)
01-02-0173	Swivel Mount Kit
01-02-0174	Carry Bag
01-02-0176	RS232 Interface
01-02-0181G	Printer Bracket Attachment for Roll Stand
01-02-0189	Printer, includes Battery, RS232 Cable, Power Supply, One (1) Roll of Paper and Manual
01-02-0243	Universal Mount
01-02-0248	500 ml Fixed Volume Cylinder
01-02-0297	Roll Stand with Quick Release, Steelcraft
01-02-0301	Printer Bracket, used with Steelcraft Roll Stand
01-04-0016	U.S.A. Replacement Power Cord
01-05-0144	International Power Cord IEC320 European Plug
03-08-0386	DC Power Cable
03-08-0450	Monitor Battery Pack (7.2 VDC, 3700 mAh)
09-01-0002	Fuse (250V, 500mA, 5 x 20mm, Slow Blow), 2 per monitor. Refer to the monitor's rear panel labeling for actual fuse rating.
09-01-0034	Fuse (250V, 1.25A, 5 x 20mm, Slow Blow), 2 per monitor. Refer to the monitor's rear panel labeling for actual fuse rating.
18-04-0004	Australian Power Cord
18-04-0010	U.K. Power Cord
21-02-0171	CASMED 740 User's Manual, English
21-02-0173	CASMED 740 User's Manual, Spanish
21-02-0175	CASMED 740 User's Manual, German
21-02-0176	CASMED 740 User's Manual, French
21-02-0177	CASMED 740 User's Manual, Italian
21-02-0178	CASMED 740 User's Manual, Dutch
21-02-0179	CASMED 740 User's Manual, Portuguese
21-02-0180	CASMED 740 User's Manual, Swedish
21-02-0174	CASMED 740 Service Manual
28-02-0077	Printer Paper, One (1) Roll

MONITOR CONFIGURATIONS

Model	Description
CASMED 740-1	MAXNIBP®, 100-240V, 50/60HZ, AC Power Supply and Battery
CASMED 740M-1	MAXNIBP®, 12VDC Power input with Battery, Mount included
CASMED 740-2MS	MAXNIBP® and Masimo SpO ₂ , 100-240V, 50/60HZ, AC Power Supply and Battery
CASMED 740M-2MS	MAXNIBP® and Masimo SpO ₂ , 12VDC Power input with Battery, Mount included
CASMED 740-2NL	MAXNIBP® and Nellcor SpO ₂ , 100-240V, 50/60HZ, AC Power Supply and Battery
CASMED 740M-2NL	MAXNIBP® and Nellcor SpO ₂ , 12VDC Power input with Battery, Mount included
CASMED 740-2NN	MAXNIBP® and Nonin SpO ₂ , 100-240V, 50/60HZ, AC Power Supply and Battery
CASMED 740M-2NN	MAXNIBP® and Nonin SpO ₂ , 12VDC Power input with Battery, Mount included
CASMED 740-2T	MAXNIBP® and Temperature, 100-240V, 50/60HZ, AC Power Supply and Battery
CASMED 740M-2T	MAXNIBP® and Temperature, 12VDC Power input with Battery, Mount included
CASMED 740-3MS	MAXNIBP®, Masimo SpO ₂ , and Temperature, 100-240V, 50/60HZ, AC Power Supply and Battery
CASMED 740M-3MS	MAXNIBP®, Masimo SpO ₂ , and Temperature, 12VDC Power input with Battery, Mount included
CASMED 740-3NL	MAXNIBP®, Nellcor SpO ₂ , and Temperature, 100-240V, 50/60HZ, AC Power Supply and Battery
CASMED 740M-3NL	MAXNIBP®, Nellcor SpO ₂ , and Temperature, 12VDC Power input with Battery, Mount included
CASMED 740-3NN	MAXNIBP®, Nonin SpO ₂ , and Temperature, 100-240V, 50/60HZ, AC Power Supply and Battery
CASMED 740M-3NN	MAXNIBP®, Nonin SpO ₂ , and Temperature, 12VDC Power input with Battery, Mount included

Table 10: Monitor Configurations

This page is intentionally left blank

Section 14

Glossary

14. GLOSSARY

Diastolic

The Diastolic pressure is the bottom (lower) number given in a blood pressure reading. This number represents the amount of pressure present in the system between heartbeats.

Mean Arterial Pressure (MAP)

The MAP pressure represents the mean pressure in the artery during one cardiac cycle.

NIBP

Non-Invasive Blood Pressure. Abbreviation used when a blood pressure reading is taken externally using a non-invasive procedure.

SpO₂ (%SpO₂)

Abbreviation used when oxygen saturation level of the blood is measured with a pulse oximeter.

Systolic

The Systolic pressure is the upper (top) number given in a blood pressure reading. This number represents the maximum pressure present in the artery.

This page is intentionally left blank

Section 15

Specifications

15. SPECIFICATIONS

NIBP MEASUREMENT

Characteristic	Specification	
Technique:	Oscillometric (MAX NIBP® Technology) Microprocessor software eliminates most ambient noise and motion artifact.	
Patient Range:	Neonate – Adult	
Blood Pressure Range	NEO	ADULT
	Systolic:	30 – 135 mmHg 30 – 255 mmHg
	Diastolic:	15 – 110 mmHg 15 – 220 mmHg
	MAP:	20 – 125 mmHg 20 – 235 mmHg
Pulse Rate Range:	40 – 240 BPM	30 – 240 BPM
Accuracy		
Blood Pressure:	+/-5 mmHg with a standard deviation no greater than 8 mmHg (See Standards)	
Pulse Rate:	+/-2% or +/-2 BPM, whichever is greater	

OXIMETRY (OPTIONS)

Characteristic	Specification	
Nonin®		
Type:	Functional Oxygen Saturation	
SpO ₂ % Range:	0 - 100%	
SpO ₂ Accuracy:	<u>Sensor</u> 8000AA 8000AP 8000K2	<u>Accuracy</u> 70 - 100%, +/-2 digits (1 S.D.)
	<u>Sensor</u> 8000J 8000R	<u>Accuracy</u> 70 - 100%, +/-3 digits (1 S.D.)
	<u>Sensor</u> 8000Q	<u>Accuracy</u> 70 - 100%, +/-4 digits (1 S.D.)
Measurement Wavelengths:	Red 660 nanometers	
	Infrared 910 Nanometers	
Power:	3 mW nominal	
Pulse Rate Range:	18 - 240 BPM	
Pulse Rate Accuracy:	+/-3% or +/-1 digit, whichever is greater	
Numerics:	Updated every one (1) second.	

NOTE:

For further information on sensors and sensor accuracy, contact Nonin.

CASMED 740 Monitors

Characteristic	Specification																				
Masimo SET®																					
Type:	Functional Oxygen Saturation																				
SpO ₂ % Range:	0 - 100%																				
SpO ₂ Accuracy:	<table border="0"> <thead> <tr> <th><u>Sensor</u></th> <th><u>Accuracy</u></th> </tr> </thead> <tbody> <tr> <td>DC-195</td> <td>70 - 100%, +/-2 digits (1 S.D.)</td> </tr> <tr> <td>LNOP® Adt</td> <td></td> </tr> <tr> <td>LNOP DCI</td> <td></td> </tr> <tr> <td>LNOP DCSC</td> <td></td> </tr> <tr> <td>LNOP DC1P</td> <td></td> </tr> <tr> <td>LNOP DC150</td> <td></td> </tr> <tr> <td>LNOP Pdt</td> <td></td> </tr> <tr> <td>LNOP Y-1</td> <td></td> </tr> <tr> <td>LNOPv Ad</td> <td></td> </tr> </tbody> </table>	<u>Sensor</u>	<u>Accuracy</u>	DC-195	70 - 100%, +/-2 digits (1 S.D.)	LNOP® Adt		LNOP DCI		LNOP DCSC		LNOP DC1P		LNOP DC150		LNOP Pdt		LNOP Y-1		LNOPv Ad	
<u>Sensor</u>	<u>Accuracy</u>																				
DC-195	70 - 100%, +/-2 digits (1 S.D.)																				
LNOP® Adt																					
LNOP DCI																					
LNOP DCSC																					
LNOP DC1P																					
LNOP DC150																					
LNOP Pdt																					
LNOP Y-1																					
LNOPv Ad																					
	<table border="0"> <thead> <tr> <th><u>Sensor</u></th> <th><u>Accuracy</u></th> </tr> </thead> <tbody> <tr> <td>LNOP Neo</td> <td>70 - 100%, +/-3 digits (1 S.D.)</td> </tr> <tr> <td>LNOP Neo Pt</td> <td></td> </tr> </tbody> </table>	<u>Sensor</u>	<u>Accuracy</u>	LNOP Neo	70 - 100%, +/-3 digits (1 S.D.)	LNOP Neo Pt															
<u>Sensor</u>	<u>Accuracy</u>																				
LNOP Neo	70 - 100%, +/-3 digits (1 S.D.)																				
LNOP Neo Pt																					
	<table border="0"> <thead> <tr> <th><u>Sensor</u></th> <th><u>Accuracy</u></th> </tr> </thead> <tbody> <tr> <td>LNOP EAR</td> <td>70 - 100%, +/-3.5 digits (1 S.D.)</td> </tr> </tbody> </table>	<u>Sensor</u>	<u>Accuracy</u>	LNOP EAR	70 - 100%, +/-3.5 digits (1 S.D.)																
<u>Sensor</u>	<u>Accuracy</u>																				
LNOP EAR	70 - 100%, +/-3.5 digits (1 S.D.)																				
Measurement Wavelengths:	Red 660 Nanometers																				
	Infrared 905 Nanometers																				
Power:	Maximum radiant power at 50 mA pulsed is 0.79mW																				
Pulse Rate Range:	25 - 240 BPM																				
Pulse Rate Accuracy:	+/-3 BPM																				
Numerics:	Updated every one (1) second.																				

NOTE:

For further information on sensors and sensor accuracy, contact Masimo.

Characteristic	Specification																
Nellcor® OxiMax®																	
Type:	Functional Oxygen Saturation																
SpO ₂ % Range:	1 - 100%																
SpO ₂ Accuracy:	<table style="width: 100%; border-collapse: collapse;"> <thead> <tr> <th style="text-align: left; border-bottom: 1px solid black;"><u>Sensor</u></th> <th style="text-align: left; border-bottom: 1px solid black;"><u>Accuracy</u></th> </tr> </thead> <tbody> <tr> <td>MAX-A</td> <td>70 - 100%, +/-2 digits (1 S.D.)</td> </tr> <tr> <td>MAX-AL</td> <td></td> </tr> <tr> <td>MAX-N (Adult)</td> <td></td> </tr> <tr> <td>MAX-P</td> <td></td> </tr> <tr> <td>MAX-I</td> <td></td> </tr> <tr> <td>MAX-FAST</td> <td></td> </tr> <tr> <td>SC-A (Adult)</td> <td></td> </tr> </tbody> </table>	<u>Sensor</u>	<u>Accuracy</u>	MAX-A	70 - 100%, +/-2 digits (1 S.D.)	MAX-AL		MAX-N (Adult)		MAX-P		MAX-I		MAX-FAST		SC-A (Adult)	
<u>Sensor</u>	<u>Accuracy</u>																
MAX-A	70 - 100%, +/-2 digits (1 S.D.)																
MAX-AL																	
MAX-N (Adult)																	
MAX-P																	
MAX-I																	
MAX-FAST																	
SC-A (Adult)																	
	<table style="width: 100%; border-collapse: collapse;"> <thead> <tr> <th style="text-align: left; border-bottom: 1px solid black;"><u>Sensor</u></th> <th style="text-align: left; border-bottom: 1px solid black;"><u>Accuracy</u></th> </tr> </thead> <tbody> <tr> <td>OxiCliq A</td> <td>70 - 100%, +/-2.5 digits (1 S.D.)</td> </tr> <tr> <td>OxiCliq I</td> <td></td> </tr> <tr> <td>OxiCliq N (Adult)</td> <td></td> </tr> <tr> <td>OxiCliq P</td> <td></td> </tr> </tbody> </table>	<u>Sensor</u>	<u>Accuracy</u>	OxiCliq A	70 - 100%, +/-2.5 digits (1 S.D.)	OxiCliq I		OxiCliq N (Adult)		OxiCliq P							
<u>Sensor</u>	<u>Accuracy</u>																
OxiCliq A	70 - 100%, +/-2.5 digits (1 S.D.)																
OxiCliq I																	
OxiCliq N (Adult)																	
OxiCliq P																	
	<table style="width: 100%; border-collapse: collapse;"> <thead> <tr> <th style="text-align: left; border-bottom: 1px solid black;"><u>Sensor</u></th> <th style="text-align: left; border-bottom: 1px solid black;"><u>Accuracy</u></th> </tr> </thead> <tbody> <tr> <td>DS-100A</td> <td>70 - 100%, +/-3 digits (1 S.D.)</td> </tr> <tr> <td>D-YS (Infant to Adult)</td> <td></td> </tr> <tr> <td>MAX-N (Neonate)</td> <td></td> </tr> <tr> <td>OXI-A/N (Adult)</td> <td></td> </tr> <tr> <td>OXI-P/I</td> <td></td> </tr> <tr> <td>SC-NEO (Neonate)</td> <td></td> </tr> <tr> <td>SC-PR (Neonate)</td> <td></td> </tr> </tbody> </table>	<u>Sensor</u>	<u>Accuracy</u>	DS-100A	70 - 100%, +/-3 digits (1 S.D.)	D-YS (Infant to Adult)		MAX-N (Neonate)		OXI-A/N (Adult)		OXI-P/I		SC-NEO (Neonate)		SC-PR (Neonate)	
<u>Sensor</u>	<u>Accuracy</u>																
DS-100A	70 - 100%, +/-3 digits (1 S.D.)																
D-YS (Infant to Adult)																	
MAX-N (Neonate)																	
OXI-A/N (Adult)																	
OXI-P/I																	
SC-NEO (Neonate)																	
SC-PR (Neonate)																	
	<table style="width: 100%; border-collapse: collapse;"> <thead> <tr> <th style="text-align: left; border-bottom: 1px solid black;"><u>Sensor</u></th> <th style="text-align: left; border-bottom: 1px solid black;"><u>Accuracy</u></th> </tr> </thead> <tbody> <tr> <td>D-YS</td> <td>70 - 100%, +/-3.5 digits (1 S.D.)</td> </tr> <tr> <td>D-YSE</td> <td></td> </tr> <tr> <td>D-YSPD</td> <td></td> </tr> <tr> <td>OxiCliq N (Neonate)</td> <td></td> </tr> </tbody> </table>	<u>Sensor</u>	<u>Accuracy</u>	D-YS	70 - 100%, +/-3.5 digits (1 S.D.)	D-YSE		D-YSPD		OxiCliq N (Neonate)							
<u>Sensor</u>	<u>Accuracy</u>																
D-YS	70 - 100%, +/-3.5 digits (1 S.D.)																
D-YSE																	
D-YSPD																	
OxiCliq N (Neonate)																	
	<table style="width: 100%; border-collapse: collapse;"> <thead> <tr> <th style="text-align: left; border-bottom: 1px solid black;"><u>Sensor</u></th> <th style="text-align: left; border-bottom: 1px solid black;"><u>Accuracy</u></th> </tr> </thead> <tbody> <tr> <td>MAX-R</td> <td>80 - 100%, +/-3.5 digits (1 S.D.)</td> </tr> </tbody> </table>	<u>Sensor</u>	<u>Accuracy</u>	MAX-R	80 - 100%, +/-3.5 digits (1 S.D.)												
<u>Sensor</u>	<u>Accuracy</u>																
MAX-R	80 - 100%, +/-3.5 digits (1 S.D.)																
	<table style="width: 100%; border-collapse: collapse;"> <thead> <tr> <th style="text-align: left; border-bottom: 1px solid black;"><u>Sensor</u></th> <th style="text-align: left; border-bottom: 1px solid black;"><u>Accuracy</u></th> </tr> </thead> <tbody> <tr> <td>D-YS (Neonate)</td> <td>70 - 100%, +/-4.0 digits (1 S.D.)</td> </tr> <tr> <td>OXI-A/N (Neonate)</td> <td></td> </tr> </tbody> </table>	<u>Sensor</u>	<u>Accuracy</u>	D-YS (Neonate)	70 - 100%, +/-4.0 digits (1 S.D.)	OXI-A/N (Neonate)											
<u>Sensor</u>	<u>Accuracy</u>																
D-YS (Neonate)	70 - 100%, +/-4.0 digits (1 S.D.)																
OXI-A/N (Neonate)																	
Measurement Wavelengths:	Red 660 Nanometers Infrared 890 Nanometers																
Power:	Not exceeding 15 mW																
Pulse Rate Range:	20 - 240 BPM																
Pulse Rate Accuracy:	+/-3 digits																
Numerics:	Updated every one (1) second.																

NOTE:
For further information on sensors and sensor accuracy, contact Nellcor.

CASMED 740 Monitors

TEMPERATURE (OPTIONAL)

Characteristic	Specification
Temperature Range:	28.9 to 42.2 °C (84.0 to 108.0 °F)
Accuracy:	+/-0.1 °C (+/-0.2 °F), Meets or exceeds ASTM Standards

PATIENT ALARMS

CASMED 740
with NIBP

Patient Parameter	Neonatal Limit Range		Adult Limit Range	
	Low	High	Low	High
SYS	35 – 130	35 – 130	35 – 250	35 – 250
DIA	20 – 105	20 – 105	20 – 215	20 – 215
MAP	25 – 120	25 – 120	25 – 230	25 – 230
Pulse	45 – 235	45 – 235	35 – 235	35 – 235

CASMED 740
with NIBP and
SpO₂

Patient Parameter	Neonatal Limit Range		Adult Limit Range	
	Low	High	Low	High
SYS	35 – 130	35 – 130	35 – 250	35 – 250
DIA	20 – 105	20 – 105	20 – 215	20 – 215
MAP	25 – 120	25 – 120	25 – 230	25 – 230
%SpO ₂	70 – 95	80 – 99	70 – 95	80 – 99
Pulse	25 – 235	25 – 235	25 – 235	25 – 235

NOTE:

Each alarm limit may also be selected "OFF" individually or as a whole.
Low Limits cannot be set above the associated High Limit.
High Limits cannot be set lower than the associated Low Limit.

CONTROL PANEL

Characteristic	Specification
Display:	LED display of measurement results, instructions, troubleshooting messages and signal strength bar.
Parameters Displayed:	Systolic Pressure, Diastolic Pressure and Mean Arterial Pressure (MAP) Pulse Rate %SpO ₂ Temperature (in Fahrenheit or Celsius)

SAFETY LIMITS

Characteristic	Specification
Automatic Cuff Deflation:	If cuff pressure exceeds 290 mmHg (Adult); 145 mmHg (Neonate) If measurement time exceeds 120 seconds (Adult), 90 seconds (Neonate) If safety timer detects microprocessor failure

OPERATING MODES

Characteristic	Specification
Patient:	NIBP function in Neonatal or Adult
NIBP:	Manual, STAT or Automatic (at preset intervals)
History:	Review of previous measurements
%SpO ₂ :	Continuous Monitoring
Temperature:	Predictive or Continuous Monitoring

POWER

Characteristic	Specification
Source:	External line or internal battery
AC Power:	100 - 240 VAC, 50/60 Hz, 0.5A; Fuse Rating – T500mAL250V or T1.25AL250V (two provided). Refer to rear panel monitor labeling for actual fuse rating.
DC Power (EMS Option):	+12 VDC; 7W; Fuse Rating – Wickman Type TE5, Time Lag, 3.15A, 125VAC or approved equivalent (one provided)
Battery:	Nickel Metal Hydride (NiMH) battery pack (user removable) Charge Time: 4 hours Operation on battery: 100 NIBP readings when set in the 5-minute Automatic Mode
Leakage Current:	100 microamp (maximum)

FEATURES

Characteristic	Specification
Self Test:	System self test is performed each time power is turned on.
Auto Zero:	Zero pressure reference is automatically established after every reading.
Inflation:	Initial inflation to 150 mmHg (Adult) or 85 mmHg (Neonatal) or user selectable. (80, 100, 120, 140, 150, 160, 180, 200) - Adult ; (60, 80, 85, 100, 120) - Neonatal. Subsequent inflation to approximately 30 mmHg greater than previous Systolic pressure.
Deflation:	Automatic
Max Measurement Time:	Limited to 120 seconds (Adult), 90 seconds (Neonate)

CASMED 740 Monitors

OPERATING ENVIRONMENT

Characteristic	Specification
Operating Temperature:	0 °C to 50 °C (32 °F to 122 °F)
Humidity:	15 to 95%, non-condensing
Altitude:	10,000 to -1,250 ft (700 – 1050 hPa)

Monitors may not meet performance specifications if stored or used outside temperature and humidity ranges. When moving the monitor from a storage location, wait at least one-hour prior to use to allow the monitor to adjust to room temperature.

STORAGE/TRANSPORT ENVIRONMENT

Characteristic	Specification
Storage / Transport Temperature:	-20 °C to 60 °C (-4 °F to 140 °F)
Humidity:	15 to 95%, non-condensing
Altitude:	10,000 to -1,250 ft (700 – 1050 hPa)

PHYSICAL DIMENSIONS & WEIGHT

Characteristic	Specification
Base Unit	
H x W x D:	6.75 in x 8.5 in x 3.0 in (17 cm x 21.5 cm x 7.5 cm)
Weight:	3 lbs approx. (1.4 kg)

SERIAL INTERFACE

Characteristic	Specification
Interface:	Bi-directional serial communication
Speed:	9600 – Printer 115200 – CAS Serial Protocol
Signal Level:	RS232C
Data Length:	8 bits
Start Bit:	1 bit
Stop Bit:	1 bit
Parity:	None
Flow Control:	None

OPTIONAL ACCESSORIES

Infrared Printer
Swiveled Hard Mount (for ambulance applications)
Roll Stand and Basket
Protective Carrying case

CASMED 740 Monitors

STANDARDS

Accuracy complies with that given in American National Standard for Electronic or Automated Sphygmomanometers, ANSI/AAMI SP10, 2002. Adult blood pressure measurements determined with this device are equivalent to those obtained by an auscultatory blood pressure measurement device and neonatal ones are equivalent to those obtained by an intra-arterial blood pressure device, within the limits prescribed by the American National Standard for Electronic or Automated Sphygmomanometers. The 4th Korotkoff sound was used to determine Diastolic pressure. Study findings are available.

Units comply with the following requirements:

- IEC 60601-1
- EN 60601-1-2
- IEC 865
- IEC 60601-2-30
- IEC 60601-2-49
- ETL Listed - UL 2601, CAN/CSA C22.2 No.601.1
- CE marking according to Directive 93/42/EEC

MAXNIBP[®], Tuff-Cuff[®], SoftCheck[®], and UltraCheck[®] are registered trademarks of CAS Medical Systems, Inc.

Safe-Cuff[™] and CASMED[™] are trademarks of CAS Medical Systems, Inc.

Masimo SET[®] is a registered trademark of Masimo, Inc.

Possession or purchase of this device does not convey any express or implied license to use the device with replacement parts which would, alone, or in combination with this device, fall within the scope of one or more of the patents relating to this device.

Nellcor[®] and OxiMax[®] are registered trademarks of Nellcor Puritan Bennett, Inc.

NONIN[®], NONIN[®] Finger Clip Sensor and Flexi-Form Sensors are registered trademarks of Nonin Medical, Inc.

SureTemp[®] and SureTemp Plus[®] are registered trademarks of Welch Allyn, Inc.

All units covered by U.S. patent 4,796,184 and 5,022,403. Other patents pending.

Monitors are  marked.

16. PURCHASING RECORD

CASMED 740 VITAL SIGNS MONITOR

Installed Options:

NIBP () SpO₂ () Temperature ()

RS232 ()

Model: _____

Serial Number: _____

Date of Purchase: _____

Dealer Name: _____

Representative: _____

Phone Number: _____

Fax Number: _____

Email: _____