

LEGACY

OPERATOR'S MANUAL

CADD-Legacy™ 1

Ambulatory Infusion Pump
Model 6400

CONTINUOUS DELIVERY

*This online version differs
from the printed version.*

*Certain information that
is not intended for patients
has been removed.*

This Operator's Manual is for clinician use only.
Read the entire Operator's Manual before
operating the pump.

SIMS DELTEC, INC.

This manual pertains **only** to the Deltec CADD-Legacy™ 1 Model 6400 ambulatory infusion pump. This pump delivers medication at a continuous rate in milliliters (ml) per 24 hours. This manual is intended for clinician use only. Do not permit patients to have access to this manual. The pump has three security levels designed to limit patient access. Do not disclose the pump's security codes or any other information that would allow inappropriate access to programming and operating functions.

The issue date of this Operator's Manual is included on the back cover for the clinician's information. In the event one year has elapsed between the issue date and product use, the clinician should contact SIMS Deltec, Inc. to see if a later revision of this manual is available.

Technical Assistance

If you have comments or questions concerning the operation of the CADD-Legacy™ pump, please call the appropriate number given below. When calling, please specify your pump's software module. This information is located on the start-up screen.

Our staff at Deltec is available to help clinicians twenty-four hours a day with the programming and operation of the CADD-Legacy™ infusion system.

U.S. Distribution

SIMS Deltec, Inc.
1265 Grey Fox Road
St. Paul, Minnesota 55112 U.S.A.
1-800-426-2448

European Representative

SIMS Graseby Ltd.
WD2 4LG UK
+44 (0) 1923 246434

CADD, Medication Cassette Reservoir design, CADD-Legacy, and Medication Cassette are SIMS trademarks. (The symbol ® indicates it is registered in the U.S. Patent and Trademark Office and certain other countries.)

DURACELL® is a registered trademark of Duracell Inc. EVEREADY® ENERGIZER® is a registered trademark of Union Carbide Corp. Super Sani-Cloth® is a registered trademark of Professional Disposables, Inc.

The products described are covered by one or more of the following: U. S. Patent Nos. 4,559,038; 4,565,542; 4,650,469; 5,364,242; 5,531,697; 5,538,399; 5,540,561; 5,564,915; 5,567,119; 5,567,136; 5,647,854; 5,695,473; Japanese Patent No. 2034590; European Patent No. 0182502; other patent(s) pending, foreign patent(s) pending.

Read this entire Operator's Manual before operating the CADD-Legacy™ ambulatory infusion pump.

Failure to properly follow warnings, cautions, and instructions could result in death or serious injury to the patient.

Warnings

- This Operator's Manual should be used by clinicians only. Do not permit patients to have access to this manual, as the information contained would allow the patient complete access to all programming and operating functions. Improper programming could result in death or serious injury to the patient.
- For those patients who are likely to be adversely affected by unintended operations and failures, including interrupted medication or fluid delivery from the device, close supervision and provision for immediate corrective action should be provided.
- If the pump is used to deliver life-sustaining medication, an additional pump must be available.
- The pump is not to be used for delivery of blood or cellular blood products.
- If the pump is dropped or hit, inspect the pump for damage. Do not use a pump that is damaged or is not functioning properly. Contact Customer Service to return a pump for service.
- Use of a syringe with the CADD® Administration Set may result in UNDER-DELIVERY of medication. Syringe function can be adversely affected by variations in plunger dimension and lubricity, which can result in greater force required to move the syringe plunger. A syringe plunger will lose lubrication as it ages and, as a result, the amount of under-delivery will increase which could on occasion, be significant. Therefore, the type of medication and delivery accuracy required must be considered when using a syringe with the CADD® pump.

Clinicians must regularly compare the volume remaining in the

-
- syringe to the pump's displayed values such as RES VOL and GIVEN in order to determine whether under-delivery of medication is occurring and if necessary, take appropriate action.
- System delivery inaccuracies may occur as a result of back pressure or fluid resistance, which depends upon drug viscosity, catheter size, and extension set tubing (for example, microbore tubing).
 - Do not administer drugs to the epidural space or subarachnoid space unless the drug is indicated for administration to those spaces.
 - To prevent infusion of drugs that are not indicated for epidural space or subarachnoid space infusion, do not use administration sets that incorporate injection sites.
 - If a Medication Cassette™ Reservoir, CADD® Extension Set or CADD® Administration Set is used for drug delivery into the epidural or subarachnoid space, clearly differentiate them from those used for other routes of infusion, for example, by color coding, or other means of identification.
 - When the Air Detector is turned off, the pump will not detect air in the fluid path. Periodically inspect the fluid path and remove any air to prevent air embolism.
 - You must use a CADD® Extension Set with an Anti-Siphon Valve or a CADD® Administration Set with either an integral or Add On Anti-Siphon Valve to protect against unregulated gravity infusion that can result from an improperly attached cassette.
 - When the Upstream Occlusion Sensor is turned off, the pump will not detect occlusions upstream (between pump and fluid container). Periodically inspect the fluid container for decreasing volume, inspect the fluid path for kinks, a closed clamp, or other upstream obstructions. Upstream occlusions could result in under- or non-delivery of medications.
 - Do not disclose to the patient the pump's security codes or any

other information that would allow the patient complete access to all programming and operating functions.

- Do not use rechargeable NiCad or nickel metal hydride (NiMH) batteries. Do not use carbon zinc (“heavy duty”) batteries. They do not provide sufficient power for the pump to operate properly.
- Always have new batteries available for replacement. If power is lost, non-delivery of drug will occur.
- If the pump is dropped or hit, the battery door tabs may break. Do not use the pump if the battery door or tabs are damaged because the batteries will not be properly secured; this may result in loss of power and non-delivery of drug.
- If a gap is present anywhere between the battery door and the pump housing, the door is not properly latched. If the battery door becomes detached or loose, the batteries will not be properly secured; this could result in loss of power and nondelivery of drug.
- Close the fluid path tubing with the clamp before removing the cassette from the pump to prevent unregulated gravity infusion.
- For detailed instructions and warnings pertaining to Medication Cassette™ Reservoir or CADD® Administration Sets, please refer to the instructions supplied with those products.
- Frozen medication must be thawed at room temperature only. Do not heat the Medication Cassette™ Reservoir in a microwave oven as this may damage the medication, the Medication Cassette™ Reservoir, or cause leakage.
- Attach the cassette (the part of the Medication Cassette™ Reservoir or CADD® Administration Set that attaches to the pump) properly. An improperly attached or detached cassette could result in unregulated gravity infusion of medication from the fluid container or a reflux of blood.

-
- Do not prime the fluid path with the tubing connected to a patient as this could result in overdelivery of medication or air embolism.
 - Ensure that the entire fluid path is free of all air bubbles before connecting to the patient to prevent air embolism.
 - Prior to starting infusion, inspect the fluid path for kinks, a closed clamp, or other upstream obstructions, and remove any air to prevent air embolism.

Cautions

- Do not operate the pump at temperatures below +2°C (36°F) or above 40°C (104°F).
- Do not store the pump at temperatures below -20°C (-4°F) or above 60°C (140°F). Do not store the pump with the Medication Cassette™ Reservoir or CADD® Administration Set attached. Use the Protective Cassette provided.
- Do not expose the pump to humidity levels below 20% or above 90% relative humidity.
- Do not store the pump for prolonged periods with the batteries installed.
- Do not immerse the pump in cleaning fluid or water or allow solution to soak into the pump, accumulate on the keypad, or enter the battery compartment.
- Do not clean the pump with acetone, other plastic solvents, or abrasive cleaners.
- Do not expose the pump to therapeutic levels of ionizing radiation.
- Do not expose the pump directly to ultrasound.
- Do not use the pump in the vicinity of magnetic resonance imaging (MRI) equipment.

-
- Do not use the pump near ECG equipment.
 - Do not sterilize the pump.
 - Do not use the pump in the presence of flammable anesthetics or explosive gases.
 - Use only Deltec accessories as using other brands may adversely affect the operation of the pump.
 - CADD-Legacy™ pumps are sealed units. A broken or damaged seal will, therefore, be considered conclusive evidence that the pump has been misused and/or altered, which voids any and all warranties. All service and repair of CADD-Legacy™ pumps must be performed by Deltec or its authorized agents.
 - Check appropriate medication stability for time and temperature to assure stability with actual pump delivery conditions.

Table of Contents

Warnings	iii
Cautions	vi
Section 1: General Description	1
Introduction	1
Indications	1
Epidural/Subarachnoid Administration	1
Symbols	3
Pump Diagram	4
Description of the Keys, Display, and Features	5
The Main Screen	8
Lock Levels	9
Security Codes	9
Lock Level Table	10
Section 2: Pump Setup and Programming	11
Installing or Replacing the Batteries	11
Watching Power Up	16
Changing to Lock Level 0 (LL0)	17
Programming the Pump: General Instructions	18
Delivery Method	19
Programming Screens	19
Programming for Continuous Delivery	21
Removing a Cassette	23
Attaching a Cassette	24
Priming the Tubing and Connecting to the Patient	26
Inserting the Tubing into the Air Detector	28
Setting the Lock Level for the Patient	30
Programming with Upper Limits, Adjusting Rate in Lock Level 1	31

Section 3: Operating the Pump	33
Starting the Pump	33
Stopping the Pump	33
Turning the Pump On/Off	34
Resetting the Reservoir Volume	34
Section 4: Biomed Functions	35
Overview: Accessing the Biomed Functions	35
Air Detector On/Off	36
Upstream Sensor On/Off	37
Section 5: Reference	39
Messages and Alarms, Alphabetical List	39
Cleaning the Pump and Accessories	43
Exposure to Radiation, Ultrasound, Magnetic Resonance Imaging (MRI), or Use near ECG Equipment	45
Technical Description	46
Specifications (Nominal)	47
Accuracy Test Results	51
Safety Features and Fault Detection	53
Software Safety Features	55
Data Handling Software Safety Features	56
Annual Functional Inspection and Testing Procedures	57
Inspection Procedures	57
Testing Procedures	58
Occlusion Pressure Range Tests	63
Accuracy Tests	66
Index	71
Limited Warranty	73

1.0 General Description

Introduction

The CADD-Legacy™ 1 ambulatory infusion pump provides measured drug therapy to patients in hospital or outpatient settings. Therapy should always be overseen by a physician or a certified, licensed healthcare professional. As appropriate to the situation, the patient should be instructed in using and troubleshooting the pump.

Indications

The CADD-Legacy™ 1 pump is indicated for intravenous, intra-arterial, subcutaneous, intraperitoneal, epidural space, or subarachnoid space infusion. The pump is intended for therapies that require a continuous rate of infusion.

Epidural/Subarachnoid Administration

The selected drug must be used in accordance with the indications included in the package insert accompanying the drug. Administration of any drug by this pump is limited by any warnings, precautions, or contraindications in the drug labeling.

Analgesics

Administration of analgesics to the epidural space is limited to use with indwelling catheters specifically indicated for either short-or long-term drug delivery.

Administration of analgesics to the subarachnoid space is limited to use with indwelling catheters specifically indicated for short-term drug delivery.

Anesthetics

Administration of anesthetics to the epidural space is limited to use with indwelling catheters specifically indicated for short-term drug delivery.

WARNING:

- Do not administer drugs to the epidural space or subarachnoid space unless the drug is indicated for administration to those spaces. Drugs not intended for epidural or subarachnoid space infusion could result in death or serious injury to the patient.
 - To prevent the infusion of drugs that are not indicated for epidural space or subarachnoid space infusion, do not use administration sets that incorporate injection sites. The inadvertent use of injection sites for infusion of such drugs could result in death or serious injury to the patient.
 - If a Medication Cassette™ Reservoir, CADD® Extension Set or CADD® Administration Set is used for drug delivery into the epidural or subarachnoid space, clearly differentiate them from those used for other routes of infusion, for example, by color coding, or other means of identification. Drugs not intended for epidural or subarachnoid space infusion could result in death or serious injury to the patient.
-
-

Symbols

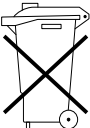
- ~ Alternating Current (Power Jack)
- ⊗ Accessory Jack
- ⚠ Attention, consult accompanying documents
(read *Instructions for Use*)
- Class II Equipment
- ♥ Type CF Equipment
- IPX4** Splashproof - water splashed against pump housing will have no harmful effects (see Cleaning the Pump and Accessories, Section 5, for additional important information)
- 📅 Date of Manufacture
- REF** Catalog (reorder) number
- SN** Serial Number
-  Dispose of used batteries in an environmentally safe manner, and according to any regulations which may apply.

General
Description

Pump Diagram

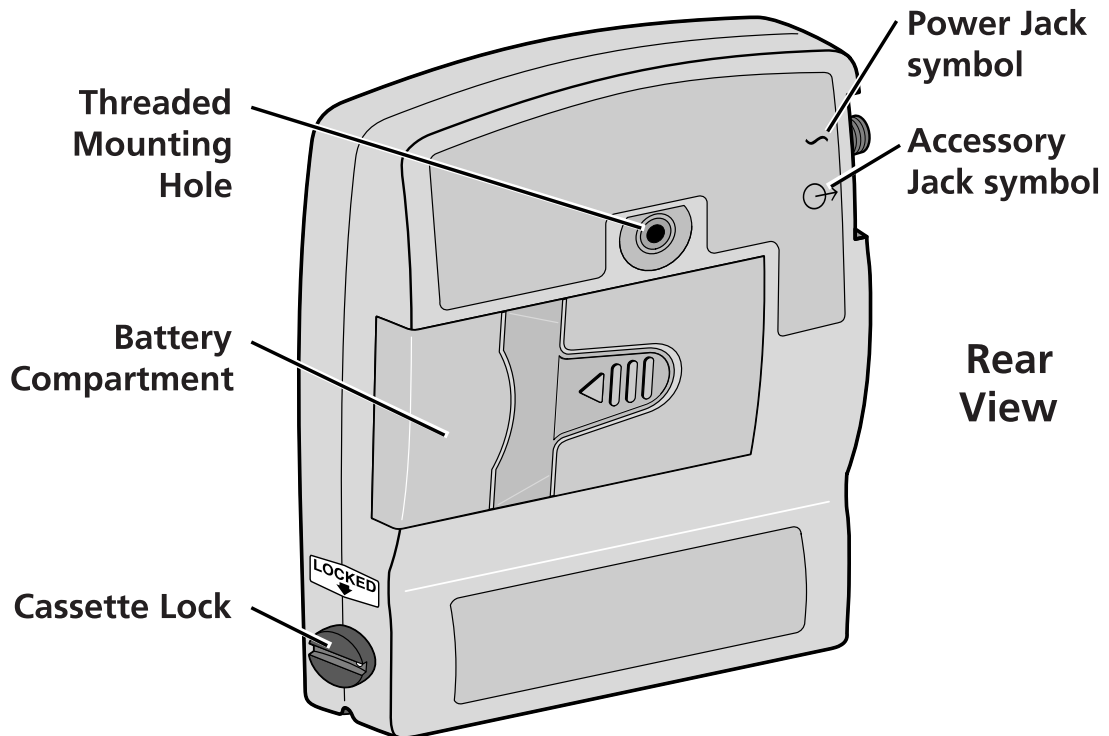
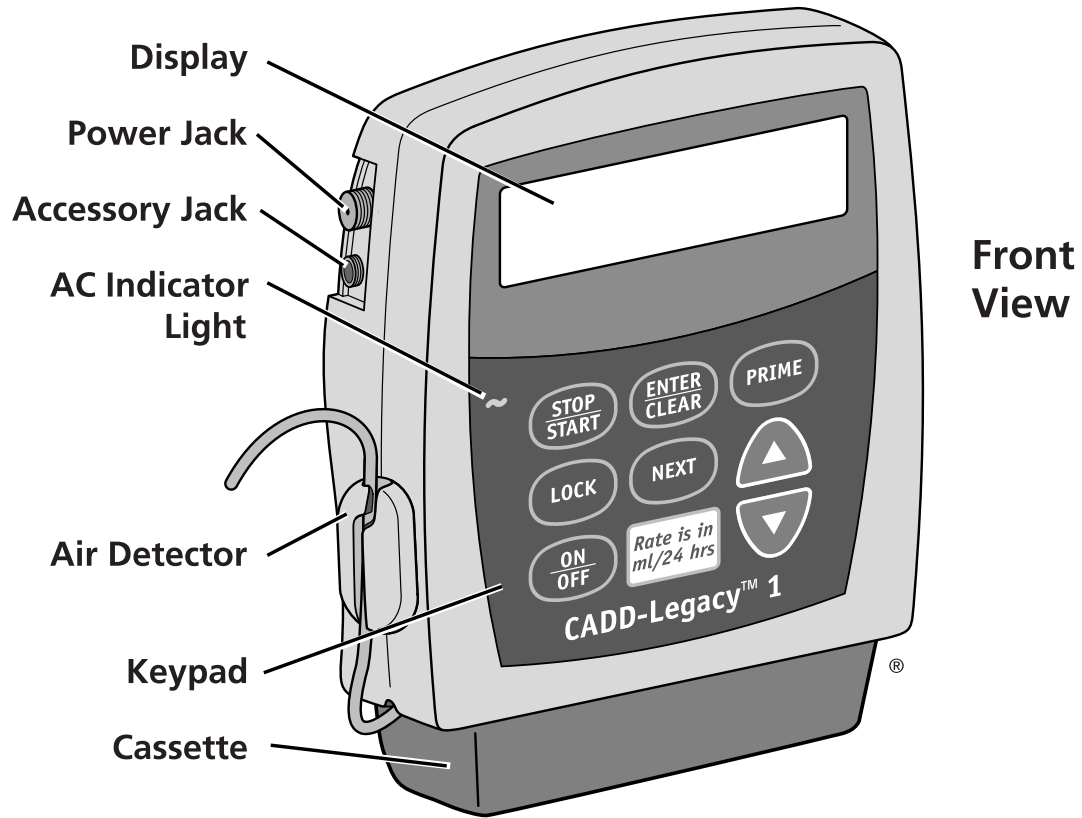

Description of the Keys, Display, and Features

AC Indicator Light









The green indicator light is on when you are using the AC adapter to power the pump.

Display

The Liquid Crystal Display (LCD) shows programming information and messages. In this manual, the term “display” is synonymous with display panel or LCD.

Keypad

The keys on the keypad are described below. A key beeps when pressed if it is operable in the current lock level.

-  starts and stops pump delivery; silences alarms.
-  is used to enter (save) a new value in the pump’s memory when programming pump settings or to clear values from record-keeping screens. It is also used to return from the Biomed Functions to the main screen (Section 4).
-  is used to fill the tubing and to remove air bubbles from the fluid path.
-  is used to view or change the pump’s current lock level. Lock levels are used to limit patient access to certain programming and operating functions. (See Lock Levels, this section.)
-  is used to move from one programming screen to the next without changing the setting or value displayed; silences alarms.
-  allows you to “scroll up” or increase a value, or scroll through Biomed Function settings.
-  allows you to “scroll down” or decrease a value, or scroll through Biomed Function settings.
-  is used to put the pump into a low power state when not in use or back into full power.

Power Jack

You may plug an AC Adapter into the Power jack as an alternate source of power. The indicator light on the front of the pump will illuminate when the AC Adapter is in use.

Accessory Jack

This jack is used for accessory cables. See the *Instructions for Use* supplied with those accessories.

Air Detector

The Air Detector is on the pump in the area shown in the diagram. If air is detected in the part of the tubing that passes through the Air Detector, an alarm sounds and delivery stops. (See Section 5 for Air Detector specifications.) If an Air Detector is not desired, it may be turned off. (See Section 4, Biomed Functions.)

WARNING: When the Air Detector is turned off, the pump will not detect air in the fluid path. Periodically inspect the fluid path and remove any air to prevent air embolism. Air embolism could result in death or serious injury to the patient.

Cassette

The cassette is the portion of the Medication Cassette™ Reservoir or CADD® Administration Set that attaches to the bottom of the pump. The following single-use products are compatible with the CADD-Legacy™ pump:

- Medication Cassette™ Reservoir (50 or 100 ml), used with the CADD® Extension Set with Anti-Siphon Valve
- CADD® Administration Set with integral Anti-Siphon Valve
- CADD® Administration Set with Add On Anti-Siphon Valve

WARNING: You must use a CADD® Extension Set with an Anti-Siphon Valve or a CADD® Administration Set with

either an integral or an Add On Anti-Siphon Valve to protect against unregulated gravity infusion that can result from an improperly attached cassette. Unregulated gravity infusion could result in death or serious injury to the patient.

Threaded Mounting Hole

The optional Polemount Bracket Adapter attaches to the threaded mounting hole in the back of the pump, allowing you to hang the pump on an IV pole.

Battery Compartment

Two AA batteries fit into the battery compartment. The AA batteries serve as the primary source of power, or as a backup when an AC Adapter is in use.

Cassette Lock

This attaches the cassette (the part of the Medication Cassette™ Reservoir or CADD® Administration Set that attaches to the pump) to the pump. This allows you to secure the cassette to the pump. If the cassette becomes unlocked while the pump is running, delivery will stop and an alarm will occur. If the cassette becomes unlocked while the pump is stopped, an alarm will occur.

Other Features Not Shown

Upstream Occlusion Sensor: The pump contains an upstream occlusion sensor. This feature may be turned on or off (see Section 4, Biomed Functions). When the sensor is turned on, and an upstream occlusion (between pump and fluid container) is detected, an alarm will sound, delivery will stop, and the display will show “Upstream Occlusion.”

WARNING: When the Upstream Occlusion Sensor is turned off, the pump will not detect occlusions upstream (between pump and fluid container). Periodically inspect the fluid container for decreasing volume, inspect the fluid path for kinks, a closed clamp, or

other upstream obstructions. Upstream occlusions could result in under- or non-delivery of medications. If undetected, these occlusions could result in death or serious injury to the patient.

Downstream Occlusion Sensor: The pump contains a downstream occlusion sensor. When a downstream occlusion (between the pump and patient access site) is detected, an alarm will sound, delivery will stop, and the display will show “High Pressure.”

Reservoir Volume Alarm: The Reservoir Volume alarm indicates when the fluid in the fluid container is low or depleted. Each time you change the fluid container, you may reset the Reservoir Volume to the originally programmed volume. Then, as medication is delivered, the Reservoir Volume automatically decreases. When the pump calculates that 5 ml remain in the fluid container, beeps sound and “ResVol Low” appears on the main screen. This alarm recurs at every subsequent decrease of 1 ml until the Reservoir Volume reaches 0 ml, at which point the pump stops and the Reservoir Volume empty alarm sounds.

The Main Screen

The main screen is the starting point for programming or viewing the pump’s settings.

If no keys are pressed for a period of time (2 minutes), the display reverts to the main screen. When the two AA batteries are low, “LowBat” appears on the main screen.

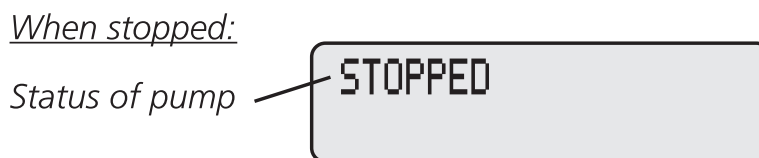
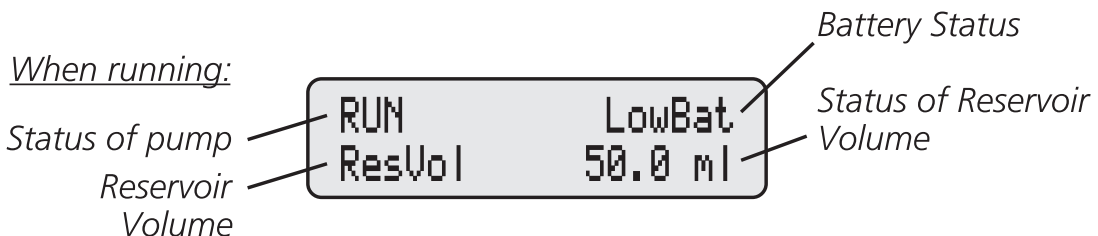

Lock Levels

Lock levels are used to limit patient access to certain programming and operating functions. The table on the next page lists the functions that are accessible in Lock Level 0 (LL0), Lock Level 1 (LL1), and Lock Level 2 (LL2). When a function is accessible, the key associated with the function beeps when pressed. If a function is not accessible, the pump ignores the key press and a beep does not sound. Section 2, Pump Setup and Programming, describes how to change the lock level.

Security Codes

The following security codes are preset by the manufacturer for the clinician's use:

**** text omitted from online version ****

WARNING: Do not disclose to the patient the pump's security codes or any other information that would allow the patient complete access to all programming and operating functions. Improper programming could result in death or serious injury to the patient.

Lock Level Table

This table lists the operations that are accessible in each lock level while the pump is stopped and running. LL0 permits complete access to all programming and operating functions. LL1 permits limited control of pump programming and operations. LL2 permits only minimal control of pump operations.

Pump Operations and Programming	Stopped			Running
	LL0	LL1	LL2	Any Lock Level
Stop/Start the pump	Yes	Yes	Yes	Yes
Reset Reservoir Volume	Yes	Yes	Yes	No
Prime	Yes	Yes	No	No
Change the lock level	Yes, w/code	Yes, w/code	Yes, w/code	No
Change Continuous Rate	Yes	Up to LL0 value	No	No
Clear Given amount	Yes	Yes	No	No
Biomed Functions				
Access to Functions	Yes, w/code	No	No	No
Air Detector On/Off	Yes, w/code	View only	View Only	View Only
Upstream Occlusion Sensor On/Off	Yes, w/code	View only	View Only	View Only

2.0 Pump Setup and Programming

Installing or Replacing the Batteries

Use new, AA alkaline batteries such as DURACELL® or EVEREADY® ENERGIZER® batteries. The pump retains all programmed values while the batteries are removed.

Dispose of used batteries in an environmentally safe manner, and according to any regulations which may apply.

WARNING:

- Do not use rechargeable NiCad or nickel metal hydride (NiMH) batteries. Do not use carbon zinc (“heavy duty”) batteries. They do not provide sufficient power for the pump to operate properly, which could result in death or serious injury to the patient.
- Always have new batteries available for replacement. If power is lost, nondelivery of drug will occur and, depending on the type of drug being administered, could result in death or serious injury to the patient.
- If the pump is dropped or hit, the battery door or tabs may break. Do not use the pump if the battery door or tabs are damaged because the batteries will not be properly secured; this may result in loss of power, nondelivery of drug, and, depending on the type of drug being administered, death or serious injury to the patient.

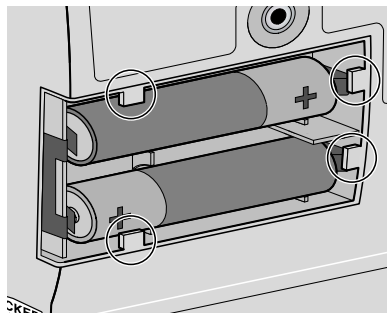

Section 2: Pump Setup and Programming

In order to install or replace the batteries, **be sure the pump is Stopped**. Then, follow these steps:

1. Push down and hold the arrow button while sliding the door off.

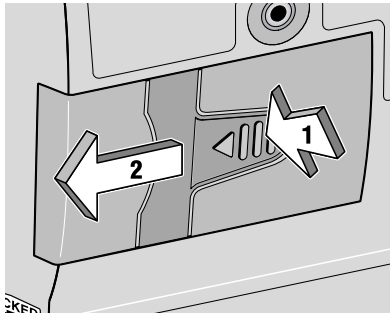

2. Remove the used batteries. Pulling on the end of the battery strap will make battery removal easier.
3. Install the new batteries in the compartment, making sure the battery strap is positioned correctly under the batteries.

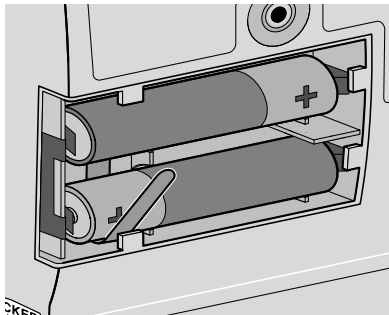

NOTE:

- *Be sure to match the polarity markings of the new batteries (+ and -) with those labeled in the battery compartment. If you put the batteries in backwards, the display panel will be blank, and you will not hear a beep.*

- *Use two new, AA alkaline batteries to power the pump. You may use any alkaline batteries, including DURACELL® Alkaline and EVEREADY® ENERGIZER® Alkaline, for example.*
4. Place the battery door over the battery compartment and slide the door closed.

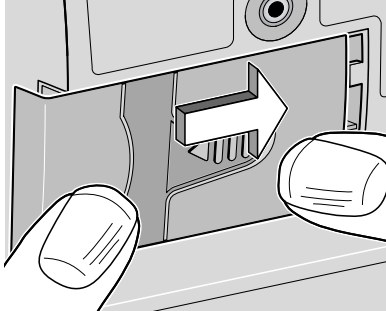

5. Ensure that the door is latched by trying to remove the door without pressing the arrow button.

NOTE: *The power-up sequence will start, the pump will go through an electronic self-test, and the pump will beep six times at the end of the power-up sequence. All of the display indicators, the software revision level, and each parameter will appear briefly.*

WARNING: If a gap is present anywhere between the battery door and the pump housing, the door is not properly latched. If the battery door becomes detached or loose, the batteries will not be properly secured; this could result in loss of power, nondelivery of drug, and, depending on the type of drug being administered, death or serious injury to the patient.

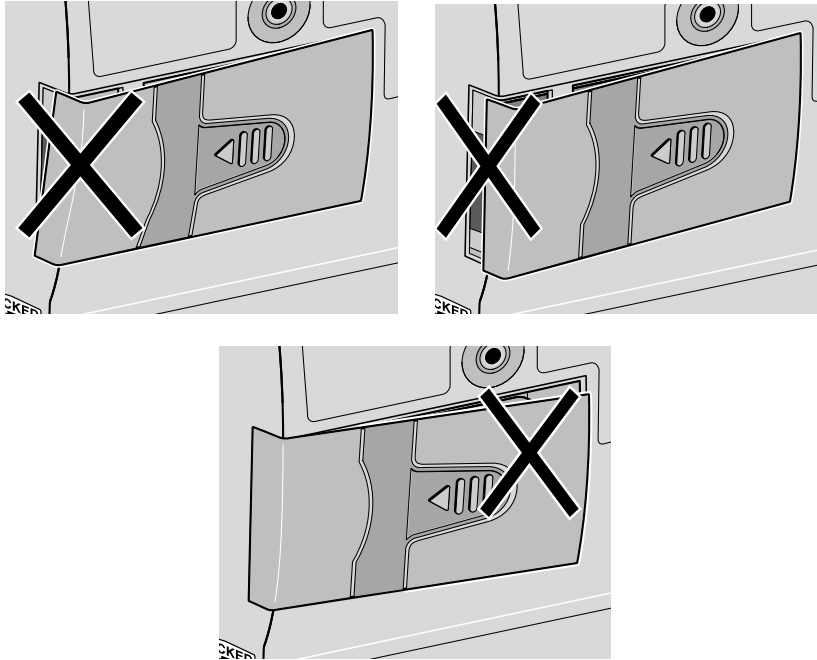

Pump Setup & Programming

- Resume operation of the current program by pressing and holding  to start the pump or proceed to program the pump.

NOTE:



- The life of the batteries is dependent on the amount of medication delivered, delivery rate, battery age, and the temperature.*
- At the rate of one 50 ml Medication Cassette™ Reservoir per day, alkaline batteries will usually last about seven days.*
- The power of the batteries will be quickly depleted at temperatures below +10°C (50°F).*

CAUTION: Do not store the pump for prolonged periods of time with the batteries installed. Battery leakage could damage the pump.

Watching Power Up

When you install the batteries, the pump will start its power up sequence during which it performs self-tests and displays programmed values. Watch for the following:

- Pump model number and last error code (“LEC”) if any, will appear.
- The software version will appear.
- The display will turn on, showing a series of blocks. Look for any blank areas, which would indicate a faulty display.
- The display will turn off briefly.
- The pump’s program screens will appear, followed by screens showing the Air Detector status, Upstream Occlusion sensor status, and lock level setting. The pump will beep after each screen. If messages appear, see the Messages and Alarms Table in Section 5 of this manual for further explanation and instruction.
- When power up is complete, six beeps will sound, and the pump will be stopped on the main screen.

***NOTE:** To move quickly through the power-up screens, press  repeatedly. To skip the automatic review entirely, press . If you attempt to skip screens before the pump is powered up, it will not respond.*

Changing to Lock Level 0 (LL0)

Before programming the pump, make sure the pump is set to LL0. LL0 allows the clinician to access all programming and operating functions.









1. Make sure the pump is stopped. Press **LOCK**. The current lock level will appear. (If the lock level is already LL0, press **NEXT** to exit.)
2. Press **▲** or **▼** until “LL0” appears.
3. Press **LOCK** again or **ENTER CLEAR**. “Code 0” will appear.
4. Press **▲** or **▼** until the Lock Level Code ******** appears.

WARNING: Do not disclose to the patient the pump’s security codes or any other information that would allow the patient complete access to all programming and operating functions. Improper programming could result in death or serious injury to the patient.

5. Press **LOCK** or **ENTER CLEAR** to set the new lock level.

Programming the Pump: General Instructions

The procedure for changing a programmed setting is similar for most programming screens.

- Make sure the pump is stopped and in Lock Level 0.
- To begin programming, start at the main screen and press .
- To change a setting, press  or  until the desired setting appears. (Press and hold these keys to change values with increasing speed.)
- Press  within 25 seconds to confirm a change or the screen will revert to the previous setting.
- If any key other than  is pressed, “Value not saved” will appear. Press  to return to the screen being programmed, scroll to the desired value, and press .
- Press  to advance to the next screen.
- To leave a setting unchanged, press  to go to the next screen.

Delivery Method

The CADD-Legacy™ 1 pump provides delivery in milliliters per 24 hours:

- Continuous Rate (up to 3000 ml per 24 hours)

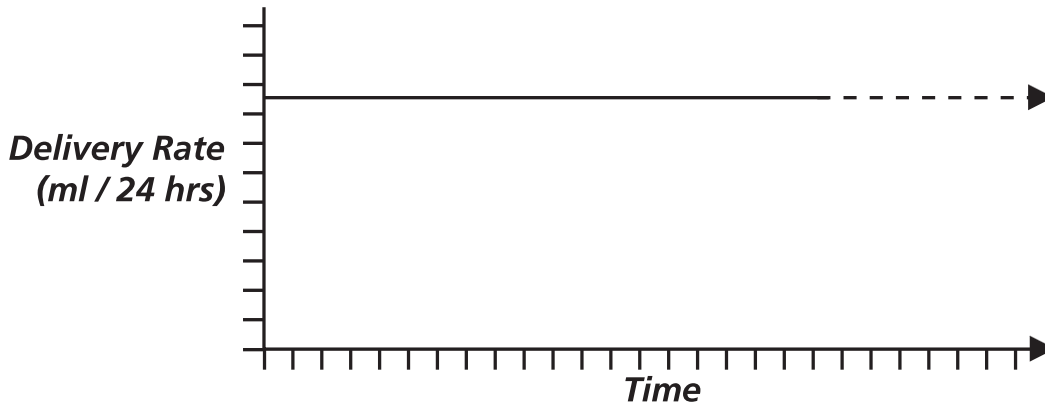

Pump Setup & Programming

Programming Screens

These are the programming screens for the CADD-Legacy™ 1 pump. Descriptions of the screens follow.

Reservoir Volume	Reservoir Volume 100.0 ml
Continuous Rate (ml/24 hr)	Continuous Rate 5 ml/24 hr
Given	Given 2.50 ml
Air Detector (Off, On-High, or On-Low)	Air Detector On-High
Upstream Sensor (Off or On)	Upstream Sensor On

Reservoir Volume

Enter the volume of fluid contained in a filled fluid container. The Reservoir Volume value decreases as the pump delivers fluid or as you prime the tubing. When you change the fluid container, reset the reservoir volume on this screen. If you do not wish to use the Reservoir Volume feature, scroll down to “Not In Use” (located before 1 and after 9999 in the range of values).

The reservoir volume could be set higher than the capacity of the fluid container. Be sure to program the reservoir volume to reflect the actual volume of the medication being used.

Continuous Rate

Enter the continuous rate of medication delivery in milliliters per 24 hours. The maximum rate is 3000 ml/24 hrs.

NOTE: If you intend to run the pump in Lock Level 1 so the Continuous Rate can be varied, you should enter the maximum allowable rate while programming in Lock Level 0. After programming, you may then change to Lock Level 1 and decrease the rate to its starting value. See Programming with Upper Limits, Adjusting Rate in LL1 at the end of Section 2.

Given

This screen shows the total amount of drug delivered since the last time this value was cleared. The amount shown is rounded to the nearest 0.05 ml. If this value reaches 99999.95, it automatically returns to 0 and continues counting. The Given amount does not include drug used when priming the tubing.

Air Detector Status

This screen indicates whether the Air Detector is on high sensitivity, low sensitivity or turned off. The Air Detector status cannot be changed without entering the Biomed Functions Code (see Section 4, Biomed Functions, to change the setting).











Upstream Sensor Status

This screen indicates whether the Upstream Occlusion Sensor is turned on or turned off. The Upstream Sensor status cannot be changed without entering the Biomed Functions Code (see Section 4, Biomed Functions, to change the setting).

Programming for Continuous Delivery

To program the pump, enter the prescribed values.

NOTE: Remember the pump is programmed in ml/24 hr.

1. **Begin at the main screen.**
 - Make sure the pump is in LL0.
 - Make sure STOPPED appears on the main screen.
 - Press  to begin.
2. **Enter the Reservoir Volume.**
 - Press  or  to select the volume of a filled fluid container. (If you do not wish to use the Reservoir Volume feature, scroll down to “Not In Use” located before 1.)
 - Press .
 - Press .
3. **Enter the Continuous Rate in ml per 24 hours.**
 - Press  or  to select the desired rate.
 - Press .
 - Press .
4. **Clear the Milliliters Given.**
 - Press  if you wish to clear the amount given.

- Press **◉** NEXT ◉.

5. Verify the Air Detector status.

- Make sure the desired setting is displayed. This screen will show whether the Air Detector is turned on (high or low) or off.

WARNING: When the Air Detector is turned off, the pump will not detect air in the fluid path. Periodically inspect the fluid path and remove any air to prevent air embolism. Air embolism could result in death or serious injury to the patient.

- If you need to change the Air Detector setting, see Section 4, Biomed Functions.

- Press **◉** NEXT ◉.

6. Verify the Upstream Occlusion Sensor status.

- Make sure the desired setting is displayed. This screen will show whether the Upstream Occlusion Sensor is turned on or off.

WARNING: When the Upstream Occlusion Sensor is turned off, the pump will not detect occlusions upstream (between pump and fluid container). Periodically inspect the fluid container for decreasing volume, inspect the fluid path for kinks, a closed clamp, or other upstream obstructions. Upstream occlusions could result in under- or non-delivery of medications. If undetected, these occlusions could result in death or serious injury to the patient.

- If you need to change the Upstream Occlusion Sensor setting, see Section 4, Biomed Functions.

- Press **◉** NEXT ◉.

7. Review the program.

Press **NEXT** repeatedly to review the programming screens. If you need to reprogram a setting, press **NEXT** until the appropriate screen appears and change the setting as described in this section.

Removing a Cassette

WARNING: Close the fluid path tubing with the clamp before removing the cassette from the pump to prevent unregulated gravity infusion, which could result in death or serious injury to the patient.

1. Stop the pump.
2. Close the tubing clamp.
3. Insert a coin into the lock and turn it clockwise. The lock will pop out when you unlock the cassette.
4. A continuous alarm will sound and the pump will display “No Disposable, Clamp Tubing.” The alarm may be silenced by pressing **STOP START** or **NEXT**.
5. Remove the cassette hooks from the pump hinge pins.

Attaching a Cassette

Obtain a new, filled Medication Cassette™ Reservoir, or CADD® Administration Set attached to a non-vented, flexible IV bag.

WARNING: For detailed instructions and warnings pertaining to the Medication Cassette™ Reservoir or CADD® Administration Set, please refer to the instructions for use supplied with the product for preparing the product for use.

After attaching the cassette, proceed to the Reservoir Volume screen to reset the value for the volume, and then prime the tubing.

WARNING: Frozen medication must be thawed at room temperature only. Do not heat the Medication Cassette™ Reservoir in a microwave oven as this may damage the medication, the Medication Cassette™ Reservoir, or cause leakage.

To attach the cassette to the pump

1. Clamp the tubing.
2. Insert the cassette hooks into the hinge pins on the pump.
3. Place the pump upright on a firm, flat surface. Press down so the cassette fits tightly against the pump.

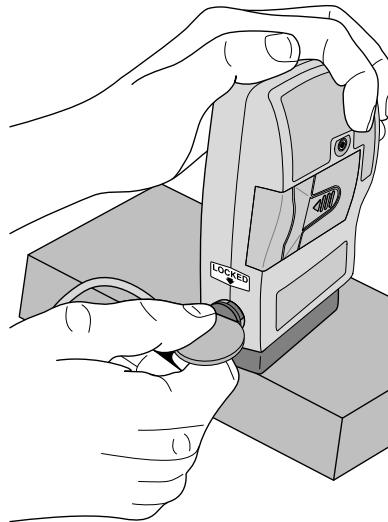

4. Insert a coin into the lock, push in, and turn counterclockwise until the line on the lock lines up with the arrow on the side of the pump and you feel the lock click into place.

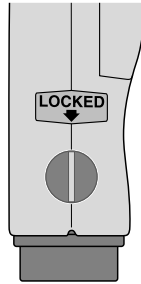

WARNING: Attach the cassette (the part of the Medication Cassette™ Reservoir or CADD® Administration Set that attaches to the pump) properly. An improperly attached or detached cassette could result in unregulated gravity infusion of medication from the fluid container or a reflux of blood, which could result in death or serious injury to the patient.

You must use a CADD® Extension Set with Anti-Siphon Valve or a CADD® Administration Set with either an integral or an Add On Anti-Siphon Valve to protect against unregulated gravity infusion that can result from an improperly attached cassette.

5. Gently twist, push, and pull on the cassette to make sure it is firmly attached. If the cassette is not secure, return to step 1.

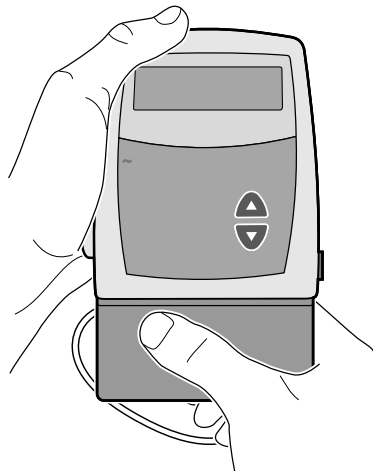

Priming the Tubing and Connecting to the Patient

The pump must be stopped and in LL0 or LL1 in order to prime the fluid path. If the pump is in LL2, you cannot prime the fluid path.

NOTE: If you are not changing the fluid container but wish to prime the fluid path, you may prime the pump as described below.

WARNING: Do not prime the fluid path with the tubing connected to a patient as this could result in overdosing of medication or air embolism, which could result in death or serious injury to the patient.

1. Make sure the tubing is disconnected from the patient and the tubing clamp is open.
2. Press and hold **PRIME**. You will hear a single beep, and the word “Prime” will appear on the display.
3. After “Prime” and three sets of dashes appear, and you hear three beeps, release **PRIME**.
4. Press and hold **PRIME** again to fill the fluid path and to eliminate air bubbles. The screen displays “Priming . . .” and you will hear a short beep each time the pump goes through a delivery cycle.

NOTE:

- *The air detector alarm is automatically disabled when priming.*
 - *Fluid delivered during priming is subtracted from the Reservoir Volume, but is not added to the Given screen since this fluid is not delivered to the patient.*
5. If the tubing is not yet fully primed, press and hold **PRIME** again. If the tubing is primed, press **NEXT** to return to the main screen.

*NOTE: Each time you press and hold **PRIME**, you pump a maximum of 1.0 ml of fluid into the tubing. The pumping action will stop automatically when 1.0 ml has been delivered. If all of the air has not been removed from the fluid path, repeat the above priming procedure.*

6. If the Air Detector is in use, go to the next section. If not, connect the tubing to the patient's infusion set or indwelling catheter and go to Setting the Lock Level for the Patient.

WARNING: Ensure that the entire fluid path is free of all air bubbles before connecting to the patient to prevent air embolism. Air embolism could result in death or serious injury to the patient.

NOTE: If the fluid path contains an air eliminating filter, it is acceptable for air bubbles to be present on the vent side of the filter.

Inserting the Tubing into the Air Detector

WARNING: When the Air Detector is turned off, the pump will not detect air in the fluid path. Periodically inspect the fluid path and remove any air to prevent air embolism. Air embolism could result in death or serious injury to the patient.

(See Section 4, Biomed Functions, for instructions on how to turn the air detector on and off.)

1. If the Air Detector is in use, make a small loop of tubing underneath the air detector and hold it with your thumb.
2. Place the tubing over the groove in the air detector and tuck it under the catch.

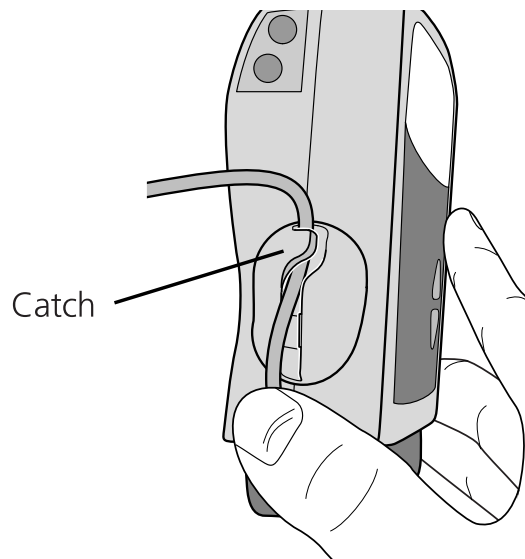

3. To seat the tubing into the groove, gently pull the tubing upward, until it is under the retention nubs and flat in the groove.

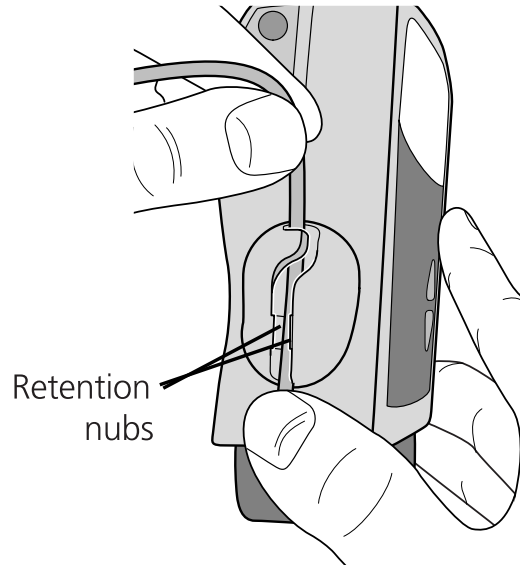

4. Connect the tubing to the patient's infusion set or indwelling catheter.

WARNING: Ensure that the entire fluid path is free of all air bubbles before connecting to the patient to prevent air embolism. Air embolism could result in death or serious injury to the patient.









NOTE: If the fluid path contains an air eliminating filter, it is acceptable for air bubbles to be present on the vent side of the filter.

Setting the Lock Level for the Patient

The Lock Level must be changed to LL1 or LL2 to prevent the patient from having complete access to all programming and operating functions.

NOTE: You may change the lock level at any time by stopping the pump and following the procedure below.

To change the lock level

1. Press .
2. The current lock level will appear.
3. Press  or  until the desired lock level (LL1 or LL2) appears.
4. Press  again or . “Code 0” will appear.
5. Press  or  until the Lock Level Code ******** appears.
6. Press  or  to set the new lock level.

WARNING: Do not disclose to the patient the pump’s security codes or any other information that would allow the patient complete access to all programming and operating functions. Improper programming could result in death or serious injury to the patient.

Programming with Upper Limits, Adjusting Rate in Lock Level 1





If a prescription allows for the Continuous Rate to be adjusted during the course of therapy, you may wish to operate the pump in LL1. Then, when necessary, you can adjust the Continuous Rate up to the maximum value that was programmed in LL0.

Programming the pump to use this feature

1. During initial programming in LL0, enter the **upper limit** value for the Continuous Rate. (This will be the maximum value when the pump is in LL1.)
2. After you are finished programming, change the lock level to LL1.
3. Decrease the Continuous Rate to its starting value, then press .

Adjusting the rate while the pump is in use

If it becomes necessary to increase the Continuous Rate during the course of therapy, stop the pump but *remain in LL1*.

1. Press  until the Continuous Rate screen appears.
2. Press  or  to select the desired value, then press .
3. Restart the pump if appropriate.

3.0 Operating the Pump

Starting the Pump

When you start the pump, programmed values will be automatically reviewed. Then fluid delivery will begin as programmed, and “RUN” will appear on the main screen. **If the pump will not start**, a message will appear on the display. Refer to the Messages and Alarms Table in Section 5.

WARNING: Prior to starting infusion, inspect the fluid path for kinks, a closed clamp, or other upstream obstructions, and remove any air to prevent air embolism. An undetected upstream occlusion may result in under- or non-delivery of medication, and, depending upon the type of medication being delivered, could result in death or serious injury to the patient. Air embolism could result in death or serious injury to the patient.

To start the pump

1. Press and hold .

Three sets of dashes appear on the display; then they disappear one-by-one, each accompanied by a single beep.

2. Release  after the last set of dashes disappears, and the pump beeps. All of the programming screens appear for your review one after the other.

Stopping the Pump

Stopping the pump stops delivery. When the pump is stopped, STOPPED will appear on the main screen, and you will hear three beeps every 5 minutes.

To stop the pump

1. Press and hold .

Three sets of dashes will appear one-by-one on the pump's display, each accompanied by a single beep.

2. Release  after the third set of dashes appears and the pump beeps.

Turning the Pump On/Off

When the pump is stopped, you may put the pump into a low power state by turning it off. The pump may be turned off when it is disconnected from the patient and it is going to be stored for short periods of time.

CAUTION: Do not store the pump for prolonged periods of time with the batteries installed. Battery leakage could damage the pump.

To turn the pump off

- Press and hold .



Three sets of dots will appear one-by-one on the pump's display, each accompanied by a single beep.

To turn the pump on

- Press and hold . The pump will power up and automatically review all screens.

Resetting the Reservoir Volume

To reset the Reservoir Volume to the value programmed in LL0, the pump may be in any lock level.







1. Stop the pump.
2. Press  to display the Reservoir Volume screen.
3. Press  to reset the volume to the programmed value.

4.0 Biomed Functions

Overview: Accessing the Biomed Functions

The Biomed Functions are pump configurations that are less frequently changed. The Biomed Functions are accessible only when the pump is stopped and in Lock Level 0.



To Access the Biomed Functions

1. Press . The current lock level will appear.
2. Press  or . “Code 0” will appear.
3. Press  or  until the Biomed Functions Code ****text omitted from online version****. Then press  or .

WARNING: Do not disclose to the patient the pump’s security codes or any other information that would allow the patient complete access to all programming and operating functions. Improper programming could result in death or serious injury to the patient.

4. Press  to select the setting you wish to view or change, then follow the instructions in this section for the appropriate screen.





NOTE: To leave a Biomed Function unchanged, press .

5. To exit the Biomed Functions, press  until you get to the screen that reads, “NEXT for Biomed, ENTER for main.”
6. Press  to return to the main screen.

Air Detector On/Off

The Air Detector screen can be set to On-High, On-Low or Off.





WARNING: When the Air Detector is turned off, the pump will not detect air in the fluid path. Periodically inspect the fluid path and remove any air to prevent air embolism. Air embolism could result in serious injury or death to the patient.

1. With the pump stopped and in LL0, access Biomed Functions. (Refer to the beginning of the Biomed Functions section for instructions on how to access Biomed Functions.)
2. Press  until “Air Detector” appears.
3. Use  or  to select On-High, On-Low, or Off.
 - On-High is the highest sensitivity, where the smallest bubbles will be detected.
 - On-Low is lower sensitivity, where only the larger bubbles will be detected. See Specifications in Section 5.
4. Press  to enter the change.
5. Press  to go to the next screen.

Upstream Sensor On/Off

The Upstream Occlusion Sensor screen can be set to On or Off. If this screen is set to On, and an upstream occlusion (between pump and fluid container) is detected, an alarm will sound, delivery will stop, and the display will show “Upstream Occlusion.”

WARNING: When the Upstream Occlusion Sensor is turned off, the pump will not detect occlusions upstream (between pump and fluid container). Periodically inspect the fluid container for decreasing volume, inspect the fluid path for kinks, a closed clamp, or other upstream obstructions. Upstream occlusions could result in under- or non-delivery of medications. If undetected, these occlusions could result in death or serious injury to the patient.

1. With the pump stopped and in LL0, access Biomed Functions. (Refer to the beginning of the Biomed Functions section for instructions on how to access Biomed Functions.)
2. Press  until “Upstream Sensor” appears.
3. Press  or  to select Off or On.
4. Press  to enter the change.

5.0 Reference

Messages and Alarms, Alphabetical List

Messages and Alarms	Description / Corrective Action
---------------------	---------------------------------

Air In Line Detected TWO-TONE ALARM	<p>The Air Detector has detected air in the fluid path; the fluid path may contain air bubbles, or the tubing may not be fully threaded through the Air Detector. Press  or  to silence the alarm, then:</p> <ul style="list-style-type: none"> • Make sure the tubing is threaded properly. • If the fluid path contains air bubbles, close the clamps and disconnect the fluid path from the patient. Then follow the instructions for removing air by priming the pump, described in Section 2. Restart the pump.
---	--



Battery Depleted TWO-TONE ALARM	<p>The battery power is too low to operate the pump. The pump is now stopped.</p> <ul style="list-style-type: none"> • Change the batteries immediately. • Press and hold  to restart the pump.
---	---

Battery Removed Pump won't run TWO-TONE ALARM	<p>With the AC adapter attached, the AA batteries have been removed while the pump is running, or you have tried to start the pump with depleted batteries. The pump is now stopped. Press  or  to silence the alarm. Reinstall batteries or install new batteries. Press and hold  to restart the pump.</p>
---	---

Messages and Alarms	Description / Corrective Action
---------------------	---------------------------------









<p>[NO MESSAGE] TWO-TONE ALARM</p>	<p>With no AC adapter attached, the batteries have been removed while the pump is running. The pump is now stopped and unpowered. Install batteries to silence the alarm.</p> <p>OR</p> <p>Batteries were removed within approximately 15 seconds after stopping the pump. Install new batteries to silence the alarm, if desired. Otherwise, the alarm will stop within a short period of time.</p>
--	--

<p>Error TWO-TONE ALARM</p>	<p>An error has occurred. Remove the pump from service and contact Customer Service to return the pump for service.</p>
--	---

<p>High Pressure TWO-TONE ALARM</p>	<p>The pump has detected high pressure, which may be resulting from a downstream blockage, kink in the fluid path, or a closed tubing clamp. Remove the obstruction to resume operation. Or, press  or  to stop the pump and silence the alarm for 2 minutes, then remove the obstruction and restart the pump.</p>
--	--

<p>Key pressed, Please release TWO-TONE ALARM</p>	<p>If a key is being pressed, stop pressing it. If the alarm persists, close the tubing clamp and remove the pump from use. Contact Customer Service to return the pump for service.</p>
--	--

<p>LowBat THREE TWO-TONE BEEPS EVERY 5 MINUTES</p>	<p>The batteries are low, but the pump is still operable.</p> <ul style="list-style-type: none"> • Change the batteries soon.
---	--

Messages and Alarms	Description / Corrective Action
Motor Locked, remove all power TWO-TONE ALARM	Batteries are depleted and the pump was powered up with the AC Adapter. Install new AA batteries, reconnect the AC adapter, and restart the pump.
No Disposable, Clamp Tubing TWO-TONE ALARM	The disposable (CADD [®] Administration Set or Medication Cassette [™] Reservoir) was removed. Clamp the tubing immediately. A CADD [®] Administration Set or Medication Cassette [™] Reservoir must be properly attached in order for the pump to run. Press  or  to silence the alarm.
No Disposable, Pump won't run TWO-TONE ALARM	You have tried to start the pump without a disposable (CADD [®] Administration Set or Medication Cassette [™] Reservoir) attached. A CADD [®] Administration Set or Medication Cassette [™] Reservoir must be properly attached in order for the pump to run. Press  or  to silence the alarm.
Power lost while pump was on TWO-TONE ALARM	The pump was on and running when power was removed. Stop the pump before changing the battery or removing the power source. Press  or  to silence the alarm.
Reservoir Volume Empty TWO-TONE ALARM	The Reservoir Volume has reached 0.0 ml. Press  or  to stop the alarm. Then install a new fluid container if appropriate and reset the reservoir volume.
RUN ResVol Low THREE SINGLE BEEPS	The Reservoir Volume is low. Change the fluid container soon. See Reservoir Volume Alarm in Section 1 for more information.

Messages and Alarms	Description / Corrective Action
---------------------	---------------------------------

Service Due	Service is due for this pump based on clock battery age or total motor revolutions. This screen will appear while in LL0 only for 60 days and then in all lock levels until returned for service.
--------------------	---

TWO-TONE ALARM

Upstream Occlusion	Fluid is not flowing from the fluid container to the pump. Check for a kink in the tubing or a closed clamp between the fluid container and pump. Press ○NEXT or ○STOP START to stop the pump and silence the alarm for 2 minutes, then remove the obstruction and press ○STOP START to restart the pump.
---------------------------	--

TWO-TONE ALARM

Value not saved	A value was not saved by pressing ○ENTER CLEAR . Press ○NEXT to resume programming. Verify all programming screens before moving to the next screen or starting the pump.
------------------------	---

Cleaning the Pump and Accessories

CAUTION:

- Do not immerse the pump in cleaning fluid or water. Do not allow solution to soak into the pump, accumulate on the keypad, or enter the battery compartment. Moisture build-up inside the pump may damage the pump.
 - Do not clean the pump with acetone, other plastic solvents, or abrasive cleaners, as damage to the pump may occur.
-

Routinely clean the pump to keep it free of dirt, liquids, and foreign objects.

Use any of the following solutions to clean the pump and accessories:

- Soap solution
 - Benzalkonium Chloride concentrate (0.13%)
 - Glutaral Concentrate, USP (2%)
 - 10 percent solution of household bleach (one part household bleach to nine parts water)
 - Alcohol, USP (93%)
 - Isopropyl Alcohol, USP (99%)
 - Chlorohexidine (70%)
 - PDI — Super Sani-Cloth®
 - Mada Medical — MadaCide
1. Dampen a soft, lint-free cloth with cleaning solution and wipe the exterior surface of the pump. *Do not allow the solution to soak into the pump.*
 2. Wipe the entire surface dry with another soft, lint-free cloth. Allow the pump to dry completely before use.

Cleaning the Battery Contacts

Routinely clean the battery contacts, possibly as part of the preventative maintenance cycle, to remove buildup of foreign material on the contacts.

Use the following to clean the battery contacts:

- Cotton swab wetted with Isopropyl Alcohol (70% minimum)

NOTE: Do not use an alcohol formulation that contains components other than alcohol and water.

OR

- Pre-moistened alcohol swab
 1. Using a swab wetted with alcohol, rub the entire battery contact for a minimum of ten back and forth cycles (twenty total wipes over the contact).
 2. Using a clean surface of the swab, repeat process for second battery contact.
 3. Using a clean swab wetted with alcohol, rub each battery contact again, a minimum of four back and forth cycles (eight total wipes over the contact).
 4. Allow the contacts to dry completely before use.

Exposure to Radiation, Ultrasound, Magnetic Resonance Imaging (MRI), or Use near ECG Equipment

CAUTION:

- Do not expose the pump to therapeutic levels of ionizing radiation as permanent damage to the pump's electronic circuitry may occur. The best procedure to follow is to remove the pump from the patient during therapeutic radiation sessions. If the pump must remain in the vicinity during a therapy session, it should be shielded, and its ability to function properly should be confirmed following treatment.
 - Do not expose the pump directly to ultrasound, as permanent damage to the pump's electronic circuitry may occur.
 - Do not use the pump in the vicinity of magnetic resonance imaging (MRI) equipment as magnetic fields may adversely affect the operation of the pump. Remove the pump from the patient during MRI procedures and keep it at a safe distance from magnetic energy.
 - Do not use the pump near ECG equipment as the pump may interfere with the operation of the equipment. Monitor ECG equipment carefully when using this pump.
-

Technical Description

Standards used in Development of the Pump

The following standards were used in whole or part in the development of the pump.

Medical Electrical Equipment

IEC 60601-1, Medical Electrical Equipment, Part 1: General Requirements for Safety.

IEC 60601-1-1, Medical Electrical Equipment, Part 1: General Requirements for Safety. Collateral Standard: Safety requirements for medical electrical systems.

IEC 60601-1-2 (1993), General Requirements for Safety, Part 2: Electromagnetic Compatibility — Requirements and Tests.

IEC 60601-1-2, (2nd Edition, 01-June-1996) Medical Electrical Equipment, Part 1: General Requirements for Safety. 2. Collateral Standard: Electromagnetic Compatibility — Requirements and Tests.

IEC 60601-1-4, Medical Electrical Equipment, Part 1: General Requirements for Safety — 4. Collateral standard: Programmable electrical medical systems.

IEC 60601-2-24, Medical Electrical Equipment, Part 2: Particular Requirements for the Safety of Infusion Pumps and Controllers.

Electromagnetic Compatibility

RTCA/DO -160C, Radiated Emissions Only, Category A & Z Limit.

CISPR11, Radiated and Conducted Emissions, Group 1, Class B.

CISPR14, Radiated and Conducted Emissions, device powered by AC adapter only.

For CISPR11 and CISPR14 tests, the pump was fitted with an administration set with its inlet connected to a 250 ml bag and its outlet routed back to the bag forming a closed loop system. A total of six feet of tubing was used to form the closed loop.

IEC 61000-3-2, Harmonic Distortion, Class A equipment, only for devices powered @ 220 VAC or greater.

- IEC 61000-3-3, Voltage Functions and Flicker, only for devices powered @ 220 VAC or greater.
- IEC 61000-4-2, 8 kV contact discharge, 15 kV air discharge.
- IEC 61000-4-3, Radiated Susceptibility, 26 MHz to 2500 MHz, 10 V/m, 1 kHz – 80% AM modulation.
- IEC 61000-4-4, AC Fast Transients, at ± 500 volts, ± 1000 volts, and ± 2000 volts – AC mains plug.
- IEC 61000-4-5, AC Surges, 1 kV differential mode, 2 kV common mode.
- IEC 61000-4-6, Conducted Disturbances, AC mains plug, 3V, 150 kHz - 80 MHz.
- IEC 61000-4-8, AC Magnetic field, at 400 Amperes/meter at 50 Hz.
- IEC 61000-4-11, AC Steady State, Dropout & Slow Sags/Surges.
- ENV 50204, Digital Radio Telephone, 10 V/m, 900 ± 5 MHz, 50% duty cycle and 200 rep. frequency.

Specifications (Nominal)

General Pump Specifications

- Resolution Medication Cassette™ Reservoir or CADD® Administration Set, 0.050 ml per pump stroke nominal
- Size 4.1 cm × 9.5 cm × 11.2 cm [1.6 in. × 3.8 in. × 4.4 in.] excluding cassette or other accessories
- Weight 392 g [13.8 oz.] including two AA batteries, empty 100 ml Medication Cassette™ Reservoir, excluding other accessories
- Classification
(IEC 601-1) CF , Class II
- Moisture Protection Splashproof (IPX4)

Pump Alarms Low battery power; depleted battery power; battery dislodged; pump stopped; pump fault; low reservoir volume; high delivery pressure; air in line; disposable not attached when run attempted; motor locked; upstream occlusion; reservoir volume empty; key stuck; disposable detached.

Maximum Infusion Pressure 40.0 psi [2.76 bar]

Maximum Time to Occlusion Alarm CADD® Administration Set with anti-siphon valve: 2.0 hours

Bolus Volume at Occlusion Alarm Pressure 0.050 ml resolution CADD® Administration Sets/Medication Cassette™
Reservoirs: <0.15 ml

Power Sources Two AA alkaline batteries ; AC Adapter.
The expected life of two AA batteries is 15 hours at 125 ml/hour, or approximately 14 days at 10 ml/day (nominal). This estimate is based on laboratory tests conducted at room temperature using two new batteries. Actual battery life will vary depending on the brand of battery, battery shelf life, temperature conditions, and delivery rate. It is recommended that two new AA batteries be kept available for replacement if necessary.

An internal battery powers the clock. When it is depleted, it cannot reliably maintain the clock time. This battery must be replaced by the manufacturer. The internal battery has an expected life of 5 years.

System Operating	
Temperature	+2°C to 40°C (35°F to 104°F)
System Storage	
Temperature	-20°C to 60°C (-4°F to 140°F)
System Delivery	
Accuracy	± 6% (nominal). At low infusion rates, this accuracy may not be achieved for short periods. During the total infusion time, the accuracy averages out (see accuracy curves, pages 51 and 52)
System Definition	System is defined as a CADD-Legacy™ pump with an attached Medication Cassette™ Reservoir and CADD® Extension Set with integral anti-siphon valve, or an attached CADD® Administration Set with integral or add-on anti-siphon valve.
High Pressure Alarm	26 ± 14 psi [1.79 ± 0.97 bar].
Air Detector Alarm	Single bubble Low sensitivity = greater than 0.250 ml High Sensitivity = greater than 0.100 ml Multi-bubble = 1.0 ml nominal
Maximum Volume Infused under Single Fault Condition	
	CADD® Administration Set with anti-siphon valve: 0.2 ml
Delivery Rate during priming	Approx. 180 ml/hr
Alarm Disabled during priming	Air Detector

Continuous Delivery Specifications

- Reservoir Volume 1 to 9999 or Not In Use; programmable in 1 ml increments, displayed in 0.1 ml increments
Default: 1.0 ml
- Continuous Rate 1 to 3000 ml / 24 hr; programmable in 1 ml / 24 hr increments
Default: 1.0 ml
- Given 0 to 99999.95 in 0.05 ml increments

Biomed Functions

- Air Detector Off
On-Low
On-High
Default: On-High
- Upstream Sensor Off
On
Default: On

Accuracy Test Results

The following graphs are designed to show flow accuracy of the infusion system plotted against given time periods.

Flow rate immediately following startup

Time Interval: 0.5 min
 Total Time: 120 min
 Programmed Rate: 24.0000 ml/hr
 Cassette used: CADD® Administration Set with anti-siphon valve

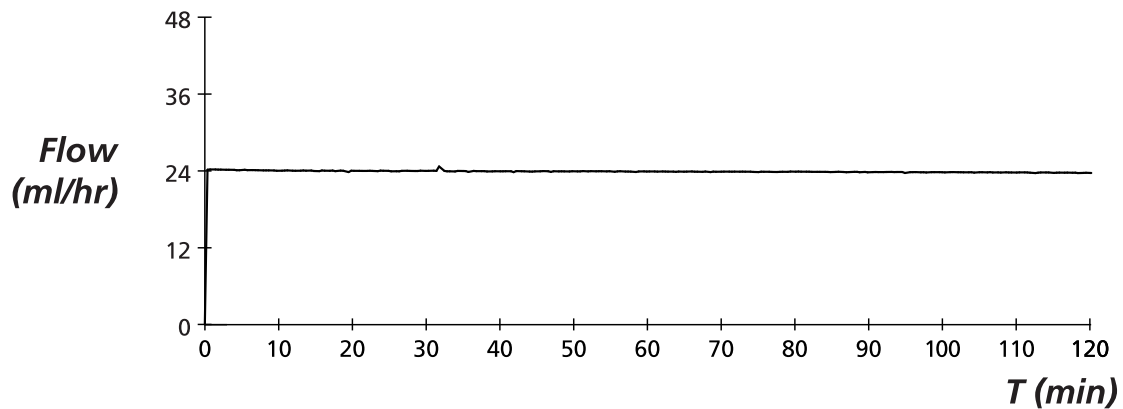

Short term flow rate error

Programmed Rate: 24.0000 ml/hr
 Average Flow Rate: 23.9227 ml/hr
 Mean Flow Error: -0.32%
 Cassette used: CADD® Administration Set with anti-siphon valve

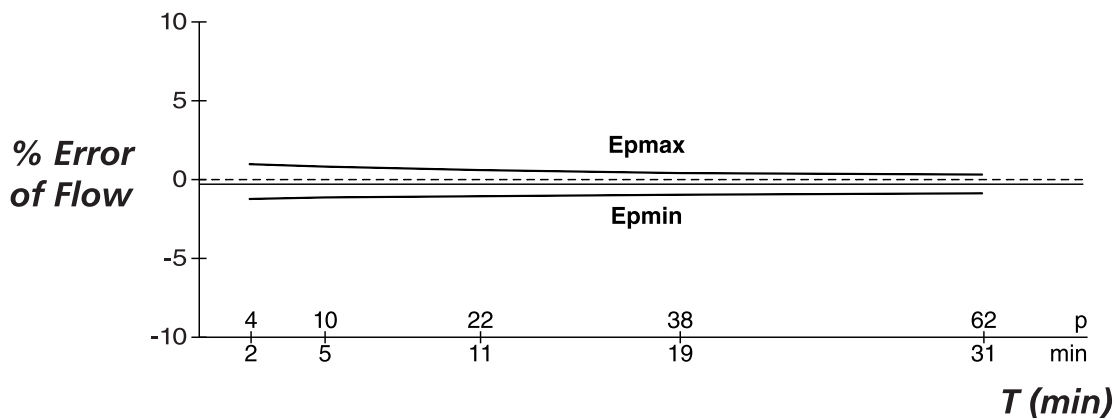

Reference

Flow rate immediately following startup

Time Interval: 15 min
 Total Time: 1500 min
 Programmed Rate: 0.1 ml/hr
 Cassette Used: CADD[®] Administration Set with anti-siphon valve

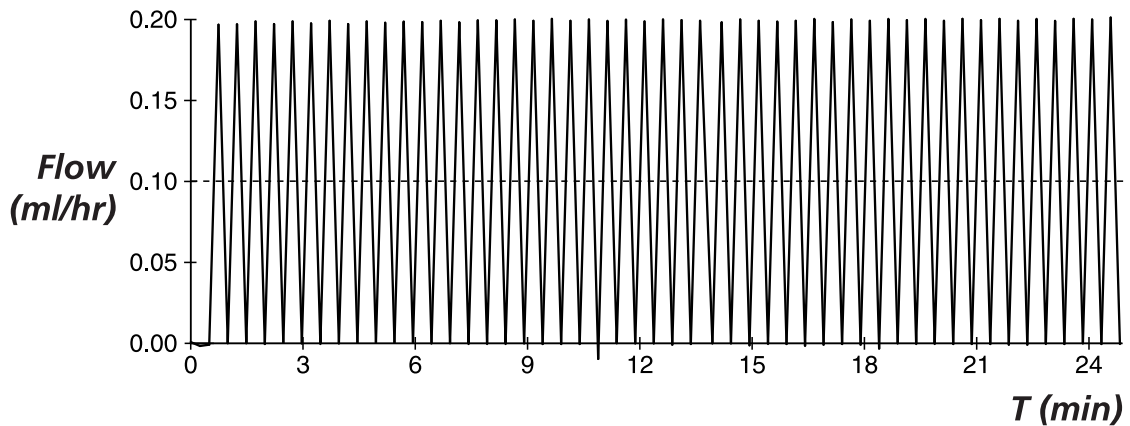

Short term flow rate error

Programmed Rate: 0.1 ml/hr
 Average Flow Rate: 0.0989 ml/hr
 Mean Flow Error: -1.05%
 Cassette Used: CADD[®] Administration Set with anti-siphon valve

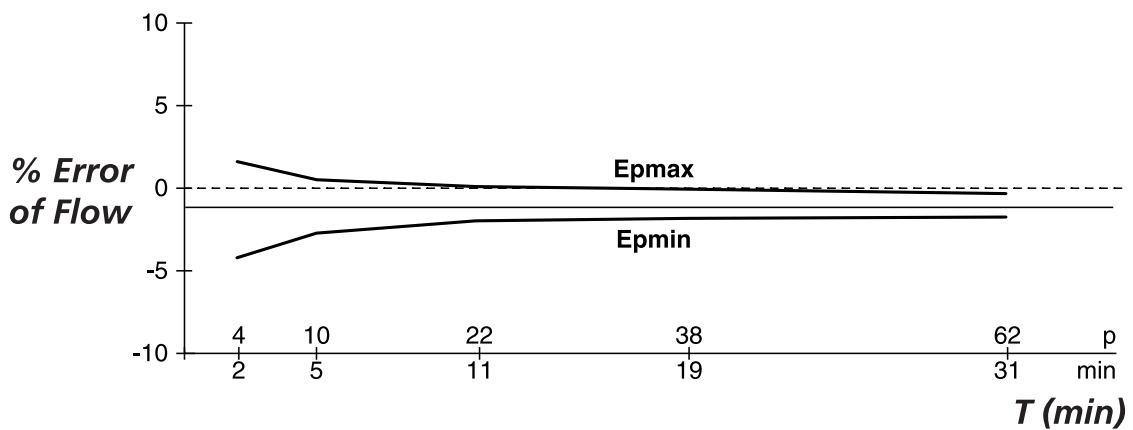

Reference

Safety Features and Fault Detection

Hardware Safety Features

Key hardware safety features include a watchdog timer circuit, motor driver and motor watchdog circuits, and a voltage detector circuit. Each safety circuit performs a unique function to insure the overall safety of the device.

Watchdog Timer Circuit

The microprocessor must send an appropriate signal to the watchdog circuit at least once per second. If the microprocessor does not, the watchdog circuit will time out and shut down the pump controller.

Watchdog timer circuitry is provided to monitor the status of the microprocessor and disable the motor and enable the audible alarm if the microprocessor fails to function properly. The microprocessor must strobe the watchdog circuit at least once every second in order to prevent the watchdog from performing its reset function. The reset output from the watchdog circuit is a pulse output. This acts to “jump start” the microprocessor. This unique feature allows the microprocessor to test the watchdog circuit on every power-up.

By setting a flag in the memory and not strobing the watchdog, the microprocessor can force a watchdog time-out. After being reset, the microprocessor checks the status flag to see if this was a time-out test. If so, the microprocessor continues normal power-up activities. If the reset occurred when the microprocessor was not expecting it, the microprocessor traps the event, sounds the audible alarm and displays an error message on the LCD.

Motor Driver/Motor Watchdog Circuit

Motor drive circuitry is composed of a series of power FET transistors, passive components, and two voltage comparators. Built into the motor drive circuitry is an RC timer which times how long the motor runs each time it is turned on. If the motor runs for more

than an average of 3 seconds, the circuit will time out and disable the motor. A unique feature of this circuit is that control lines to and from the microprocessor circuit allow the microprocessor to perform a complete functional test of the motor drive circuit without running the motor. The microprocessor performs this test function every several minutes to assure its continued functionality. An input from the watchdog circuit prevents motor operation if the watchdog timer expires. The software verifies this function during the watchdog test described above.

Voltage Detector Circuit

Low voltage detection is performed by part of the Watchdog Circuit and by the microprocessor via software. Three low voltage levels are detected. The first two levels are detected by software and the third by hardware. The first level to be reached is the Low Battery Warning threshold which occurs when the battery voltage decays to a nominal value of 2.4 volts when the motor is off or 1.8 volts when the motor is active. An Analog to Digital Converter (ADC) built into the microprocessor allows the microprocessor, via software, to monitor the battery voltage. At the Low Battery Warning threshold, the microprocessor enables a periodic series of beeps and displays a low battery warning message on the LCD. As the voltage operating the motor reaches a nominal value of 4.75 volts, the software disables delivery, places a battery depleted message on the LCD, and enables a constant two tone audible alarm. When the battery voltage decays to a nominal value of 1.0 volts, a hardware reset circuit is triggered which places the microprocessor in reset. This prevents ambiguous microprocessor operation when the battery voltage continues to decay. The hardware reset continues until the battery is completely discharged or until it is removed. Once the pump controller goes into low battery shutdown, only replacing the depleted batteries with new ones will clear the condition.

Software Safety Features

Hardware-related Software Safety Features

Program Memory Check

At power up and at regular intervals thereafter, the program memory is tested by calculating a Cyclic Redundancy Code (CRC) on the program and then comparing it with the CRC stored with the program.

If the stored and calculated CRCs do not match, the software will display a system fault screen, turn on a continuous two-tone audible alarm, and stop all drug delivery.

RAM Memory Check



At power up, the random access memory is checked. A series of bit patterns is written to and read from each address in the RAM. If the read data is different from the written data, the software will display a system fault screen, turn on a continuous two-tone audible alarm, and stop all drug delivery.

Motor Circuit Check

At power up and at regular intervals thereafter, the motor circuit is checked to ensure that no power is being applied to the motor unless the motor is actually on. If the software detects power being applied to the motor at any other time, it will sound a continuous two-tone audible alarm and will no longer attempt to deliver medication. During every pump activation, the software checks to see whether the motor completes one activation. If the motor fails to turn, or fails to complete a cycle, the software will display a system fault screen, turn on a continuous two-tone audible alarm, and stop all drug delivery.

Keyboard Encoder Check

Every time the software receives data from the keyboard encoder, it

is checked. If the data is not a valid key press, the software will disregard the key press. The keyboard is designed with redundant switches for  and . The software must detect that both switches are activated before taking any action.

Data Handling Software Safety Features

Data Stored in RAM

Before use, data associated with delivery and stored in RAM is tested by calculating a CRC on the data and then comparing it with the CRC stored with the data. If the stored and calculated CRCs do not match, the software will display a system fault screen, turn on a continuous two-tone audible alarm, and stop all drug delivery.

Data Stored in EEPROM

Before use, data associated with delivery and stored in EEPROM is tested by calculating a CRC on the data and then comparing it with the CRC stored with the data. If the stored and calculated CRCs do not match, the software will display a system fault screen, turn on a continuous two-tone audible alarm, and stop all drug delivery.

Data Stored in NOVRAM

Before use, data associated with delivery and stored in NOVRAM is tested by calculating a CRC on the data and then comparing it with the CRC stored with the data. If the stored and calculated CRCs do not match, the software will display a system fault screen, turn on a continuous two-tone audible alarm, and stop all drug delivery.

Data Used in Calculations

Calculations on data used in some way to control the delivery of drug are performed redundantly.

The two calculated values are then compared. If the two values do not match, the software will display a system fault screen, turn on a continuous two-tone audible alarm, and stop all drug delivery.

Timer Data Registers

The data in the Real Time Clock is checked at regular intervals. If the data is not reasonable, the software will turn on a continuous two-tone audible alarm and stop all drug delivery.

Annual Functional Inspection and Testing Procedures

Deltec recommends annual functional inspections and tests on all CADD-Legacy™ pumps. The following inspection and testing procedures should be performed annually to verify function and accuracy. The pump must be in Lock Level 0 (LL0) to perform the following inspections and tests.

NOTE: Persons performing the following tests and procedures should be familiar with the CADD-Legacy™ pump. Please read the entire Operator's Manual before proceeding.

CAUTION: CADD-Legacy™ pumps are sealed units. A broken or damaged seal will, therefore, be considered conclusive evidence that the pump has been misused and/or altered, which voids any and all warranties. All service and repair of CADD-Legacy™ pumps must be performed by Deltec or its authorized agents.

Inspection Procedures

Visual Inspection

- Visually inspect the pump for any damage to the LCD, occlusion sensor seals, valves and expulsor, pump hinge area, lock, cassette sensor, keypad, indicator light, power jack, accessory jack, air detector, and housing.
- Check the battery door for proper operation. It should not be broken or damaged. The mating tabs on the pump housing should not be broken or damaged.
- Examine the battery compartment for damage. If the battery

contacts appear corroded, clean them with a cotton swab and isopropyl alcohol (see Cleaning the Battery Contacts). If the battery contacts appear to be bent or pushed in, straightening may be possible with a small screwdriver or other suitable tool. Care must be taken not to damage the pump housing or to incur further damage to the contacts.

Mechanical Inspection

- Press each key on the keypad. Each key should have a distinctive dome feeling. The keys should not feel flat.
- Attach the battery door. The battery door should fit snugly in place when it is closed on the pump.
- Attach either a 50 or 100 ml Medication Cassette™ Reservoir or a CADD® Administration Set to the pump. Using a coin, turn the lock 1/4 turn counterclockwise. Check for smooth operation and a definite “feel” when the lock pulls the cassette firmly against the bottom of the pump. The slot on the lock should be aligned with the arrow on the side of the pump.
- Gently twist and pull on the cassette to make sure it is firmly attached.

Testing Procedures

Functional Testing

Power-up Check



- Insert batteries or press  and observe the LCD during power up. The first screen will display the serial number, model number, and software number with revision level. The second screen will display 32 character blocks. (If “LEC” (Last Error Code) and four digits appear prior to the pump displaying the 32 character blocks, the pump has experienced an electrical or mechanical fault and should be

returned for service.) If no error message is immediately shown, the pump has powered up normally. The pump will then sequentially display all of the programmed values and beep at each screen. After all screens are displayed, successful power up is indicated with six audible beeps and the “STOP” screen displayed. Continue with the lock check.

Lock Check

- Attach a 50 or 100 ml Medication Cassette™ Reservoir or CADD® Administration Set to the pump. The line on the lock should be aligned with the arrow on the side of the pump.

Cassette Sensor Check

- Unlock the cassette by inserting a coin into the lock and turning clockwise.
- The pump will sound a continuous two-tone alarm and the display should show “No Disposable, Clamp Tubing.”
- Press  or  to silence the alarm. Press and hold  to turn the pump off.

The following three checks (LCD, Motor and Gear Train and Reservoir Volume Empty Alarm Check) should be performed in the sequence shown.

LCD Check

- With the pump turned off, press . The second screen that the pump displays will consist of 32 blocks of characters. Examine the LCD to verify that there are no missing dark in the character blocks.

Motor and Gear Train Check

- Program the Reservoir Volume to 2.0 ml.
- Attach a 50 or 100 ml Medication Cassette™ Reservoir or

CADD[®] Administration Set to the pump. Lock the cassette.

- Press and hold **PRIME** until three series of dashes appear. Release **PRIME**. Press and hold **PRIME**. While priming the tubing, listen to the motor for excessive noise or grinding sounds. Count the number of pump activations. The pump should prime ten double activations and then stop. Press **NEXT** to return to the main menu.

Reservoir Volume Empty Alarm Check

- Program the Reservoir Volume to 1.0 ml. Press **NEXT** until Reservoir Volume is displayed on the LCD. Press **▲** or **▼** until 1.0 ml is displayed. Then press **ENTER CLEAR**.
- Press and hold **PRIME** until three series of dashes appear. Release **PRIME**. Press and hold **PRIME**. The pump should prime ten double activations and then stop. The pump will alarm and display “Reservoir Volume Empty.” Press **NEXT**.



Starting/Stopping the Pump

- Program the pump with the following values:
Reservoir Volume: 1.0 ml
Continuous Rate: 3000 ml/24 hr
Given: 0.00 (press **ENTER CLEAR**)
- Program the Air Detector Off (see Section 4, Biomed Functions).
- Press and hold **STOP START**. “Starting” appears followed by three sets of dashes, each accompanied by a beep. A review of the programmed parameters then appears. The main screen should appear with “RUN” in the display.
- To stop the pump, press and hold **STOP START**. “Stopping” appears followed by three sets of dashes that disappear one at a time, each accompanied by a beep. The main screen should appear with “STOPPED” in the display.





Activation Timing Check

- Reprogram the Reservoir Volume to 1.0 ml and clear the Given screen.
- Press and hold  until three dashes disappear from the display. The pump should sequentially display all of the programmed values. Start a timer at the first motor activation.
- Count the activations. One activation should occur every three seconds. Approximately 27 seconds and ten activations later, the Reservoir Volume empty alarm should occur. The display should show “Reservoir Volume empty.”



GIVEN Check

- Stop the pump by pressing and holding . Press  to advance to the Given screen. The display should show 2.00 ml. (If the above steps have not been followed exactly, a different value may appear.)
- Press . The display should now show 0.00 ml.

Air Detector Test

- Turn the Air Detector On (see Section 4, Biomed Functions).
- Reprogram the Reservoir Volume to 10.0 ml. Press  until Reservoir Volume is displayed on the LCD. Press  or  until 10.0 ml is displayed. Then press .
- Attach an empty 50 or 100 ml Medication Cassette™ Reservoir or CADD® Administration Set to the pump. Secure it using the lock button.
- Thread the tubing through the Air Detector groove.
- Start the pump.
- The pump should respond with a continuous two-tone

alarm and the display should read “Air In Line Detected.”

- Press  or  to silence the alarm and remove the empty Medication Cassette™ Reservoir or CADD® Administration Set.
- Now attach a Medication Cassette™ Reservoir containing fluid, or a primed CADD® Administration Set to the pump. Lock the cassette. Make certain that there is no air in the fluid path. Secure it using the lock button.
- Thread the tubing into the Air Detector groove.
- Start the pump. The pump should deliver without activation of the air detection alarm.

Upstream Occlusion Sensor Test

- Verify the Upstream Occlusion Sensor is turned On (see Section 4, Biomed Functions).
- Obtain a CADD® Administration Set with bag spike and anti-siphon valve. Also obtain a clamp (slide clamp or hemostat).
- Insert the CADD® Administration Set spike into an appropriate, standard IV bag filled with water. Attach the cassette to the pump. Prime the entire fluid path.
- Program the pump to deliver a continuous maximum rate. Press and hold  to start the pump.
- Clamp the tubing halfway between the IV bag and the pump. The pump should alarm within three activations after clamping the tubing.

Occlusion Pressure Range Tests

Occlusion Pressure Range Test I

Description

Pressure is generated by activating the pumping mechanism with an attached filled, clamped Medication Cassette™ Reservoir. The pump is started and a fluid is injected until the high pressure alarm sounds.

Equipment needed

50 or 100 ml Medication Cassette™ Reservoir containing distilled water

1-ml syringe

Procedure

1. Insert two AA batteries and wait for the pump to power up.
2. Attach a Medication Cassette™ Reservoir containing water to the pump. Lock the cassette.
3. Prime the Medication Cassette™ Reservoir tubing. The tubing should be filled with fluid to the end of the luer lock connector. The system *must* be free from air bubbles for this test.
4. Withdraw the plunger of the empty 1-ml syringe to the 1.0-ml marking. Now attach the syringe to the end of the Medication Cassette™ Reservoir tubing.
5. Start the pump.
6. When the pump is running, slowly depress the plunger of the syringe, noting when the High Pressure alarm is activated.
7. The pump should alarm when the syringe is between 0.5 and 0.1 ml.

Occlusion Pressure Range Test II

Description

An adjustable metered pressure source is connected to the Medication Cassette™ Reservoir tubing. The pressure is slowly increased until the high pressure alarm sounds.

Equipment needed

Pressure gauge, 40 psi \pm 1 psi [2.76 bar \pm 0.07 bar]

Pressure vessel, partially filled with water

Pressure regulator, 40 psi [2.76 bar]

50 or 100 ml Medication Cassette™ Reservoir containing water

Procedure

1. Insert two AA batteries and wait for the pump to power up.
2. Attach a Medication Cassette™ Reservoir to the pump.

NOTE: The pressure from the source must be zero when the cassette is attached.

3. Assemble the apparatus as shown.

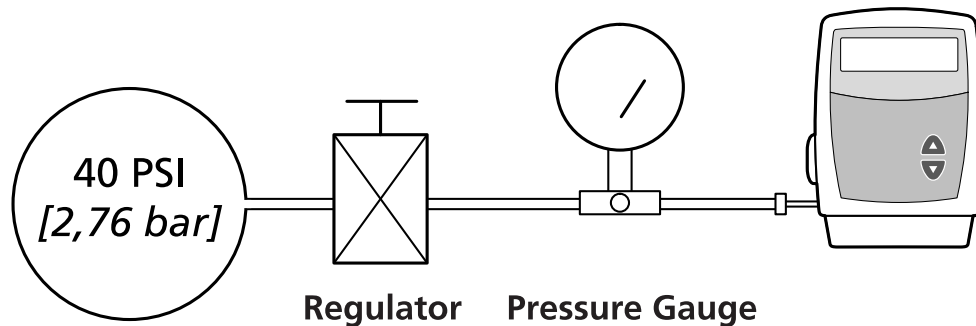

4. Connect the Medication Cassette™ Reservoir outlet tube to the metered pressure source.

NOTE: Do not use a CADD® Extension Set with Anti-Siphon Valve.

5. Start the pump and run at 3000 ml/24 hr.
6. Slowly increase the backpressure, noting when the high pressure alarm is activated.

NOTE: The pressure may be increased rapidly to 8 psi [0.55 bar], after which the pressure should be increased at 3 psi/min [0.21 bar/min] or less until the alarm sounds.

7. The high pressure alarm should sound between 12 and 40 psi (26 ± 14 psi) [*between 0.82 and 2.76 bar (1.79 ± 0.97 bar)*].

CAUTION: At the completion of the test, the pressure must be reduced to zero before detaching the cassette from the pump; otherwise, the cassette may rupture. Safety glasses should be worn while conducting or observing this test.

Accuracy Tests

Gravimetric Accuracy Testing

Description

A Medication Cassette™ Reservoir is partially filled with water and weighed, then attached to a pump that is set to deliver a certain amount of water. The Medication Cassette™ Reservoir is then removed and weighed again. The amount of water delivered is compared to the amount that the pump should have delivered.

Nominal system accuracy is given in the technical specifications section for the pump. That is, under the test conditions described below, the accuracy of the pump and Medication Cassette™ Reservoir will be nominal with a 90% confidence level. The nominal test conditions are as follows: degassed water at $25 \pm 5^\circ\text{C}$ without back pressure.

Equipment needed

- 50 or 100 ml Medication Cassette™ Reservoir
- 50 or 60 ml syringe
- CADD® Extension Set with Anti-Siphon Valve
- A balance accurate to 0.1 g
- 40 ml of room temperature water

Procedure

1. Fill the 50 or 60 ml syringe with 40 ml of water. Transfer the water into a Medication Cassette™ Reservoir.
2. Remove any air from the Medication Cassette™ Reservoir by aspirating the air with the syringe. Attach the CADD® Extension Set with Anti-Siphon Valve. Prime the tubing so it is filled with fluid to the end of the extension set luer lock connector.

3. Secure the slide clamp as close to the extension set luer lock connector as possible. This should assure a minimum water loss from the tubing when the syringe is removed.
4. Weigh the entire Medication Cassette™ Reservoir/extension set assembly and record the weight. This is the predelivery weight. (This weight includes the empty Medication Cassette™ Reservoir, extension set, and weight of the water.)
5. Attach the cassette to the pump. Program the Reservoir Volume to 20 ml. Now press . This value is the **intended delivery volume**. (One ml of water at 20°C weighs 1 gram.) Remove the slide clamp.
6. With the pump in Lock Level 0, set rate to 3000 ml/ 24 hr. Start the pump and wait for the reservoir volume empty alarm. The pump will deliver 20 ml.
7. Again, secure the slide clamp as close as possible to end of the extension set luer lock connector. Remove the cassette from the pump and weigh the entire Medication Cassette™ Reservoir/extension set assembly. This is the **postdelivery weight**.
8. Calculate the difference in weight between the predelivery weight and the postdelivery weight. This is the weight of the amount delivered.
9. Find the difference between the volume of the amount delivered and the intended delivery volume. This is the **inaccuracy volume**.
10. Divide the inaccuracy volume by the intended delivery volume and multiply by 100. This is the **accuracy error percentage**.
11. If the accuracy error percentage is greater than $\pm 6\%$, repeat the test with a new Medication Cassette™ Reservoir. If the pump fails a second time, call SIMS Deltec or SIMS Graseby Ltd.

Example:	Predelivery Weight:	61.1 g
	Postdelivery Weight:	- 41.6 g
	Weight of Amount Delivered:	= 19.5 g
	Volume of Amount Delivered:	19.5 ml
	Intended Delivery Volume:	- 20.0 ml
	Inaccuracy Volume:	= -0.5 ml
	Inaccuracy Volume:	-0.5 ml
	Intended Delivery Volume:	÷ 20.0 ml
	Accuracy Error:	= -0.025
	Accuracy Error:	-0.025
		× 100.00
	Accuracy Error Percentage:	= -2.5%

Volumetric Accuracy Testing

Description

A predetermined amount of water is delivered into a collection device such as a burette or graduated cylinder. The amount of water delivered is compared to the amount that the pump is programmed to deliver.

Nominal system accuracy is given in the technical specifications section for the pump. That is, under the test conditions described below, the accuracy of the pump and Medication Cassette™ Reservoir will be nominal with a 90% confidence level. The nominal test conditions are as follows: degassed water at $25 \pm 5^\circ\text{C}$ without back pressure.

Equipment needed

50 or 100 ml Medication Cassette™ Reservoir

50 or 60 ml syringe

CADD® Extension Set with Anti-Siphon Valve

A fluid collection device such as a burette or a Class A, 25 ml capacity graduated cylinder

40 ml of room temperature water

Procedure

1. Fill the 50 or 60 ml syringe with 40 ml of water. Transfer the water into a Medication Cassette™ Reservoir.
2. Remove any air from the Medication Cassette™ Reservoir by aspirating the air with the syringe. Attach the CADD® Extension Set with Anti-Siphon Valve. Prime the tubing so it is filled with fluid to the end of the extension set luer lock connector.

3. Attach the end of the extension set to the fluid collection device.
4. Attach the cassette to the pump. Program the Reservoir Volume to 20 ml. This is the **intended delivery volume**. Remove all clamps.
5. Program a continuous rate of 3000 ml/24 hrs. Start the pump and wait for the reservoir volume empty alarm.
6. When delivery is complete, record the volume of fluid delivered. This is the **actual delivery volume**.
7. Find the difference between the volume of the amount delivered and the intended delivery volume. This is the **inaccuracy volume**.
8. Divide the inaccuracy volume by the intended delivery volume and multiply by 100. This is the **accuracy error percentage**.
9. If the accuracy error percentage is greater than $\pm 6\%$, repeat the test with a new Medication Cassette™ Reservoir. If the pump fails a second time, call SIMS Deltec or SIMS Graseby Limited.

Example:	Actual Delivery Volume:	19.5 ml
	Intended Delivery Volume:	– 20.0 ml
	Inaccuracy Volume:	= –0.5 ml
	Inaccuracy Volume:	–0.5 ml
	Intended Delivery Volume:	÷ 20.0 ml
	Accuracy Error:	= –0.025
	Accuracy Error:	–0.025
		× 100.00
	Accuracy Error Percentage:	= –2.5%

Index

Bold page numbers indicate figure references

A

AC Adapter, 5, 6, 7
 AC indicator light, 4
 accessory jack, 3, 4
 accuracy, 51
 accuracy tests
 gravimetric, 66
 volumetric, 69
 Administration Set
 Anti-Siphon Valve, 6
 attaching, 24
 cautions, vi
 removing, 23
 warnings, iv
 Air Detector, 4, 6, 16, 28, 36, 50
 inserting tubing into, 28
 status screen, 20, 22
 testing, 61–62
 warning, iv
 alarms, 39, 48
 analgesics, 1
 anesthetics, 1
 caution, vii
 Anti-Siphon Valve, 6
 warning, iv
 arrow keys, 4, 5

B

batteries, AA, 7, 47, 48
 cautions, vi
 warnings, v
 battery compartment, 4, 7
 battery contacts, cleaning, 44

battery, internal clock, 48
 battery life, 48
 Biomed Functions, 35, 50
 Air Detector on/off, 36, 50
 Upstream Sensor on/off, 37, 50
 Biomed Functions Code, 9, 35

C

cassette, 4, 6
 attaching, 24
 cautions, vi
 removing, 23
 warnings, v
 cassette lock, 4, 25
 cleaning pump, accessories, 43–44
 cautions, vi
 Continuous Rate, 10, 20, 21, 31
 programming, 21

D

Downstream Occlusion Sensor, 8

E

ECG equipment, interference
 with, vii, 45
 epidural administration, 1
 warning, iv
 Extension Set
 Anti-Siphon Valve, 6
 warning, iv

G

Given screen, 21
 clearing, 21

Section 5: Reference

I

indicator light, 5
inspection procedures, 57

K

keypad, keys, 4, 5

L

lock, cassette, 7, 25
lock level, 5, 9, 10, 30
Lock Level Code, 9

M

Magnetic Resonance Imaging, 45
 caution, vi
main screen, 8, 33
mounting hole, threaded, 4, 7

P

Polemount Bracket Adapter, 7
power jack, 4, 6
power-up, 16
priming, 26
 warning, vi
programming, 18
programming screens, 19

R

radiation, exposure to, 45
 caution, vi
reservoir, 6, 7, 20, 41, 47
 attaching, 24
 cautions, vi
 removing, 23
 warnings, iv

Reservoir Volume, 8, 10, 20, 21,
 26, 34, 41, 48, 50
 resetting, 34

S

safety features
 hardware, 53
 software, 55
security codes
 Biomed Functions Code, 9, 35
 Lock Level Code, 9
service due, 42
software version, ii, 16
specifications
 Biomed Functions, 50
 general, 47
standards, 46
starting the pump, 33
stopping the pump, 33
subarachnoid administration, 1
 warning, iv
symbols, 3
syringe, warning, iii
system definition, 49

T

turning pump on/off, 34

U

ultrasound, 45
 caution, vi
Upstream occlusion sensor, 7, 37
 status screen, 21
 testing, 62

W

warnings and cautions, iii–vii

Limited Warranty

SIMS Deltec, Inc. (the “Manufacturer”) warrants to the Original Purchaser that the infusion pump (the “Pump”), not including accessories, shall be free from defects in materials and workmanship under normal use, if used in accordance with this Operator’s Manual, for a period of one year from the actual date of sale to the Original Purchaser. THERE ARE NO OTHER WARRANTIES.

This warranty does not cover normal wear and tear and maintenance items, and specifically excludes batteries, administration sets, extension sets or any other accessory items or equipment used with the Pump.

Subject to the conditions of and upon compliance with this Limited Warranty, the Manufacturer will repair or replace at its option without charge (except for a minimal charge for postage and handling) any Pump (not including accessories) which is defective if a claim is made during such one-year period.

The following conditions, procedures, and limitations apply to the Manufacturer’s obligation under this warranty:

A. Parties Covered by this Warranty: This warranty extends only to the Original Purchaser of the Pump. This warranty does not extend to subsequent purchasers. The Original Purchaser may be a patient, medical personnel, a hospital, or institution which purchases the Pump for treatment of patients. The Original Purchaser should retain the invoice or sales receipt as proof as to the actual date of purchase.

B. Warranty Performance Procedure: Notice of the claimed defect must be made in writing or by telephone to the Manufacturer as follows: **SIMS Deltec 1265 Grey Fox Road, St. Paul MN 55112 U.S.A., 1-800-426-2448 or SIMS Graseby Ltd. WD2 4LG UK, +44 (0)1923 246434.** Notice to the Manufacturer must include date of purchase, model and serial number, and a description of the claimed defect in sufficient detail to allow the Manufacturer to determine and facilitate any repairs which may be necessary. **AUTHORIZATION MUST BE OBTAINED PRIOR TO RETURNING THE PUMP.** If authorized, the Pump must be properly and carefully packaged and returned to the Manufacturer, postage prepaid. Any loss or damage during shipment is at the risk of the sender.

C. Conditions of Warranty: The warranty is void if the Pump has been 1) repaired by someone other than the Manufacturer or its authorized agent; 2) altered so that its stability or reliability is affected; 3) misused; or, 4) damaged by negligence or accident. Misuse includes, but is not limited to, use not in compliance with the Operator’s Manual or use with nonapproved accessories. The Pump is a sealed unit, and the fact that the seal has been broken will be considered conclusive evidence that the Pump has been altered or misused. Removal or damage to the Pump’s serial number will invalidate this warranty.

D. Limitations and Exclusions: Repair or replacement of the Pump or any component part thereof is the EXCLUSIVE remedy offered by the Manufacturer. The following exclusions and limitations shall apply:

1. No agent, representative, or employee of the Manufacturer has authority to bind the Manufacturer to any representation or warranty, expressed or implied.
2. THERE IS NO WARRANTY OF MERCHANTABILITY OR FITNESS OR USE OF THE PUMP FOR ANY PARTICULAR PURPOSE.
3. The Pump can only be used under the supervision of medical personnel whose skill and judgment determine the suitability of the Pump for any particular medical treatment.

Section 5: Reference

4. All recommendations, information, and descriptive literature supplied by the Manufacturer or its agents are believed to be accurate and reliable, but do not constitute warranties.

E. Computer Program License:

1. The Pump is intended to be used in conjunction with a particular Licensed Computer Program supplied by Manufacturer and use of any other program or unauthorized modification of a Licensed Computer Program shall void Manufacturer's warranty as set forth above.

2. The Original Purchaser and any users authorized by the Original Purchaser are hereby granted a nonexclusive, nontransferable license to use the Licensed Computer Program only in conjunction with the single Pump supplied by Manufacturer. The Licensed Computer Program is supplied only in machine-readable object code form and is based upon Manufacturer's proprietary confidential information. No rights are granted under this license or otherwise to decompile, produce humanly readable copies of, reverse engineer, modify or create any derivative works based upon the Licensed Computer Program.

3. All other terms and conditions of this Limited Warranty shall apply to the Licensed Computer Program.

The Manufacturer disclaims responsibility for the suitability of the Pump for any particular medical treatment or for any medical complications resulting from the use of the Pump. The Manufacturer shall not be responsible for any incidental damages or consequential damages to property, loss of profits, or loss of use caused by any defect or malfunction of the Pump.

This warranty gives the Original Purchaser specific legal rights, and the Original Purchaser may have other legal rights which may vary from state to state.

Deltec

SIMS Deltec, Inc., St. Paul, MN 55112 U.S.A.



U.S. Distribution:

SIMS Deltec, Inc.
1265 Grey Fox Road
St. Paul, Minnesota 55112 U.S.A.
1-800-426-2448



European Representative:

SIMS Graseby Ltd.
WD2 4LG UK
+44 (0)1923 246434

© 2000 SIMS Deltec, Inc.

All rights reserved.

Printed in U.S.A.

2000-03
40-3935-51D 19875