

# MedSystem III<sup>®</sup> Infusion System with Advanced Dose Rate Calculation and Drug List Editor

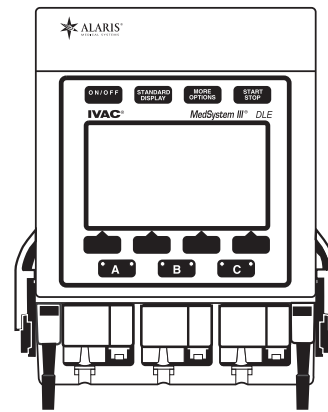

*DIRECTIONS FOR USE*

# TABLE OF CONTENTS

## INTRODUCTION

ABOUT THE PUMP .....	1
FEATURES .....	2
SYSTEM COMPONENTS .....	4
SYMBOLS .....	6

## GETTING STARTED

WARNINGS AND CAUTIONS .....	7
PREPARING THE INFUSION .....	11
PREPARING THE ADMINISTRATION SET .....	11
LOADING THE SET .....	11
FRONT PANEL OVERVIEW .....	12
PROGRAMMING PAGE .....	13
PROGRAMMING PRIMARY FUNCTION .....	16
MAKING CHANGES WHILE INFUSING .....	17
PROGRAMMING OPTION .....	19
KVO STATUS .....	20
SECONDARY MODE .....	21
DOSE RATE CALCULATOR (DRC) USING A SPECIFIC DRUG NAME .....	24
DOSE RATE CALCULATOR PROGRAMMING WITH DRUG? .....	27
DEVICE .....	30
CONFIG .....	32
NOTE .....	33
BATLOG .....	33

## ALARMS, ADVISORIES AND PROMPTS

RESPONDING TO AN ADVISORY, ALARM OR FAULT MESSAGE .....	35
ALARM RESPONSE KEYS .....	35
ADVISORIES .....	36
ALARMS .....	37
FAULT .....	41
WATCHDOG .....	41
OTHER CONDITIONS .....	41

## MAINTENANCE

SPECIFICATIONS .....	43
CHECK-IN .....	45
CLEANING .....	53
INSPECTION REQUIREMENTS .....	56
SERVICE INFORMATION .....	57
WARRANTY .....	59

## GLOSSARY

ABBREVIATIONS, ACRONYMS, UNITS OF MEASURE .....	61
---	----

## GENERAL CONTACT INFORMATION

### Customer Advocacy

For clinical and technical questions, feedback, and troubleshooting assistance.

Phone, toll-free, within the United States and Canada:

(800) 854-7128, Ext. 7812

---

### Technical Support

For technical information related to maintenance procedures and service manual support.

Phone:

Outside the United States: (858) 458-6003

Toll-Free, within the United States : (800) 854-7128, Ext. 6003

Toll-Free, within Canada : (800) 227-7215 (Eastern) OR (800) 667-2335 (Western)

For more detailed information, refer to the "Service Information" section of this document.

---

## About the Pump

The MedSystem III® Drug List Editor Multi-Channel Infusion Pump is intended for use in today's growing professional healthcare environment, including healthcare facilities and home care, for use on adults, pediatrics and neonates.

The MedSystem III® instrument is intended for facilities that utilize infusion pumps for the delivery of fluids, medications, blood and blood products using continuous or intermittent delivery through clinically acceptable routes of administration; such as, intravenous (IV), intra-arterial (IA), subcutaneous, epidural, enteral, or irrigation of fluid spaces.

The MedSystem III® Drug List Editor Multi-Channel Infusion Pump features:

- Three independent fluid delivery systems in the space of one.
- Compact size:
  - reduces bedside clutter
  - simplifies patient transport
- Easy to set up and use, yet provides advanced features.
- Accurate delivery of a variety of fluids.
- Uses administration sets that provide free-flow protection.

Contraindications: None known.

## Features

### Multi-channel Fluid Delivery System

The instrument combines three independent infusion channels in an unparalleled small size.

### Lightweight/portable

The pump with pole clamp weighs just over 5 pounds and is easy to transport.

### Unique, rotating pole clamp

The pump may be attached to a variety of surfaces.

### Dose Rate Calculator (DRC)

The pump calculates a volumetric or dose rate based on values entered for patient weight, drug concentration (drug amount and diluent volume) and dosing parameters.

### Drug List Editor (DLE)

The pump drug list can be customized using Drug List Editor software.

### Six Device Types available

Six available Device Types with configurable parameters (maximum and minimum rates, maximum volumes, baseline and maximum pressures, and air-in-line thresholds) to achieve specific clinical applications:

*General Purpose  
Neonatal  
Controller Pressure*

*Operating Room  
General Purpose II  
Operating Room II*

### Free-flow Protection

The MedSystem III® system Administration Sets contain a cassette that provides protection from free-flow conditions. To remove the cassette from the pump, the cassette's slide clamp is pulled to full extension, occluding the tubing and preventing fluid from flowing.

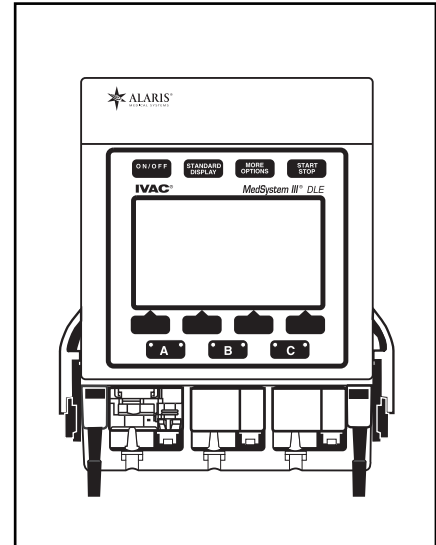

A:	Stopped
<b>DRUG?</b>	Wt ---- KG= 0.0 LB
A:Conc	----- mg/---- ml
A:Dose	----- mcg/kg/min
A:Rate	----- ml/h
A:VR	1 ml (Vol Rem)
A:VI	0 ml DI 0.0 mg
Press Select to choose line	
Select	↑ ↓ Clear

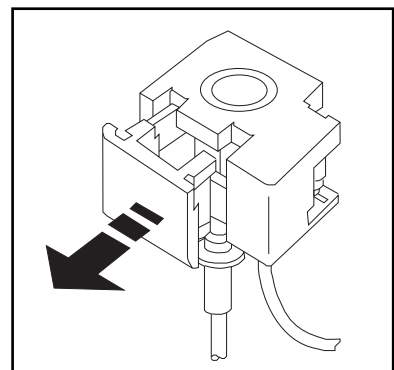

### Monitoring System

The instrument continuously monitors pump conditions and alerts with adjustable audio tones and visual messages.

### Data Monitoring

The pump can be configured to communicate with a remote computer, such as a centralized patient monitoring nurse's station. The COMM receptacle is compatible with RS-232 cabling. A communications manual that describes the programming and hardware involved is available.

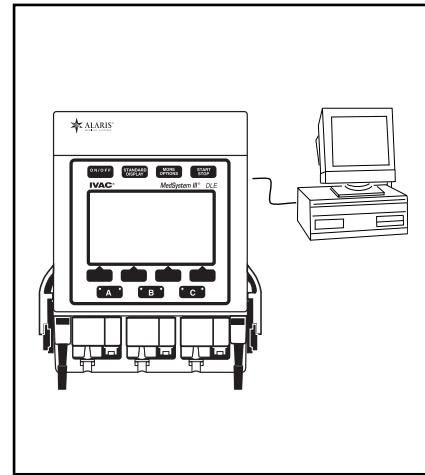

### Field Maintenance Software (FMS)

The pump can be modified to accommodate specialized clinical applications. The Device Type parameters, occlusion limit, and air-in-line threshold can be configured with the FMS software.

### Secondary Mode

Allows the user to program two different rates of infusion to run sequentially.

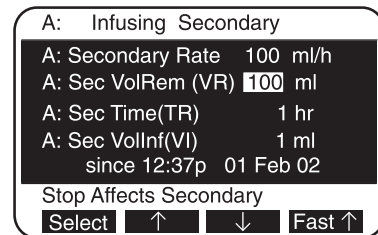

### Syringe Delivery

Accommodates 20cc to 60cc syringe.

### Full Range of Delivery Rates

Rates from 0.1 to 999 milliliters per hour.

### Battery Capacity

A new fully-charged battery provides 6 to 8 hours of operating time with rates at 125 ml/h per channel.

# System Components

## FRONT PANEL

Instrument Keys

Display Screen

Softkey Pads

Channel Indicator Lights

Green:

- Steady - infusing on AC power
- Flashing - infusing on battery power

Red:

- Slow flashing - Advisory
- Rapid flashing - Alert

Channel Select Keys

## CASSETTE

Portion of administration set, inserts into cassette holder.

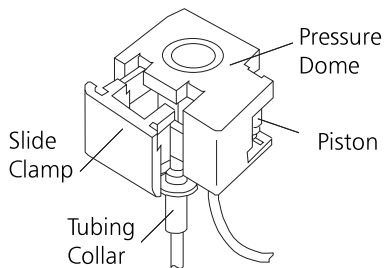

## LOWER ASSEMBLY

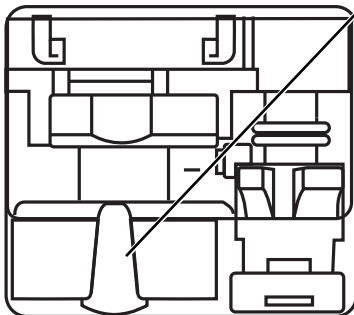

**Air-in-Line Sensor**

Detects bubbles of air during infusion.

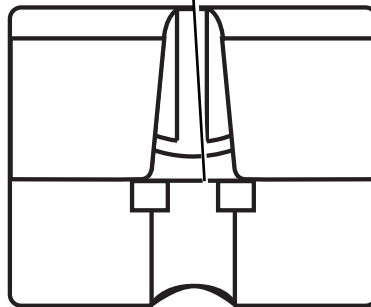

**Tubing Collar Recess**

Holds tubing collar in place.

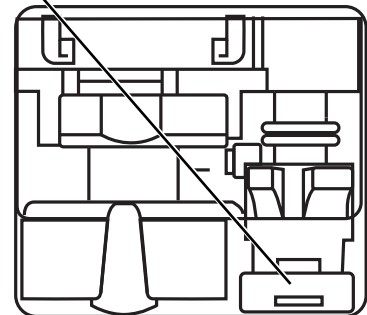

**Pump Latch Mechanism**

Drives the cassette piston to move fluid through the tubing.

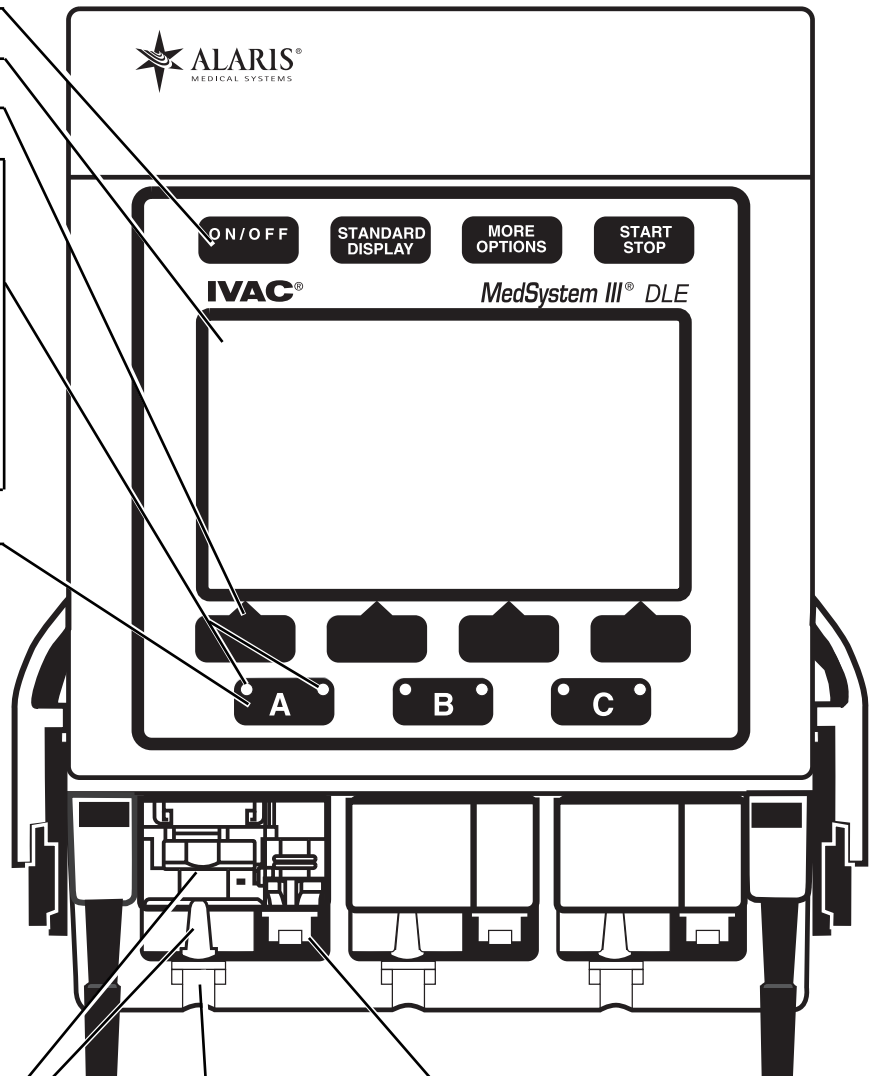

## System Components (Continued)

### CONNECTOR PANEL

**NOTE:** When inserting or removing connectors to the receptacles, avoid excessive force or twisting. To remove AC adapter from pump first remove clip that is on connector.

Remove clip from connector before removing AC adapter from pump.

**External Power**  
External power receptacle connects with power cord.

**Plug Symbol**  
Green light on indicates AC power is connected; batteries are charging.

**COMM**  
Communications line receptacle connects with RS-232.

**Container Hook**  
One hook on each side of the instrument.

**Rotating Latch**  
Allows clamp to spin 360° and position at every 90°.

**Adjustable Pole Clamp**  
Jaw with clutch feature, mounts pump to a pole or bedside.

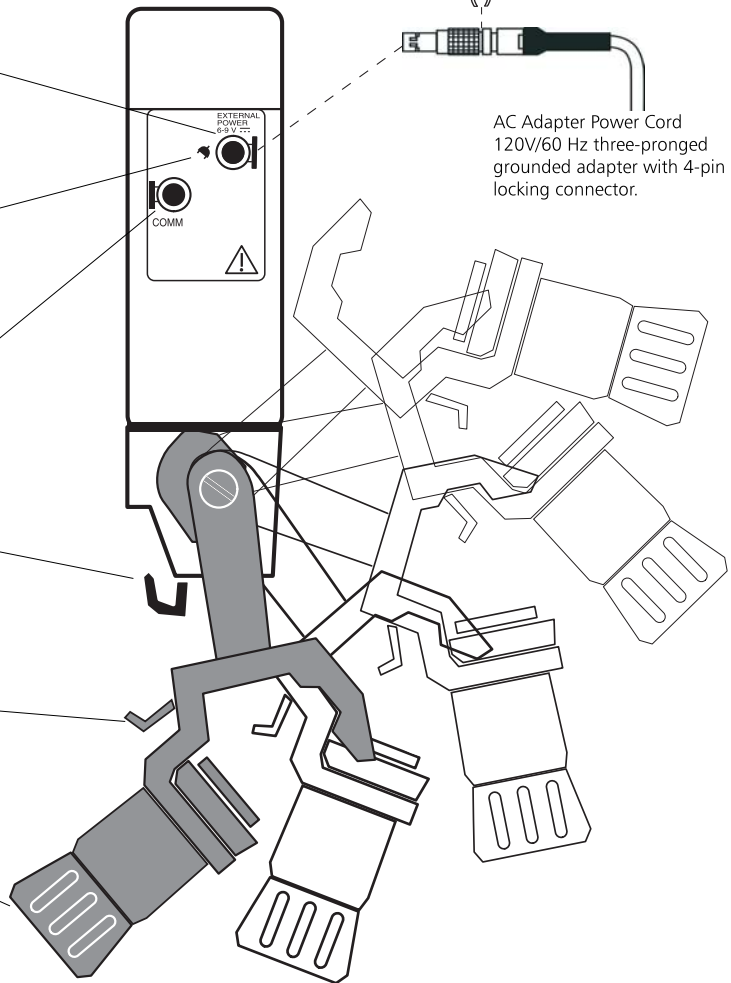

**NOTE:** The MedSystem III® instrument is designed to function in any orientation. However, the effectiveness of the administration set air trap is diminished when the instrument is in other than vertical position.

### Attaching Pole Clamp

To attach the pole clamp, position the clamp jaw over the mounting surface and turn the knob until the clamp is tightened and the pump feels secure. When the knob is as tight as possible, continued turning will make it click and spin freely without over-tightening.

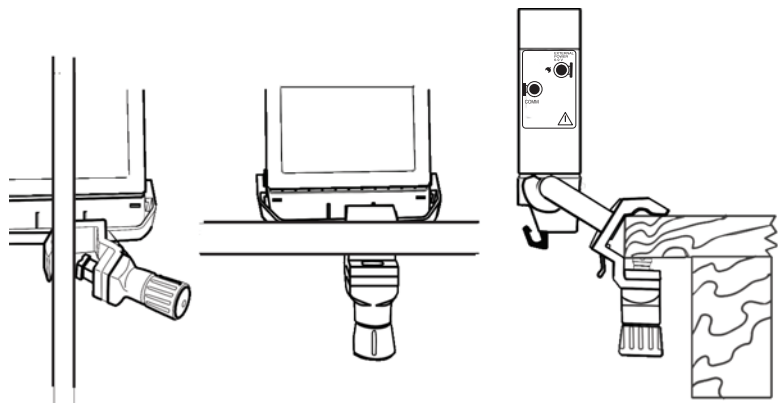



## Symbols



Canadian and U.S. Certification Mark: Products bearing this mark have been tested and certified in accordance with applicable U.S. and Canadian electrical safety and performance standards (CSA C22.2 No. 601.1, UL 2601-1 and IEC 60601–2–24).

**IPX1**

Protection against fluid ingress: Drip Proof.



Attention: Refer to accompanying documentation.



U.S. Certification Mark: Products bearing this mark have been tested and certified in accordance with applicable U.S. electrical safety and performance standards (UL 544).



Manufacturing Date: Number adjacent to symbol indicates the month and year of manufacture.



Consult operating instructions.



Explosion risk if used in presence of flammable anesthetics.

**R<sub>x</sub> Only**

Caution: Federal (U.S.A.) law restricts this device to sale by or on the order of a physician.



Product is Single-Use, Do not reuse.



Product contains DEHP in the fluid pathway.



Product does not contain DEHP in the fluid pathway.



Product is latex-free.



Product incorporates SmartSite® Needle-Free Valve Ports and should not be accessed by a needle.

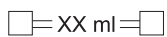

Approximate priming volume.



Drops per milliliter specification for I.V. set will be identified on drop symbol.



Expiration date for I.V. set will be identified near hour glass symbol.

**NOTE:** Although the MedSystem III<sup>®</sup> instrument is built and tested to exacting specifications, it is not intended to replace the supervision of IV infusions by medical personnel. The user should become thoroughly familiar with the features and operation of the MedSystem III<sup>®</sup> instrument and exercise vigilance in its utilization.

Rx Only

## Definitions

### WARNING

This heading alerts the user to potential serious outcomes (death, injury or serious adverse events) to the patient or user.

### CAUTION

This heading alerts the user to take special care for the safe and effective use of the device.

## Warnings and Cautions

To ensure proper performance of the MedSystem III<sup>®</sup> instrument and to reduce potential injury, observe the following precautions:

### Epidural Administration

The MedSystem III<sup>®</sup> instrument can be used for epidural administration of anesthetic and analgesic drugs. This application is only appropriate when using analgesics and anesthetics labeled for continuous epidural administration and catheters intended specifically for epidural use. Use only a MedSystem III<sup>®</sup> instrument 28 Series set, **without** a 'Y' connector or injection port, for epidural infusions.

- Epidural administration of anesthetic drugs: Use indwelling catheters specifically indicated for short term (96 hours or less) anesthetic epidural drug delivery.
- Epidural administration of analgesic drugs: Use indwelling catheters specifically indicated for either short term or long term analgesic epidural drug delivery.

### WARNING

Epidural administration of drugs other than those indicated for epidural use could result in serious injury to the patient.

### WARNING

It is strongly recommended that the infusion pump, source container and MedSystem III<sup>®</sup> Administration Set used for epidural drug delivery be clearly differentiated from those used for other types of administration.

## Warnings and Cautions (Continued)

### WARNING

This instrument is designed to stop fluid flow under alarm conditions other than Low Battery and KVO. Periodic patient monitoring must be performed to ensure the infusion is proceeding as expected.

### WARNING

This infusion device is a positive pressure delivery system, capable of developing positive fluid pressures to overcome widely varying resistances to flow encountered in practice, including resistances to flow imposed by small gauge catheters, filters and intra-arterial infusion. It is neither designed nor intended to detect infiltrations and will not alarm under infiltration conditions.

### WARNING

Hospital personnel must ensure the compatibility of the drugs as well as the performance of each channel as part of the overall infusion. Potential hazards include drug interactions, inaccurate delivery rates, inaccurate pressure alarms and nuisance alarms.

### WARNING

Use only MedSystem III<sup>®</sup> instrument 28 Series administration sets. The use of any other set may cause improper instrument operation, resulting in an inaccurate fluid delivery or other potential hazard.

### WARNING

The use of positive displacement infusion devices ported together with gravity flow infusion systems into a common IV site may impede the flow of common "gravity only" systems, affecting their performance. Hospital personnel must ensure the performance of the common IV site is satisfactory under these circumstances.

### WARNING

References in this document to specific drugs and drug doses are for example only. Refer to specific drug product labeling for information concerning appropriate administration techniques and dosages.

#### Parallel Infusions

There are no contraindications regarding the use of the MedSystem III<sup>®</sup> instrument with any other positive displacement infusion device when ported together into a common IV site location.

## Warnings and Cautions (Continued)

### User Precautions

To ensure proper performance of the MedSystem III<sup>®</sup> instrument and to reduce potential injury to the operator, observe the following precautions:

- Disconnect from mains (AC) and battery power when performing maintenance.
- Do not open the instrument case. There are no user serviceable parts inside. The case should only be opened by qualified service personnel using proper grounding techniques. When the case is opened, an electrical shock hazard exists which can result in serious injury to persons and instrument component damage.



### Administration Sets

- A list of approved IV sets recommended by ALARIS Medical Systems for use with the MedSystem III<sup>®</sup> instrument is listed on the Set Compatibility Card. The use of any other set may cause improper instrument operation, resulting in inaccurate fluid delivery.
- Before operating the instrument, verify that the administration set is free from kinks and installed correctly in the instrument.
- MedSystem III<sup>®</sup> administration sets are disposable, have a sterile fluid path and are intended only for one time use. Do not resterilize.
- Always power on the instrument before inserting the set.
- Do not insert a cassette into a channel with a SERVICE prompt.
- Remove any cassettes from channel(s) requiring service.
- Ensure the cassette is properly installed before starting infusions.
- For set replacement interval, refer to facility protocol and/or government standards (such as CDC guidelines in the United States).
- For IV push medication (put instrument on hold), clamp tubing above the port.
- Flush port(s) per facility protocol.
- Discard administration set per facility protocol.



### Artifacts

It is normal for an infusion device to produce nonhazardous currents when infusing electrolytes. These currents vary proportional to the infusion device flow rate. When the ECG monitoring system is not functioning under optimal conditions, these currents may appear as artifacts, simulating actual ECG readings. To determine if ECG abnormalities are caused by patient condition or the ECG equipment, place the infusion device on hold. If the ECG readings become normal, the ECG equipment requires attention. Proper setup of the ECG equipment should eliminate these artifacts. Reference the appropriate ECG monitoring system documentation for instructions on setup and maintenance.



## Warnings and Cautions (Continued)

### User Cautions (Continued)

#### Dropping/Jarring

Should an instrument be dropped or severely jarred, it should be immediately taken out of use and inspected by qualified service personnel, to ensure its proper function prior to reuse.

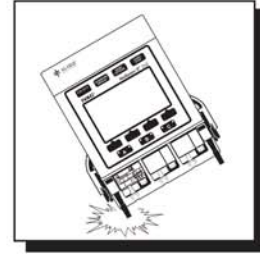

#### Operating Environment

Not for use in the presence of flammable anesthetics.

◀ DANGER ▶

Explosion risk if used in the presence of flammable anesthetics.



#### Radio Frequency Interference

Operating the system near equipment which radiates high energy radio frequencies (electrosurgical/cauterizing equipment, portable radios, cellular telephones, etc.) may cause false alarm conditions. If this happens, reposition the device away from the source of interference or turn off the device and manually regulate the flow with the clamp and/or monitor the vital parameters using an appropriate clinical alternative.

WARNING

Use of accessories or cables other than those specified may result in degraded electromagnetic compatibility performance of this device.

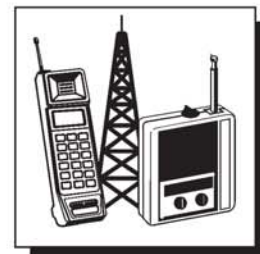

#### Other Precautions

- The AC adapter must be connected to a properly grounded, 3-wire receptacle ("Hospital Use" or "Hospital Grade").
- Avoid excessive force or twisting of detachable power cords when inserting or removing connector terminals.
- Use AC adapter indoors only.
- Do not stack instruments on top of each other.

## Preparing the Infusion

Prepare solution container in accordance with the manufacturer's instructions.

- A syringe can be used as the container for the IV fluid to be infused. Syringe sizes from 20cc to 60cc of such as the B-D and Monoject brands can be used.

**NOTE:** The Model 8631A Syringe Holder is available as an accessory that provides a convenient place to hold syringes while they are being used as containers for IV fluid. The Syringe Holder is designed to be easily installed and removed from the top of the pump and to support up to three syringes. Do not use the Syringe Holder as a handle to carry the pump.

Connect the container to the IV set.

Prime the MedSystem III® instrument administration set in accordance with the Administration Set Directions for Use.

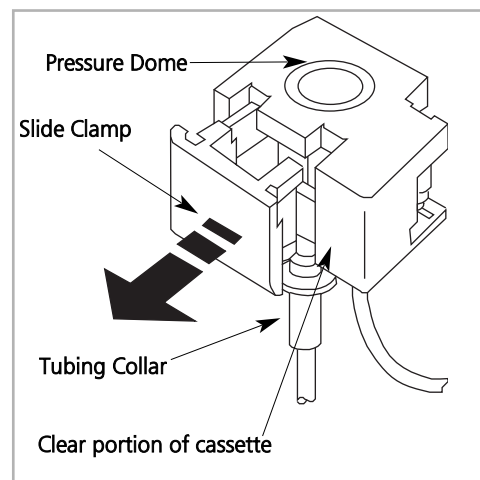

## Preparing the Administration Set

It is important to prime the set properly to eliminate air bubbles.

Ensure the cassette slide clamp is pushed in completely so tubing is not occluded.

Invert the cassette so tubing is up. Slowly open the regulating clamp and establish fluid flow to fully prime the set. Gently tap the cassette and 'Y' sites as necessary to remove all air. Gently massage the pressure dome to ensure no air bubbles are trapped.

### WARNING

An open regulating clamp and slide clamp can cause a free-flow condition and may result in serious injury to the patient.

## Loading the Set

1. Close the regulating clamp before inserting and removing the cassette to reduce the risk of free flow.
2. Ensure cassette slide clamp is pulled out (in the closed position) prior to loading.
3. Press  to turn pump on.
4. With tubing down, use a 45-degree upward motion to insert cassette into channel.
5. Push on clear portion of cassette until completely seated. Then push in slide clamp flush with entire cassette.
6. Pull down gently on tubing collar. Press with thumb to seat tubing collar in recess beneath cassette.

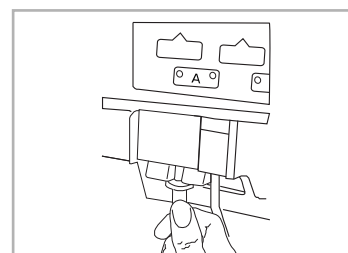
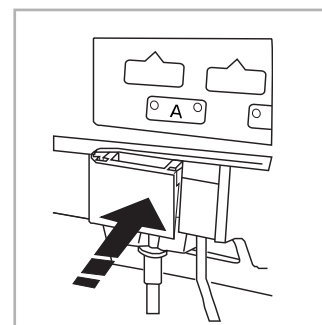

**NOTE:** Three beeps sound when inserted properly.

## Front Panel Overview

### Instrument Control Keys

#### ON/OFF Key

Turns the pump on and off.

#### STANDARD DISPLAY Key

Allows the user to display Standard Display page to view infusion settings for all channels.

#### MORE OPTIONS Key

Allows the user to display additional softkey functions.

#### START/STOP Key

Starts or stops infusion on selected channel.

### Standard Display Page

#### Status Line

Displays infusion status (*Infusing; Stopped; Standby; KVO; ALARM; FAULT; SERVICE*) for each channel.

**NOTE:** Status line in selected channel is highlighted.

#### Infusion Rate

#### Volume Remaining (ml)

#### Volume Infused (ml)

#### Prompt Line

Displays messages that prompt the user to make programming choices and/or take appropriate actions.

#### Softkey Prompts

Displays function of specific softkey.

**STNDBY** Appears in softkey information line when **START STOP** is pressed during infusion.

**Cntrst** (Contrast) Brightens or dims display.

**GP** When pressed, indicates full name of selected Device Type on the prompt line.

**NOTE:** Additional softkey prompts are displayed by pressing **MORE OPTIONS**.

#### Softkey Pads (4)

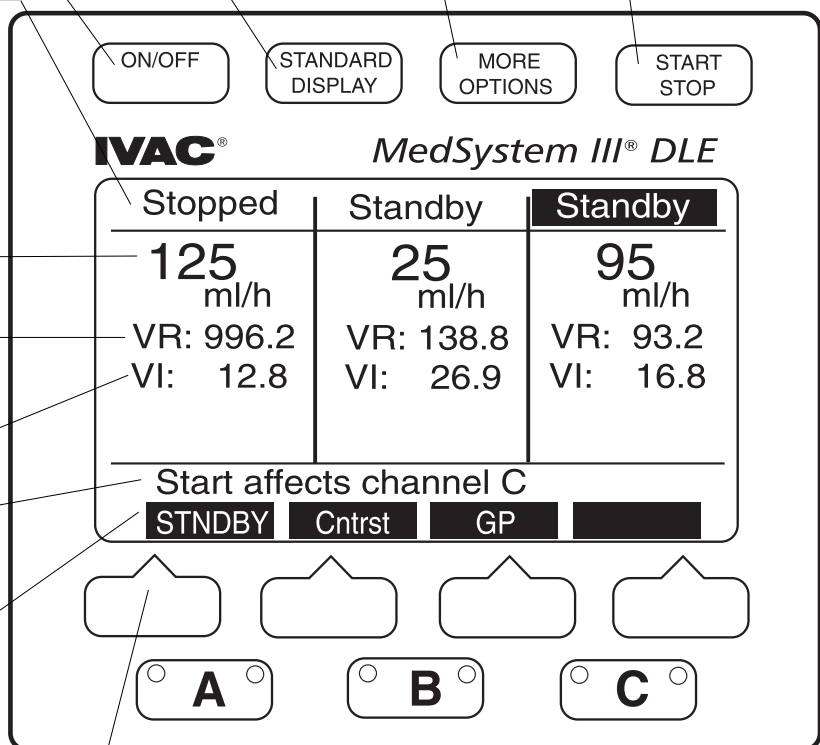

## Programming Page

Selected channel is indicated by the letter displayed at the beginning of the first five lines.

### Status Line

Displays infusion status for selected channel.

### Infusion Rate

### Volume Remaining

### Time Remaining

### Volume Infused

### Date/Time

Displays when volume infused was last cleared and infusion began.

### Prompt Line

Displays messages that prompt the user to make programming choices and/or take appropriate action.

### Softkey Prompts

Displays function of specific softkey.

Select – Moves highlight bar through the programmable infusion parameters.

↑ – Increases highlighted value.

↓ – Decreases highlighted value.

**Fast** ↑ – Increases or decreases highlighted value at greater increments.  
**Fast** ↓

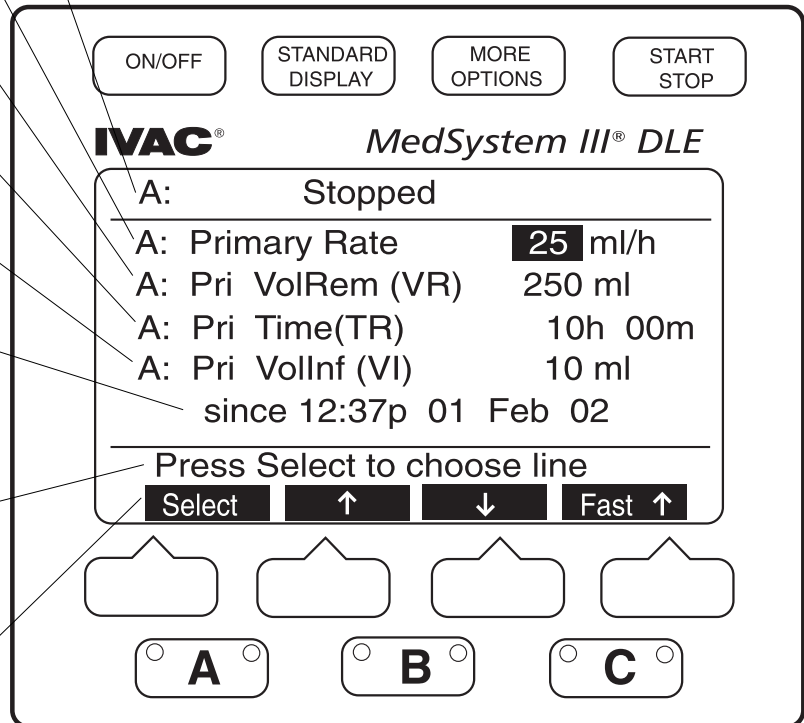



## To turn pump on

Press .

- Upon start-up, the instrument performs an automatic self-test. Listen for a “beep” to ensure that the audio alarm transducer functions properly.
- Instrument Information page is momentarily displayed.
- Continuing to hold down ON/OFF key will keep the Information page on the display.
- When the ON/OFF key is released, the Standard Display page is displayed.

## To turn pump off

Press and hold .

- Display disappears.
- Pump is turned off.



## To view infusion settings for all active channels

Press .

- Standard Display page is displayed.

## To activate additional Standard Display softkey prompts

With the Standard Display page displayed:

1. Press  once.
  - **TotVol**, **Device**, **Config**, and **Note** softkeys appear.
2. Press  again.
  - **Batlog** and **Demold** softkeys appear.

## To select channel and display Programming Pages

Press ,  or .



- Selected channel programming page is displayed.

With programming page displayed:

## To program infusion

1. Press Select to choose value to change.
  - Value is highlighted.
2. Scroll through values using **↑**, **↓**, **Fast ↑** or **Fast ↓**.
  - **↑** and **Fast ↑** increase highlighted values in single or multiple increments.

### To program infusion (continued)

- $\downarrow$  and **Fast**  $\downarrow$  decrease highlighted values in single or multiple increments.
  - Pressing  $\uparrow$  or  $\downarrow$  changes direction of the **Fast**  $\uparrow$  or **Fast**  $\downarrow$ .
  - Highlight remains flashing until **Enter** is pressed. If **Enter** is not pressed, the entry incomplete advisory will sound.
3. Press **Enter** to accept new value.
    - Highlight moves to next programmable value if channel status is **Stopped** or **Standby**.
    - If status is Infusing, highlight remains on selected value.
  4. To recall a previous value after a new value is introduced but not entered, press .
    - Recall soft key appears.
  5. Press **Recall**.
    - Number returns to previous value.
  6. Press .
    - Infusion starts or stops immediately, unless the channel's programming is incomplete, or if an advisory, alarm, or fault condition exists on selected channel.

### To access alarm information

- **ALARM** is displayed in affected channel status line.
- Alarm condition is displayed on the Standard Display of the affected channel.

Press affected channel ,  or .

- Alarm Information page is displayed for that channel.

### To activate additional Programming Page softkeys

With the programming page displayed:

1. Press .
2. Press **2° Sec** to access Secondary page  
OR
3. Press **CalcOn** to access Dose Rate Calculation page.

See the *ALARMS, ADVISORIES AND PROMPTS* section of this manual for more alarm information.

See the *GETTING STARTED* section of this manual for information on the use of the Dose Rate Calculator function.

## Programming Primary Function

### To set primary rate

- Press **A**, **B** or **C**.
  - Programming Page is displayed.
  - Rate is highlighted.
- Press **Select** if current rate is desired
 

OR
- Press **↑**, **↓**, **Fast ↑** or **Fast ↓** to change rate.
  - Value flashes.
- Press **Enter** to confirm.
  - Highlight moves to volume remaining (VR)

A:	Stopped
A: Primary Rate	100 ml/h
A: Pri VolRem (VR)	500 ml
A: Pri Time(TR)	05h 00m
A: Pri VolInf(VI)	1 ml
	since 12:37p 01 Feb 02
Press Select to choose line	
<b>Select</b>	<b>↑</b> <b>↓</b> <b>Fast ↑</b>

### To set primary volume remaining (VR)

- Press **Select** if current VR is desired
 

OR
- Press **↑**, **↓**, **Fast ↑** or **Fast ↓** to change VR.
  - Value flashes.
- Press **Enter** to confirm.
  - Primary time remaining (TR) is calculated automatically based on VR and rate.
  - Highlight moves to volume infused (VI).

A:	Stopped
A: Primary Rate	100 ml/h
A: Pri VolRem (VR)	500 ml
A: Pri Time(TR)	05h 00m
A: Pri VolInf(VI)	1 ml
	since 12:37p 01 Feb 02
Press Select to choose line	
<b>Select</b>	<b>↑</b> <b>↓</b> <b>Fast ↑</b>

### To clear primary volume infused (VI)

- Press **Select** if current VI is desired
 

OR
- Press **Clear** to reset volume infused to zero.
  - Date and time are cleared.
  - Clear** softkey switches to **Recall**.

A:	Stopped
A: Primary Rate	100 ml/h
A: Pri VolRem (VR)	500 ml
A: Pri Time(TR)	05h 00m
A: Pri VolInf(VI)	800 ml
	since 12:37p 01 Feb 02
Press Select to choose line	
<b>Select</b>	<b>Clear</b>

- Press **Enter** to confirm
 

OR
- Press **Recall** softkey to recall previous VI, date and time.
 

THEN
- Open regulating clamp on administration set.
- Press **START STOP** to begin infusion.
  - Channel starts infusing.
  - Current date and time are entered.
- Press **STANDARD DISPLAY**

OR

  - Display reverts to Standard Display page after one minute.
- Verify settings.
- Verify solution flow from primary container.

A:	Stopped
A: Primary Rate	100 ml/h
A: Pri VolRem (VR)	500 ml
A: Pri Time(TR)	05h 00m
A: Pri VolInf(VI)	0 ml
	since -----
Press Enter or Recall	
<b>Enter</b>	<b>Recall</b>

## Making Changes While Infusing

### To titrate or change primary rate during infusion

1. Press **A**, **B** or **C**.
  - Programming Page is displayed.
  - Rate is highlighted.
2. Press **↑**, **↓**, **Fast ↑** or **Fast ↓** to change Rate
  - Value flashes.
3. Press **Enter** to confirm.
  - New rate begins infusing immediately.

### To change volume remaining during infusion

1. Press **A**, **B** or **C**.
  - Programming Page is displayed.
  - Rate is highlighted.
2. Press **Select** to highlight VR.
3. Press **↑**, **↓**, **Fast ↑** or **Fast ↓** to change VR.
  - Value flashes.
4. Press **Enter** to confirm.
  - Infusion continues with new volume remaining

### To clear volume infused during infusion

**NOTE:** When the channel VI is cleared, that volume is not subtracted from the volume on the TotVol page.

1. Press **A**, **B** or **C**.
    - Programming Page is displayed.
    - Rate is highlighted.
  2. Press **Select** to highlight VI.
  3. Press **Clear** then **Enter** to reset volume infused to zero.
    - Date and time are cleared.
    - **Clear** softkey switches to **Recall**.
  4. Press **Enter** to confirm
    - Infusion continues with volume infused reset to zero.
    - Current date and time are entered
- OR**
5. Press **Recall** softkey to recall previous VI value, date and time.

## Making Changes While Infusing (continued)

### To simultaneously clear Total Volume Infused for all channels

1. Press **STANDARD DISPLAY**.
  - Standard Display page is displayed.
2. Press **MORE OPTIONS**.
  - **TotVol**, **Device**, **Config** and **Note** softkeys appear.
3. Press **TotVol** softkey.
  - Total Volume page is displayed
  - VI for each channel and total pump VI values are highlighted.
4. Press **ClrTot** to reset volume infused to zero.
  - Date and time are cleared.

Stopped	Stopped	Stopped
TotVI A	TotVI B	TotVI C
Pri 20	Pri 20	Pri 20
Sec 0	Sec 0	Sec 0
= 20	= 20	= 20
Total VI = 60 ml		
since 03:25p 10 Feb 02		
Press ClrTot to clear TotVI		
ClrTot		

5. Press **Enter** to accept clearing of all values
- OR**
6. Press **Recall** softkey to recall the previous Total VI, date and time.

Stopped	Stopped	Stopped
TotVI A	TotVI B	TotVI C
Pri 0	Pri 0	Pri 0
Sec 0	Sec 0	Sec 0
= 0	= 0	= 0
Total VI = 0 ml		
since ----		
Press Enter or Recall		
Enter	Recall	

### To place a channel on Standby during infusion

***NOTE:** When a channel is Stopped for two minutes with a cassette in place, a Channel Not In Use advisory sounds. When a channel is on Standby, the advisory does not sound.*

***NOTE:** Infusing channel should always be stopped prior to removing cassette.*

1. Press appropriate channel **A**, **B** or **C**.
2. Press **START STOP** to stop infusion.
3. Press **STANDARD DISPLAY**.
  - Standard Display page is displayed.
4. Press **STNDBY**.

Stopped		
100		
ml/h		
VR: 450		
VI: 50		
Start affects channel A		
STNDBY	Cntrst	GP

### To start an infusion from Standby status

1. Press appropriate channel **A**, **B** or **C**.
2. Press **START STOP** to start infusion.

## Programming Option

### To set up an infusion by Rate/Volume or Volume/Time

1. Press **START STOP** if channel is infusing.
2. Press **STANDARD DISPLAY** if Standard Display page not already displayed.
3. Press **MORE OPTIONS**.
  - **TotVol**, **Device**, **Config** and **Note** softkeys appear.
4. Press **Config** softkey.
  - The first of five Instrument Settings pages is displayed.
5. Press **Select** to move the highlight to Setup Line Option.
6. Press **↑** or **↓** to choose Yes.
7. Press **Enter** to enable programming option.
8. Press channel **A**, **B** or **C**.

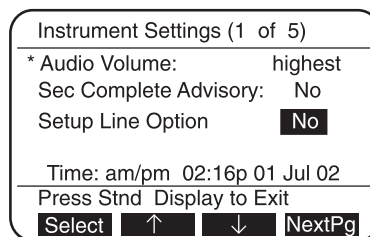

9. Press **Select** to move highlight to
  - Setup: Select VR and Time**
  - OR
  - Setup: Select VR and Rate**
10. If highlighted choice is not desired, press **↑** or **↓** to change setup choice.
  - Choice flashes.

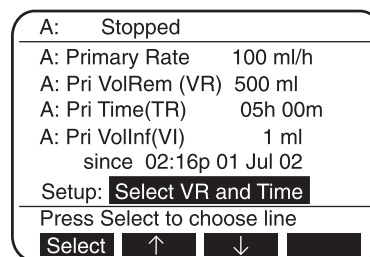

11. Press **Enter** to accept.
  - Highlight moves to top of page.
  - Enter desired settings.

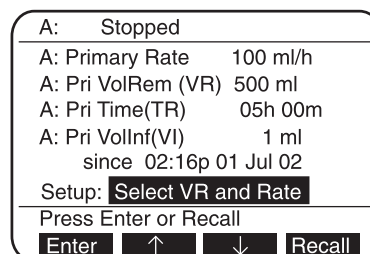

**NOTE:** Rate will highlight but cannot be changed if Volume/Time option is active. Time remaining selection will highlight but cannot be changed if Rate/Volume option is active.

## KVO Status

### To resume infusion when VR=0 (KVO)

With a channel infusing at KVO rate:

- Green light on channel key remains on.
  - Red light on channel key flashes.
  - Two toned advisory sounds.
1. Press appropriate channel **A**, **B** or **C** twice.
    - VR is highlighted.

<b>KVO</b>		
<b>100</b>		
Infusion Complete		
VR = 0		
Alarm Info: Press A		
<b>Centrst</b>	<b>GP</b>	<b>QUIET</b>

2. Press **REPEAT** to recall previous VR  
**OR**
3. Press **↑**, **↓**, **Fast ↑** or **Fast ↓** to change VR.
  - Value flashes.
4. Press **Enter** to confirm.
5. Press **START STOP** to resume infusion and stop KVO rate.

A:	KVO	3.0 ml/h
A: Primary Rate		100 ml/h
A: Pri VolRem (VR)		<b>0</b> ml
A: Pri Time (TR)		----
A: Pri VolInf (VI)		100 ml
		since 12:37p 01 Feb 02
Press Select to choose line		
<b>Select</b>	<b>↑</b>	<b>↓</b> <b>REPEAT</b>

**NOTE:** If current infusion rate is set below KVO rate, channel will infuse at the lower rate.

## Secondary Mode

This option allows two different rates of infusion to be administered sequentially. When secondary volume remaining reaches zero, primary infusion resumes automatically.

To avoid the possibility of concurrent flow during secondary delivery of intermittent medications, set up the administration set as recommended below.

### Preparing the Administration Set and Container

- For Needle-Free sets, attach secondary to upper primary 'Y' site, below a check valve.
- Prepare the secondary IV container according to your institution's policy.
- Suspend secondary solution container at least 8 inches above primary solution container.
- Press **A**, **B** or **C** to select channel.

### WARNING

Setting a secondary rate over 275 ml/h may result in concurrent flow with the primary container.

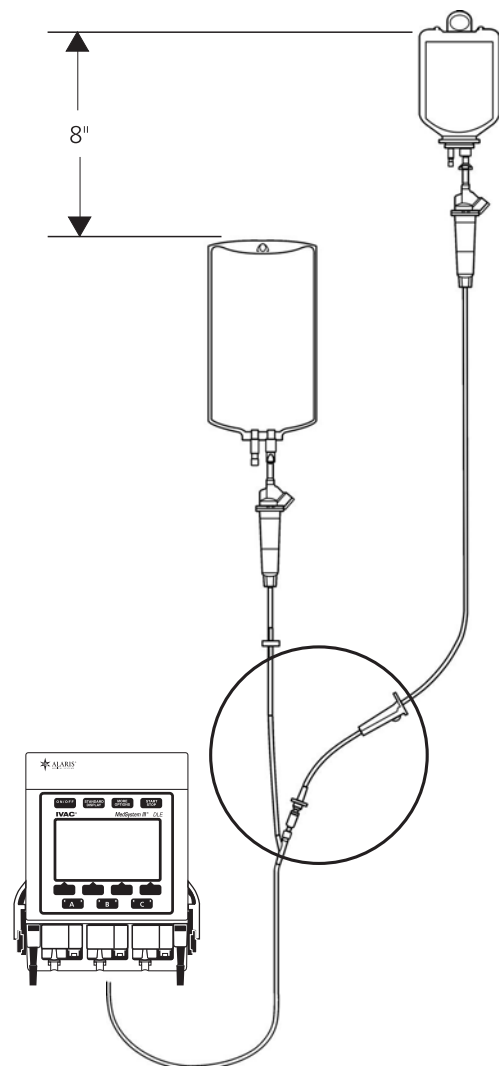



## Secondary Mode (Continued)

### Programming Secondary Infusion

1. Press **A**, **B** or **C**.
  - Primary programming page is displayed.
2. Press **MORE OPTIONS**.
3. Press **2° Sec** softkey.
  - Secondary programming page is displayed.

A: Infusing Primary	
A: Primary Rate	50 ml/h
A: Pri VolRem (VR)	450 ml
A: Pri Time(TR)	09h 00m
A: Pri VolInf(VI)	50 ml
since 12:37p 01 Feb 02	
Press desired function	
<b>2° Sec</b>	<b>CalcOn</b>

**NOTE:** Secondary programming page is reverse highlighted.

### To set secondary volume remaining(VR)

1. Press **Select** to highlight secondary VR, if necessary.
2. Press **REPEAT** to enter the last VR selected  
**OR**
3. Press **↑**, **↓**, **Fast ↑** or **Fast ↓** to change VR.
  - Value flashes.
4. Press **Enter** to confirm.
  - Secondary time remaining (TR) is calculated automatically, based on VR and Rate.
  - Highlight moves to secondary volume infused (VI).

A: Infusing Primary	
A: Secondary Rate	100 ml/h
A: Sec VolRem (VR)	0 ml
A: Sec Time(TR)	----
A: Pri VolInf(VI)	200 ml
since 12:37p 01 Feb 02	
Start Switches to Secondary	
<b>Select</b>	<b>↑</b> <b>↓</b> <b>Repeat</b>

### To clear secondary volume infused(VI)

1. Press **Select** if current VI is desired  
**OR**
2. Press **Clear** to reset volume infused to zero.
  - Date and time are cleared.
  - **Clear** softkey switches to **Recall**.
3. **Enter** to confirm  
**OR**
4. Press **Recall** softkey to recall previous VI value, date and time.

### To set secondary rate

1. Press **Select** if current rate is desired  
**OR**
2. Press **↑**, **↓**, **Fast ↑** or **Fast ↓** to change Rate.
  - Value flashes.
3. Press **Enter** to confirm.  
**THEN**
4. Open regulating clamp on secondary administration set.

## Secondary Mode (Continued)

### To set secondary rate (Continued)

5. Press **START STOP** to begin infusion.
  - Four tones sound (if primary infusion is in progress).
  - Pump starts infusing at secondary rate.
  - Current date and time are entered.
6. Press **STANDARD DISPLAY**

OR

  - Display reverts to Standard Display page after one minute.
7. Verify settings.
8. Verify solution flow from secondary container.

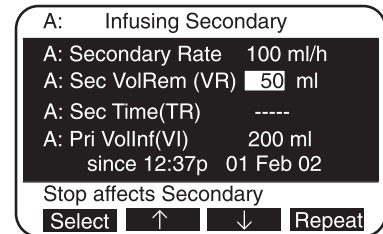

### To set rate of infusion from a time entry

The infusion rate can be set with the volume remaining (VR) and time entry.

1. Press **MORE OPTIONS** from the Standard Display.
2. Press **Config** softkey at bottom of display.
3. Select **Change Instrument Settings** from menu.
4. Press **↑** or **↓**, softkey to change Setup Line Option from **NO** to **YES**.
5. Return to the Standard Display and press a channel.
  - The display will read "Setup: Select VR and Rate".
6. Step down to "Set: Select VR and Rate".
7. Press **Accept** to set a time.

### To titrate or change secondary rate during infusion

**NOTE:** Channel display on the Standard Display is reverse highlighted.

1. Press **A**, **B** or **C**.
  - Secondary programming page is displayed.
  - Rate is highlighted.
2. Press **↑**, **↓**, **Fast ↑** or **Fast ↓** to change rate.
  - Value flashes.
3. Press **Enter** to confirm.
  - New rate begins infusing immediately.

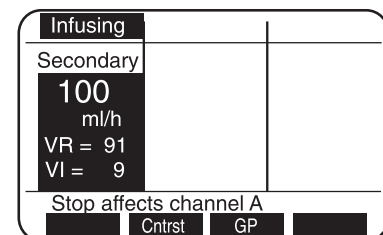

### To review or change primary value(s) during secondary infusion

1. Press **A**, **B** or **C**.
  - Secondary programming page is displayed.
2. Press **MORE OPTIONS**.
  - **1° Pri** and **CalcOn** softkeys appear.
3. Press **1° Pri** softkey.
  - Primary programming page is displayed.

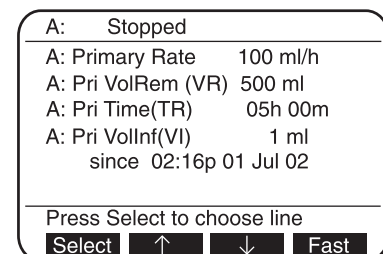

## Secondary Mode (Continued)

### To review or change primary value(s) during secondary infusion (Continued)

4. Press **Select** to highlight value(s) to change.
5. Press **↑**, **↓**, **Fast ↑** or **Fast ↓** to change value(s).
6. Press **Enter** to confirm.

### To start primary infusion before secondary completes

1. Close regulating clamp on secondary infusion set.
2. Press **A**, **B** or **C**.
  - Secondary programming page is displayed.
3. Press **MORE OPTIONS**.
  - **1° Pri** and **CalcOn** softkeys appear.
4. Press **1° Pri** softkey.
  - Primary programming page is displayed.
5. Press **START STOP** to begin primary infusion and stop secondary infusion.
  - Four tones will sound.
  - Infusion starts at primary rate.

### WARNING

Pressing **START STOP** will result in the remaining secondary medication being delivered at the primary rate if the regulating clamp on the secondary set was not closed.

## Dose Rate Calculator (DRC) Programming using a specific drug name

**NOTE:** Dose Rate programming page will not display if channel is infusing. If infusing in secondary mode, switch to primary mode and stop infusion before proceeding.

**NOTE:** Pressing **A**, **B** or **C** at any time during DRC set-up, returns the highlight to the top of the page.

### WARNING

Ensure correct entry of all drug calculation infusion parameters. Consult the drug manufacturer's labeling for information concerning appropriate administration guidelines and dosages.

With this feature, the instrument calculates a volumetric or dose rate based on values entered for patient weight, drug concentration (drug amount and diluent volume) and dosing parameters. If a dose is entered, the volumetric rate is calculated. If a volumetric rate is entered, the dose is calculated.

1. Press **A**, **B** or **C**.
  - Primary programming page is displayed.
2. If infusing, press **START STOP** to stop infusion.
3. Press **MORE OPTIONS**.
  - **2° Sec** and **CalcOn** softkeys appear.
4. Press **CalcOn**.
  - Dose Rate Calculator programming page is displayed.
  - **DRUG?** is highlighted.

A:	Stopped
<b>DRUG?</b>	Wt ---- KG= 0.0 LB
A:Conc	----- mg/---- ml
A:Dose	----- mcg/kg/min
A:Rate	----- ml/h
A:VR	1 ml (Vol Rem)
A:VI	0 ml DI 0.0 mg
Press Select to choose line	
Select	↑ ↓ Clear

## Programming Drug

**NOTE:** Changing drug name clears previous values and changes drug concentration and dose rate parameters to parameters appropriate for the selected drug.

- Scroll using arrow softkeys to display alphabetized, abbreviated drug names.
  - ↓ moves A to Z.
  - ↑ moves Z to A.
  - Fast** ↑ and **Fast** ↓ moves alphabetically through the drug name list. By default, **Fast** goes to the next letter of the alphabet.
- Press **Enter** when desired drug name is highlighted.
  - Highlight moves to **Wt.**

## Programming Weight

- Choose patient's kilogram weight using the ↑, ↓, **Fast** ↑ and **Fast** ↓ softkeys.
- Press **Enter** when desired weight is displayed.
  - Highlight moves to **Conc.**

## Programming Concentration

- Choose concentration using the ↑, ↓, **Fast** ↑ and **Fast** ↓ softkeys.
- Press **Enter** when desired concentration is displayed.
  - Highlight moves to value for diluent volume.
- Choose diluent volume using the arrow softkeys.
- Press **Enter** when desired volume is displayed.
  - VR is automatically set when the diluent volume value is entered but can be changed if desired.
  - Highlight moves to **Dose.**

A: Stopped	
<b>DOPAMINE</b>	Wt 70.0 KG=154.3LB
A:Conc	400 mg/ 250 ml
A:Dose	5.0 mcg/kg/min
A:Rate	13.1 ml/h
A:VR	250 ml (Vol Rem)
A:VI	0 ml DI 0.0 mg
Press Select to choose line	
Select	↑ ↓ Clear

## Programming Dose

**NOTE:** Calculated rates for infusion are fractional and will be displayed as a fraction on the Standard Display even if Device Type is set for whole numbers.

- Choose dose using the ↑, ↓, **Fast** ↑ or **Fast** ↓ softkeys.
- Press **Enter** when desired dose is displayed.
  - Volumetric rate is automatically calculated.
  - Highlight moves to **Rate.**

## Dose Rate Calculator (DRC) Programming using a specific drug name (Continued)

### Changing Volumetric Rate

1. Choose rate value using the  $\uparrow$ ,  $\downarrow$ , **Fast**  $\uparrow$  or **Fast**  $\downarrow$  softkeys if dose rate is not as desired.
2. Press **Enter** when desired volumetric rate is displayed.
  - When rate is changed, dose value is automatically calculated.
  - Highlight moves to VR.

### Changing Volume Remaining

1. Change VR value using the  $\uparrow$ ,  $\downarrow$ , **Fast**  $\uparrow$  or **Fast**  $\downarrow$  softkeys.
2. Press **Enter** when desired VR is displayed.
  - Highlight moves to VI.

### Clearing the Volume Infused(VI) and Dose Infused(DI)

1. Press **Clear** then **Enter** to reset volume infused to zero.
  - Highlight moves to DI.
2. Press **Clear** then **Enter** to reset dose infused to zero.
3. Open regulating clamp.
4. Press **START STOP** to begin infusion.
  - Channel starts infusing.
5. Press **STANDARD DISPLAY**  
OR
  - Display reverts to Standard Display page after one minute.
  - DRC parameters are displayed.
6. Verify settings.
7. Verify solution flow from solution container

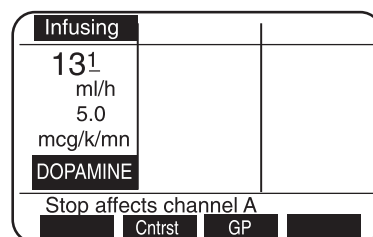

**NOTE:** Stop infusion to make changes to the drug name, weight, or concentration.

### Changing DRC values while infusing

1. Press **A**, **B** or **C**.
  - Dose Rate Calculator programming page is displayed.
  - Dose value is highlighted.
2. Press **Select** to scroll through values that can be changed.
3. When highlight is on value to be changed (*Dose, Rate, VR, VI, DI*), use  $\uparrow$ ,  $\downarrow$ , **Fast**  $\uparrow$  or **Fast**  $\downarrow$  softkeys until desired value is displayed.
  - When dose is changed, rate is automatically recalculated.
  - When rate is changed, dose is automatically recalculated.





## Changing DRC values while infusing (Continued)



- When highlight is on value for VI or DI, **Clear** softkey becomes active. Pressing the **Clear** softkey changes the value to 0.0.
- Press **Enter** after each value change to accept the new value.
  - New rate begins infusing immediately.
- Press  OR
  - Display reverts to Standard Display page after one minute.
- Verify settings.
- Verify solution flow from solution container.

## Dose Rate Calculator Programming with DRUG?

**NOTE:** Dose Rate programming page will not display if channel is infusing. If infusing in secondary mode, switch to primary mode and stop infusion before proceeding.

The **DRUG?** selection can be used to calculate a drug not listed in the pump or for an alternative dosing regimen.

- Press ,  or  .
  - Primary programming page is displayed.
- Press  if channel is infusing.
- Press  .
  - 2\*** **Sec** and **CalcOn** softkeys appear.
- Press **CalcOn**.
  - Dose Rate Calculator programming page is displayed.
  - DRUG?** is highlighted.
- Press **Select**.
  - Highlight moves to **Wt**.

A:	Stopped		
<b>DRUG?</b>	Wt	----	KG= 0.0 LB
A:Conc	-----	mg/----	ml
A:Dose	-----	mcg/kg/min	
A:Rate	-----	ml/h	
A:VR	1	ml (Vol Rem)	
A:VI	0 ml	DI	0.0 mg
Press Select to choose line			
Select			Clear

## Programming Weight

- Choose patient's kilogram weight using **↑**, **↓**, **Fast ↑** and **Fast ↓** softkeys.
- Press **Enter** when desired weight is displayed.
  - Highlight moves to **Conc**.

## Programming Concentration

1. Choose concentration using  $\uparrow$ ,  $\downarrow$ , **Fast**  $\uparrow$  and **Fast**  $\downarrow$  softkeys.
2. Press **Enter** when desired concentration is displayed.
  - Highlight moves to concentration parameters.
3. Choose desired concentration parameters using  $\uparrow$ ,  $\downarrow$ , **Fast**  $\uparrow$  and **Fast**  $\downarrow$  softkeys.
4. Press **Enter** when desired parameter is displayed.
  - Highlight moves to value for diluent volume.
5. Choose diluent volume value using  $\uparrow$ ,  $\downarrow$ , **Fast**  $\uparrow$  and **Fast**  $\downarrow$  softkeys.
6. Press **Enter** when desired volume is displayed.
  - VR is automatically set when the diluent volume is entered, but can be changed if desired.
  - Highlight moves to **Dose** parameters.

### Drug concentration parameters

Gm, mg, mcg, mMol, mEq, mUn, Un

## Programming Dose

1. Choose dose parameters (measure/weight/time) using  $\uparrow$ ,  $\downarrow$ , **Fast**  $\uparrow$  and **Fast**  $\downarrow$  softkeys.
2. Press **Enter** when each desired dose parameter is displayed.
  - Highlight moves to next parameter each time **Enter** is pressed.
  - Highlight moves to **Dose** when **Enter** is pressed to accept time value.
3. Choose dose using  $\uparrow$ ,  $\downarrow$ , **Fast**  $\uparrow$  and **Fast**  $\downarrow$  softkeys.
4. Press **Enter**.
  - Highlight moves to **Rate** parameters.

### Dose parameters

*measure* — Gm, mg, mcg, Ng,  
mMol, mEq, mUn,  
Un  
*weight* — kg  
*time* — min, h, or day



## Changing Volumetric Rate

1. Choose volumetric rate using arrow softkeys if dose calculation is not desired.
2. Press **Enter** when desired rate is displayed.
  - When rate is changed, dose is automatically calculated.
  - Highlight moves to VR.

## Changing Volume Remaining

1. Choose VR value using the arrow softkeys.
2. Press **Enter** when desired VR is displayed.
  - Highlight moves to VI.

## Clearing Volume Infused (VI) or Dose Infused (DI)

1. Press **Clear** then **Enter** to change VI value to 0.
  - Highlight moves to DI.
2. Press **Clear** then **Enter** to change DI value to 0.
3. Open regulating clamp.
4. Press  to begin infusion.
  - Channel starts infusing.
5. Press 





OR



  - Display reverts to Standard Display page after one minute.
  - DRC parameters are displayed.
6. Verify settings.
7. Verify flow.

## Editing Drug List

The Drug List Editor can be used to edit/customize drug list. See Directions For Use for Drug List Editor (DLE).

## Discontinuing DRC option

1. Press ,  or .
  - Dose Rate Calculator programming page is displayed.
2. Press  to stop if infusing.
3. Press .
4. Press **CalcOff**.
  - Display reverts to primary programming page.
  - Volumetric rate, volume remaining and volume infused from DRC are carried over to the primary programming page.

A: Stopped		
DOPAMINE	Wt 70.0	KG=154.3LB
A:Conc	400	mg/ 250 ml
A:Dose	5.0	mcg/kg/min
A:Rate	13.1	ml/h
A:VR	250	ml (Vol Rem)
A:VI	0 ml	DI 0.0 mg
Press Select to choose line		
		 <b>CalcOff</b>

## Facts about DRC

- Drug name, patient weight, or drug concentration cannot be changed while infusing. Changes to patient weight or concentration will recalculate volumetric rate but maintain dose rate.
- Drug names may be abbreviated if the name contains more than eight letters.
- Weight can only be entered in Kg's but is displayed in Kg's **and** Lbs. Weight units can be switched to grams by pressing ↓ to value of 1Kg then repressing ↓. A two tone advisory sounds.
- If dose measurement parameters and concentration measurement parameters are unrelated, a volumetric rate will not calculate. Attempts to start will display a prompt message: **Verify all dose settings**.
- When a drug amount is 10,000 or greater, a **K** is used to replace 000th (i.e. 10,000 = 10K; 12,000 = 12K).
- If a recalculated dose results in a rate outside the rate ranges, a prompt message is displayed: **Rate too High, reenter value or Rate too Low, reenter value**.
- If a recalculated rate results in a dose outside the dose range, the channel will infuse at the entered rate but the dose will display the minimum or maximum allowable limit: (i.e. <0.1 or >999k).
- Secondary option cannot be used when the Dose Rate Calculator is enabled.
- If instrument is off for more than five minutes, the DRC mode will revert to the primary mode.



**NOTE:** The Device Type programming selection affects all three channels. It is not possible to program different Device Types for a channel independently.

There are six Device Types with preset parameters that accommodate specific clinical applications. They are:

<b>General Purpose</b>	<b>Operating Room</b>
<b>Neonatal</b>	<b>General Purpose II</b>
<b>Controller Pressure</b>	<b>Operating Room II</b>

When setting up the pump, select the device type that best suits your clinical needs. The abbreviated name of the Device Type appears as a softkey on the Standard Display page. Pressing the softkey displays the device type in non-abbreviated form on the prompt line.

Maximum rate, maximum volume, pressure and air-in-line threshold are configured at the factory. See **Table 1** for a complete listing of preset parameters. Refer to the **Config** softkey section for programmable and configurable parameters.

These parameters can be modified to meet the institution's specific requirements using FMS software.

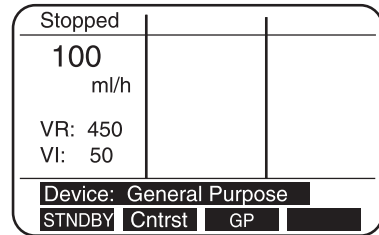

## To change Device Type

1. Press **STANDARD DISPLAY**.
2. Press **MORE OPTIONS**.
  - **TotVol**, **Device**, **Config** and **Note** softkeys appear.
3. Press **Device** softkey.
  - The currently selected Device Type has an asterisk and is highlighted.
4. Press **Select** to move the highlight through the list.
5. Press **Enter** when the desired device is highlighted.

If preset values are compatible with the newly selected device type,

- an asterisk appears next to the device name.

If channel is **not** infusing when device type is changed and preset values are **not** compatible with the newly selected device type,

- The display switches to a notification screen.
- Incompatible Channel(s) indicated.
- Choice is given to continue.

If **Yes**,

- Incompatible values are cleared.
- Display reverts to Standard Display Page.
- New Device Type becomes active.

If **No**,

- Display reverts to Change Device Type page.

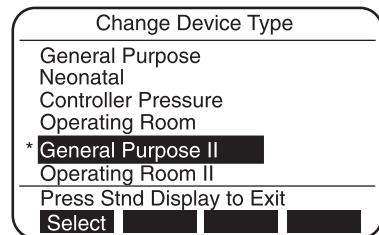
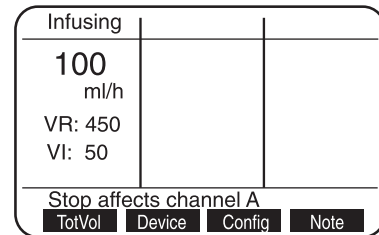

## To change Device Type (Continued)

If channel is infusing when device type is changed and preset values are **not** compatible with the newly selected device type,

- The display switches to the notification screen.
- Incompatible Channel(s) is indicated.
- Choice is given to continue.

If **No**,

- Display reverts to Change Device Type page for user to select another device type.

If **Yes**,

- The pump will alarm.
- Infusion will stop on affected channel(s).
- Display reverts to Standard Display with Alarm indicated in affected channel.

6. Press affected channel  **A** ,  **B** or  **C** .
7. Follow instructions displayed.

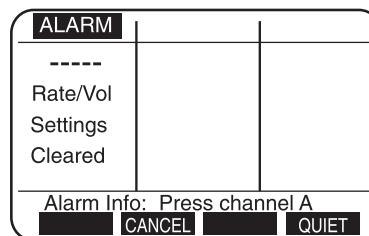

**Table 1**

Default Parameter	General Purpose	Neonatal	Controller Pressure	Operating Room	General Purpose II	Operating Room II
Occlusion Detection Method	Baseline	Baseline	Absolute Threshold	Baseline	Baseline	Baseline
Occlusion Alarm Setting	Baseline +5 psi	Baseline +3 psi	3 ft H <sub>2</sub> O	Baseline +5 psi	Baseline +5 psi	Baseline +5 psi
Maximum Pressure	15 psi	15 psi	3 ft H <sub>2</sub> O	15 psi	15 psi	15 psi
Air-in-line Alarm Threshold	500 μl	50 μl	500 μl	500 μl	500 μl	500 μl
KVO Rate*	3 ml/h	1.0 ml/h	3 ml/h	3 ml/h	3.0 ml/h	3.0 ml/h
Rate Range	1 —999 ml/h	0.1 —99.9 ml/h	1 — 299 ml/h	1 —999 ml/h	0.1—999 ml/h	0.1—999 ml/h
Maximum VR Setting	9999 ml	9999 ml	9999 ml	9999 ml	9999 ml	9999 ml
Pump Not In Use Advisory	Yes	Yes	Yes	No	Yes	No
ALL Setting for VR	N/A	N/A	N/A	Option	N/A	Option



\* Channel will infuse at the KVO rate shown in table or at the current infusion rate, whichever is lower.

**NOTE:** Values shown in table can be modified to meet the institution's requirements using FMS software. To review actual default parameters on a MedSystem III® DLE instrument. Select a Device Type and refer to Instrument Settings pages 2 through 5. An asterisk appears beside settings which are not factory default.

## Config (Configuration)

The Config option allows the user to view and/or change some instrument settings. There are five pages in this option. Items shown on page 1 of the **Config** option can be changed by the user (see Table 2). Pages 2 - 5 of the **Config** option can only be changed by qualified personnel using FMS software.

### To access Instrument Settings information

1. Press .
  2. Press .
    - **TotVol**, **Device**, **Config** and **Note** softkeys appear.
  3. Press **Config** softkey.
    - The first of five Instrument Settings pages is displayed.
    - An asterisk indicates options that have been changed from factory settings.
  4. Pressing **Select** moves the highlight through the list.
  5. Press **↑** and **↓** to change a highlighted setting.
    - **Select** softkey changes to **Enter** and **NextPg** softkey changes to **Recall** when a setting is changed.
  6. Press **Enter** to accept new setting
- OR
7. Press **Recall** to recall previous setting.
  8. Press  to exit Instrument Settings page.

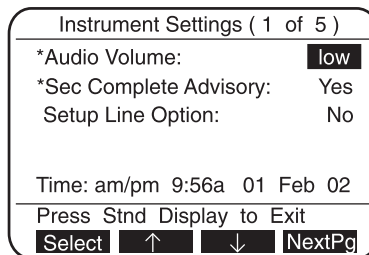
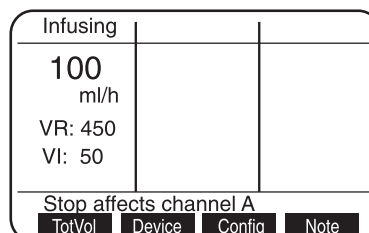

**Table 2**

Option	Choices	Description
Audio Volume	low medium high highest	A tone accompanies each level to aid in determining volume choice. If an alarm is ignored, the volume will ramp to the highest audio unless disabled by FMS. Factory default is "highest."
Sec Complete Advisory	Yes No	Pump sounds two tones and displays advisory when secondary VR = 0. Factory default is "No."
Setup Line Option	No Yes	Enables infusion to be set up as rate/volume or volume/time. Stop infusion before modifying this line option. Factory default is "No."
Time	24 hr am/pm	Allows pump to be set with a 12 or 24 hour clock. Factory default is "am/pm."
Hour/minutes	0000-2359	} Each item can be adjusted when highlighted.
Day	1-31	
Month	Jan-Dec	
Years	00-99	

## Note

The Note soft key accesses the Special Note Message page. When a note is programmed, it appears when the pump is turned on.

### To access Note(s)

1. Press **STANDARD DISPLAY**.
2. Press **MORE OPTIONS**.
  - **TotVol**, **Device**, **Config** and **Note** softkeys appear.
3. Press **Note** softkey.
  - Note information is displayed.
  - If no information has been programmed on the note page, there will be a two tone advisory and the message **There is no Special Note** will display on the prompt line.

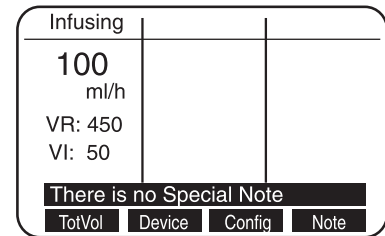
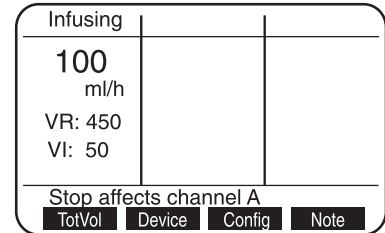

## BatLog (Battery History Log)

The BatLog softkey accesses the Battery History Log page. This page is provided for the Biomedical Engineering staff to review and record battery history data.

### To access Battery History Log

1. Press **STANDARD DISPLAY**.
  2. Press **MORE OPTIONS** twice.
    - **BatLog** and **DemoWD** softkeys appear.
  3. Press **BatLog** softkey.
    - The Battery History page is displayed.
  4. Press **STANDARD DISPLAY** to exit Battery History page
- OR
- Display switches to Standard Display page after 1 minute.

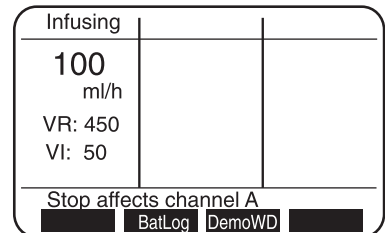

THIS PAGE  
INTENTIONALLY  
LEFT BLANK

# ALARMS, ADVISORIES AND PROMPTS

Use this troubleshooting information in conjunction with appropriate hospital procedures.

## Responding to an advisory, alarm, or fault message

1. Press **QUIET**.
  - Audio tone stops.
  - Red light flashes on affected channel.
2. Press affected channel **A**, **B** or **C**.
  - Alarm Information page is displayed.
3. Take appropriate action(s) indicated on the display.
4. Press **START STOP** to resume infusion.
  - Channel starts infusing.
5. Press **STANDARD DISPLAY**

**OR**

  - Display reverts to Standard Display after one minute.
6. Verify settings.
7. Verify flow.

## Alarm Response Keys

**NOTE:** Channel's VR and VI values are updated with each press of ClrAir softkey.

**NOTE:** A  appears on Standard Display page to indicate CONFIRM has been pressed

**QUIET** silences Advisories, Alarms, and Faults for two minutes. Softkey is accessible during alarm status.

**CANCEL** clears alarm and advisory messages and stops tone. Use when alarm or advisory condition cannot be corrected or user chooses not to correct.

**ClrAir** moves air bubbles past air-in-line sensor. Each press of the ClrAir softkey displaces approximately 0.2 ml of air/fluid. Three beeps indicate when air bubble is no longer in front of the air-in-line sensor.



**CONFIRM** is present during **Check Fluid Side** alarms. Allows infusion to continue if no upstream occlusion is found.

**RETRY** resets resumable fault conditions. Used when attempting to re-establish normal operation of a channel.

**SERVICE** disables use of affected channel. Once pressed, servicing of the pump is required before channel can be used.

## Advisories

*Two beeps, slow flashing red light on infusing channel's channel key; infusion continues.*

Alarm	Meaning	Response
Check Air Sensor	<p>At installation of cassette:</p> <p>a) air is detected in tubing;</p> <p>b) tubing collar is not properly seated;</p> <p style="text-align: center;">or</p> <p>c) air sensor is dirty or damaged.</p>	<p>Verify tubing collar is fully seated in air sensor recess.</p> <p>Verify tubing in air sensor recess is not damaged, twisted or dirty.</p> <p>Press <b>ClrAir</b> on channel's Alarm Information page. Three beeps indicate air bubble is no longer in front of air sensor.</p> <p>If air is still present, remove cassette and manually clear air according to hospital policy.</p> <p>If no air is present, clean air sensor recess as directed in cleaning instructions.</p>
Infusion Complete VR = 0	<p>VR has counted down to zero. Channel is infusing at KVO rate.</p>	<p>Enter new VR or, if same volume is desired, press <b>REPEAT</b>.</p> <p>Press <b>Enter</b>.</p> <p>Press  to resume primary infusion rate.</p> <p>Verify fluid flow.</p>
Low Battery	<p>30 minutes or less battery power remaining.</p>	<p>Connect AC adapter power cord to pump.</p> <p>Plug into wall outlet.</p>
Channel Not In Use	<p>Two minutes have elapsed since cassette was installed or infusion was stopped.</p>	<p>Press <b>STANDBY</b> to place channel on Standby,</p> <p style="text-align: center;"><b>OR</b></p> <p>Press  to start infusion,</p> <p style="text-align: center;"><b>OR</b></p> <p>Remove cassette.</p>



## Alarms

*Four rapid-beeps, infusion stops, rapidly flashing red light on channel key.*

Alarm	Meaning	Response
Air In Line	Air detected in fluid pathway during infusion, or air sensor is dirty.	<p>Verify tubing collar is fully seated in air sensor recess.</p> <p>Verify tubing in air sensor recess is not damaged, twisted or dirty.</p> <p>Press <b>ClrAir</b> softkey on channel's Alarm Information page. Three beeps indicate air bubble is no longer in front of air sensor.</p> <div style="border: 1px solid black; padding: 5px; margin-top: 10px;"> <p><b>NOTE:</b> Each press of the ClrAir softkey displaces approximately 0.2 ml of air/fluid and updates channel's VR and VI values.</p> </div> <p>If air is still present, remove cassette and manually clear air according to hospital policy.</p> <p>If no significant air is present, clean air sensor recess as directed in cleaning instructions.</p> <p>Set up pump at or slightly below IV site to minimize formation of micro bubbles.</p> <p>Press  to resume infusion.</p>
Air In Lower Tubing	<p>Air bubbles detected in fluid pathway with a total volume exceeding the air- in-line threshold setting.</p> <p>Possible outgassing and/or leaks in administration set.</p>	<p>Check administration set for leaks.</p> <p>Check lower tubing for multiple small air bubbles.</p> <p>Press <b>ClrAir</b> softkey on channel's Alarm Information page. Three beeps indicate air bubble is no longer in front of air sensor.</p> <div style="border: 1px solid black; padding: 5px; margin-top: 10px;"> <p><b>NOTE:</b> Each press of the ClrAir softkey displaces approximately 0.2 ml of air/fluid and updates channel's VR and VI values.</p> </div> <p>If air is present, clear air according to hospital policy.</p>





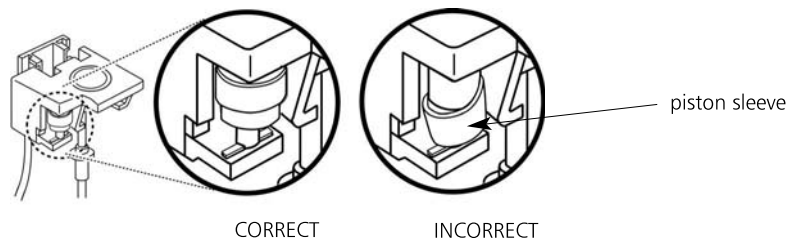

## Alarms (Continued)





Alarm	Meaning	Response
Air In Line Tubing (continued)		<p>(Continued)</p> <p>Set up pump at or slightly below IV site to minimize formation of micro bubbles.</p> <p>If no significant air is present, press  to resume infusion.</p>
Battery Depleted	Insufficient battery power. The pump will shut down in 5 minutes.	<p>Connect AC adapter power cord to pump and plug into wall outlet.</p> <p>Press  to resume infusion(s).</p> <div style="border: 1px solid black; padding: 5px; margin-top: 10px;"> <p><b>NOTE:</b> Drug List is lost if pump battery is totally depleted. Drug List can be reloaded into the pump with FMS software only.</p> </div>
Cassette Jammed	Cassette piston is difficult to move or piston sleeve is loose.	<p>Remove cassette, check placement of soft, plastic piston sleeve and reposition, if necessary.</p> <p>If condition continues, try cassette in a different channel.</p> <p>Replace administration set if alarm recurs or if piston does not move freely.</p> <p>If alarm recurs with several cassettes, channel may need service.</p>



## Alarms (Continued)

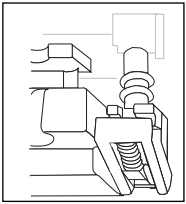
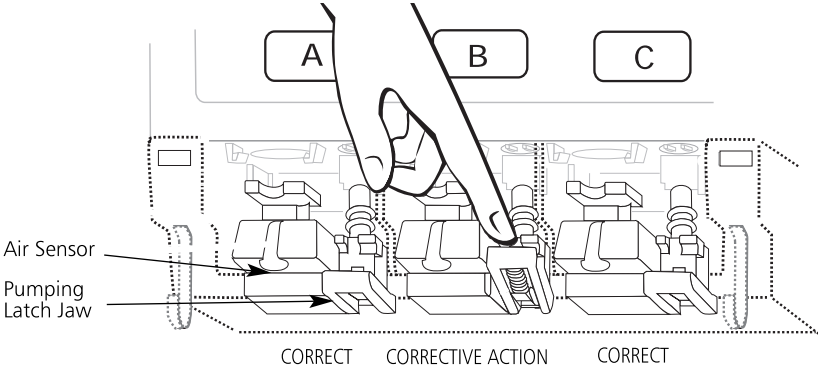

Alarm	Meaning	Response
Cassette Not Latched	Cassette is partially disengaged or latching mechanism is dirty.	<p>Push cassette completely in. Ensure slide clamp is flush with entire cassette. Press  to resume infusion.</p> <p>If condition continues, try cassette in a different channel. Replace administration set if alarm recurs.</p> <p>Clean lower assembly according to cleaning instruction described in MAINTENANCE section of this document.</p>
Cassette Removed	Cassette is removed from holder while channel is infusing.	<p>Reinstall cassette, and press  to resume infusion</p> <p style="text-align: center;"><b>OR</b></p> <p>Press Cancel.</p>
Check Fluid Side	Possible upstream restrictions to flow.	<p>Check tubing between container and pump for a closed regulating clamp, closed vent (with unvented container), kinked tubing, empty syringe, or any restriction to flow.</p> <p>If NO occlusion is present, press CONFIRM.</p> <p>Press  to resume infusion.</p> <p>Verify fluid is flowing in drip chamber.</p> <p>A  appears on standard display to indicate Confirm has been pressed.</p>
Faulty Cassette	Cassette may be damaged or inoperable. Possible malfunction of cassette sensor located in holder.	<p>Reinsert cassette in another channel.</p> <p>If alarm recurs in second channel, replace administration set.</p> <p>If alarm recurs with two cassettes in the same channel, discontinue use and contact qualified service personnel.</p>

## Alarms (Continued)

Alarm	Meaning	Response
Fluid-Side Occluded	Upstream restriction to flow.	<p>Check tubing between container and pump for a closed regulating clamp, closed vent (with unvented container), kinked tubing, empty syringe, or any restriction to flow.</p> <p>Clear occlusion.</p> <p>Press  to resume infusion.</p> <p>Verify fluid is flowing in drip chamber.</p>
Patient-Side Occluded	Downstream restriction to flow.	<p>Check tubing between pump and patient for kinks, closed clamps, closed stopcocks, clogged filters, site problems, etc.</p> <p>Clear occlusion or change infusion site.</p> <p>Press  to resume infusion.</p> <p>Verify fluid is flowing in drip chamber.</p>
Pumping Latch Closed	Pumping latch jaw located to right of air sensor is closed or broken.	<p>Using only your finger, push down pumping latch jaw until it snaps open.</p> <p>If pumping latch jaw is visibly broken, contact qualified service personnel.</p>
<div style="text-align: center;">  <p>INCORRECT</p> </div>	<div style="text-align: center;">  <p>Air Sensor</p> <p>Pumping Latch Jaw</p> <p>CORRECT    CORRECTIVE ACTION    CORRECT</p> </div>	
Rate/Vol Settings Cleared	Rates and/or volumes are incompatible with newly selected Device Type.	<p>Re-enter settings as required.</p> <p>Press  to resume infusion.</p>

## Fault

*Numeric message, European siren, rapid-flashing red light, infusion stops.*



Alarm	Meaning	Response
Channel Out of Order	Safety checks built into software have detected a faulty channel.	CORRECTIVE ACTION for resumable faults only.
Fault Number	Safety checks built into software have detected a fault condition.	Press affected channel  ,  or  Follow instructions on channel's Alarm Information page. Press <b>RETRY</b> to clear fault. If fault recurs, press <b>SERVICE</b> and contact qualified service personnel.

## Watchdog

*Blank screen, continuous tone red and green lights continuous, all infusions stop.*

Blank Screen	Safety checks built into software have detected an instrument error condition.	Attempt to reset pump: Turn pump off, then on again. Press  to resume each channel that had been infusing. If Watchdog alarm recurs or pump cannot be turned on, replace pump and notify qualified service personnel.
--------------	--	--

## Other Conditions

Screen is too light or dark to read with pump on.	Press  . Press <b>Contrst</b> softkey to change screen contrast.
Pump Shut Off: Low Power. Pump shut down after a Battery Depleted alarm had not been corrected.	Connect AC adapter cord to pump and plug into wall outlet.  next to External Power receptacle is lit green when AC power is properly applied.

THIS PAGE  
INTENTIONALLY  
LEFT BLANK

## Specifications

STANDARDS	UL 544, CSA C22.2, No. 125
CASE MATERIAL	Impact resistant polycarbonate/ABS alloy
DIMENSIONS	Height 7.875 inches (20.00 centimeters) Width 6 inches (15.24 centimeters) Depth 2.10 inches (5.33 centimeters)
WEIGHT	Approximately 5.1 pounds (2.3 kilograms) including pole clamp
AIR-IN-LINE (DEFAULT)	500 $\mu$ l (except for Neonatal device type which is 50 $\mu$ l)
OCCLUSION PRESSURE (DEFAULT)	15 psi except for Controller Pressure device type which is 3 ft H <sub>2</sub> O
OPERATING TEMPERATURE	50-104° Fahrenheit (10° - 40° Celsius)
TRANSPORT/STORAGE TEMPERATURE	-4 to +131° Fahrenheit (-20 to + 55°C) (<95°F or 35°C for optimum battery life)
RATE RANGE	0.1 - 999 milliliter per hour (each channel)
VOLUME RANGE	0.1 - 9999 milliliter (each channel)
KVO RATE RANGE	0.1 - 20.0 milliliter per hour
RATE ACCURACY:	1.0 - 999 ml/hr $\pm$ 5% with a standard deviation of 1.96 under specified conditions.*  0.1 - 0.9 ml/hr $\pm$ 10% with a standard deviation of 1.96.
ADMINISTRATION SETS	Use only MedSystem III® Administration Sets
POWER CONSUMPTION	6 watts AC power. Use only MedSystem III® AC Adapter, Model 1555, or 1560A, ordered as 2861089.
BATTERIES	Main – Rechargeable NiCd Battery Pack Memory Back-up – Nonrechargeable Lithium
	<b>NOTE:</b> Use only approved Alaris Medical System® Battery Packs.
BATTERY CHARGE	A fully charged battery has a minimum of 6 hours running time with all channels running at 125 milliliters per hour and backlight usage of 2 minutes per hour.  The main battery retains 80% of its capacity after 500 charging cycles, and retains 90% of its capacity after 3 months of continuous AC charging.
	<b>NOTE:</b> Replacement of both the main and memory backup batteries must be performed by qualified service technicians.
AC ADAPTER & CORD LENGTH	Model 1555, 7.5 Vdc @ 1 Amp with 10 ft cord. Model 1560A, 7.5 Vdc @ 1.65 Amp with 10.5 ft. cord.
AC POWER REQUIREMENTS	Voltage 90 VAC to 132 VAC Frequency 47 Hz to 63 Hz

## Specifications (Continued)

FUSES	3 amp fast-blow internal
GROUND CONTINUITY	Maximum 0.1 ohm
LEAKAGE CURRENT	Maximum 100 microamps

\* *Long-term accuracy specified, per IEC 60601-2-24, under the following conditions:*

Head height:	<i>30"</i>
Test solution:	<i>Distilled water</i>
Environmental:	<i>Ambient temperature</i>
Back pressure:	<i>18 gauge needle</i>
IV set:	<i>Model 28034</i>

## Check-In

This is a Quick Reference Procedure for check-in and configuration of a new and recently serviced Medsystem III® instrument. The following check-in and configuration procedures are taken from the current service manual.

- Electrical Safety Test
- Power Tests
- Cassette and Sensor Test
- Patient-side Occlusion Detector Test
- Fluid-side Occlusion Detector Test
- Air-in-Line Test
- Volume Accuracy Test
- Watchdog Audio Test

References (used in conjunction with this document):

- Model 2860 and 2863 Technical Service Manual.

## Physical Inspection

Before unpacking, check the shipping container for damage that may have affected contents. Report any shipping damage to Customer Service.

Check to insure that all accessories are included in the package.

Check for any physical damage to the instrument or accessories. If any is found report it to Customer Service.

## Functional Test

Refer to your institutions policies for specific requirements regarding inspection and testing of incoming equipment before use. Recommended functional tests are given in the following pages. As a minimum, the following steps should be performed before use.

- Charge battery for 14 hours.
- Perform electrical safety checks.
- Turn instrument on to verify normal power-up and operation of LEDs, display and audio.



## Check-In Tests

Check-In tests are recommended prior to clinical use. When a test requires a primed cassette, it is recommended that clean tap water be used for such tests. If any of the functions are not as described in the check procedures, then the instrument requires service. Please call ALARIS Medical Systems® Customer Service at 800-482-4822 or refer to qualified Biomedical technician.

**Note:** Upon completion of Check-In tests, reset the following: Volume Remaining, Time and Rate.

### WARNING

For proper grounding, the AC adapter must always be connected to a three-wire outlet. Never operate the MedSystem III® instrument from a two-wire, ungrounded outlet.

### WARNING

Do not perform any of the following tests while the instrument is in use on a patient. Review all precautions in the Directions for Use before performing these tests.

## Electrical Safety Test

Equipment Required:

NAME	MANUFACTURER	MODEL NUMBER
ELECTRICAL SAFETY TESTER	DALE TECHNOLOGY CORPORATION	LT544D OR EQUIVALENT

This checks the ground continuity and leakage current of the AC adapter/instrument, and can only be performed with the AC adapter connected to the instrument.

**Note:** The pole clamp is isolated from the internal electronics and, therefore, is not grounded. It should not be used while performing the electrical safety test.

To perform Electrical Safety Test:

1. Refer to the operation manual for the electrical safety tester for the proper setup and measurement technique.
2. Connect the AC adapter to the instrument.
3. Plug the AC adapter into the electrical safety tester.
4. Measure the ground continuity and leakage current. Any point of an instrument with an aluminum chassis can be used for testing. A black coated chassis can only be tested at the uncoated test point, located toward the back of the chassis under the lower housing. Verify the following:
  - Ground continuity not to exceed 0.1 ohm.
  - Leakage current not to exceed 100 $\mu$ A.

Test Point  
(Black-coated Chassis only)

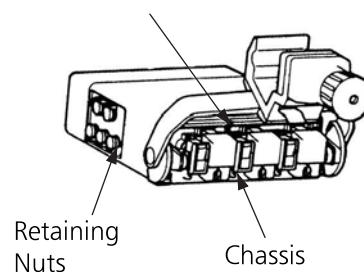

## Power Tests

### A. Power-Up Test

Charge the instrument for at least one hour before performing this test. Proceed with the power-up test as follows:

1. Disconnect the AC adapter from the instrument.
2. Remove any cassettes installed in the instrument.
3. Turn the instrument on and verify proper power-up.
4. The instrument performs initial self-test during power-up; and, if it detects any problems, it will indicate a fault.
5. Check audio and keypad operation by ensuring there is a soft beep for each key press.
6. Press any key and ensure the LCD backlight turns on.

**Note:** For a complete memory self-test, the instrument should be turned on for a minimum of 10 minutes for the Model 2860 and 18 minutes for the Model 2863 or 2865 instruments. It is not necessary for the unit to be pumping to perform this test. If operating on battery power, a cassette must be installed in at least one of the channels and that channel put in standby mode; otherwise, the instrument will automatically shut off after five minutes of inactivity.

### B. AC Power Test

1. Turn on the instrument without the AC adapter attached.
2. Install a primed cassette in each pump channel.
3. Start all channels (at any rate). Verify the green LED on each channel blinks during operation.
4. Attach the AC adapter to the pump. Verify that the instrument beeps three times when the connector is properly installed. Verify that the green plug-shaped light on the side connector panel is lit and does not blink if you wiggle the connector.
5. Verify that the green LEDs for each channel key (A, B and C) are steadily illuminated. If they are blinking, then the instrument is not recognizing that AC power is connected.

## Cassette and Sensor Test

This test verifies the proper functioning of the cassette and latch sensors, as well as the latching mechanisms. Repeat the following procedures for all three channels (A, B and C).

1. With the instrument off, remove any cassettes that are installed in the instrument.
2. Turn on the instrument.

## Cassette and Sensor Test (Continued)

3. Verify that the pump latch mechanism of each channel returns to the **Home** position at the top of the stroke (nearest to the chassis).
4. Press the channel select key (A, B or C), and then press the START/STOP key. A two-tone advisory will sound and the highlighted message **Install Cassette** will appear in the prompt line near the bottom of the screen.
5. Install a primed cassette into the appropriate channel (A, B or C), but do not push the cassette slide clamp into place. Ensure that there are no air bubbles.

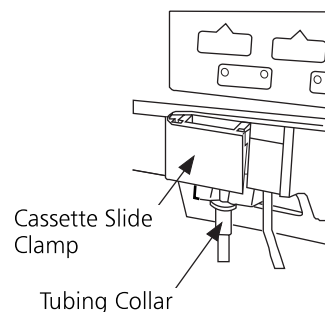

Slide Clamp Not In Place

6. Press the START/STOP key again. A two-tone sound will be emitted, and the message **Push Slide Clamp In** will appear at the bottom of the page.
7. Push the cassette slide clamp in and seat the tubing collar in the recess below the cassette. Three beeps will sound to indicate correct cassette installation and fluid in the sensor pathway. The cassette should latch easily and smoothly. If the air-in-line sensor detects air when a cassette is installed, a **Check Air Sensor** advisory will be displayed.

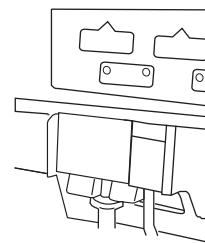

Slide Clamp In Place

8. Press the START/STOP key. The message **Infusing** will appear on the channel status line.
9. While the channel is pumping, pull out the cassette slide clamp. You will hear a repeating four-beep audio alarm and the red LEDs will blink. Infusion will stop and the display will indicate a **Cassette Not Latched** alarm.
10. Remove the cassette. The alarm display should read **Cassette Removed**. Reset the alarm by pressing the channel select key (A, B or C) for the channel in use, and press the CANCEL softkey.

## Patient-side Occlusion Detector Test

This test verifies the proper functioning of the alarm which detects occlusion between the instrument and the patient. Repeat the following steps for each of the three channels, A, B, and C.

1. Configure the instrument in the Controller Pressure Device Type.
2. Prime a set, which contains *no filters or check valves, and has macrobore tubing on the patient side.*
3. Install the primed set into the Channel Under Test (CUT).
4. Set the infusion rate for 1 ml/h, for the CUT.
5. Press the START/STOP key to start infusion.
6. Raise the patient-side tubing 2' 2" above the cassette. The CUT should not sound an alarm.
7. Slowly raise the tubing outlet to 3' 8" above the cassette. The CUT should sound an alarm within 10 seconds.
8. After completing steps 1-7 for all three channels configure the instrument in the General Purpose Device Type.

## Fluid-side Occlusion Detector Test

This test verifies the proper functioning of the alarm which detects occlusion between the instrument and the fluid container. Repeat the following steps for each of the three channels, A, B and C.

1. Install a primed set in the selected channel
2. Start the selected channel at 125 ml/h.
3. Close the roller clamp between the instrument and the fluid container. The occlusion should be detected within two minutes.
4. The Standard Display screen will show an alarm for the channel under test and also the message **Fluid Side Occluded**. The red LED in the key for the test channel will blink, and an audible four-beep alarm will sound.
5. Open the roller clamp and press the START/STOP key to reset the alarm.

## Air In Line Detector Test

This test verifies the proper functioning of the alarm which detects air in a line. Repeat the following procedure for each of the channels, A, B and C.

1. Disconnect the drip chamber from the solution bottle, or inject a large air bubble into the tubing via the upstream y-site.

---

**Note:** *The injected air bubble size should be approximately twice the threshold value of the air detector plus one milliliter to fill the cassette air trap. For example, if the threshold is 500 microliters, then inject a 2-milliliter air bubble. To determine the threshold value, check the Clinical Configuration settings in the instrument.*

2. Press the START/STOP key on the selected cassette. When the bubble is pumped through the cassette, the Standard Display should show an alarm for the channel under test with the message, ***Air In Line***. An audible four-beep alarm will sound and the red LEDs will blink.

## New Instrument Volume Accuracy Test

Accuracy of fluid delivery is determined by measuring the volume of fluid delivered over a known time period and comparing this to the expected value. To ensure accurate measurements during the test, a volumetric glass burette (class A) must be used to collect the fluid. The infusion time interval must be 180 seconds or greater to minimize measurement errors. During a 180-second test, a one-second error by the operator results in an error of 0.6%.

### A. Test Equipment Setup

1. Obtain a new administration set and connect it to a 500-milliliter container which is at least half full. Prime the set and eliminate all air.
2. Connect the apparatus as shown in Test Equipment Setup below. Use a volumetric burette marked in 0.1-milliliter increments (class A glassware).
3. Install the cassette to the channel to begin test.

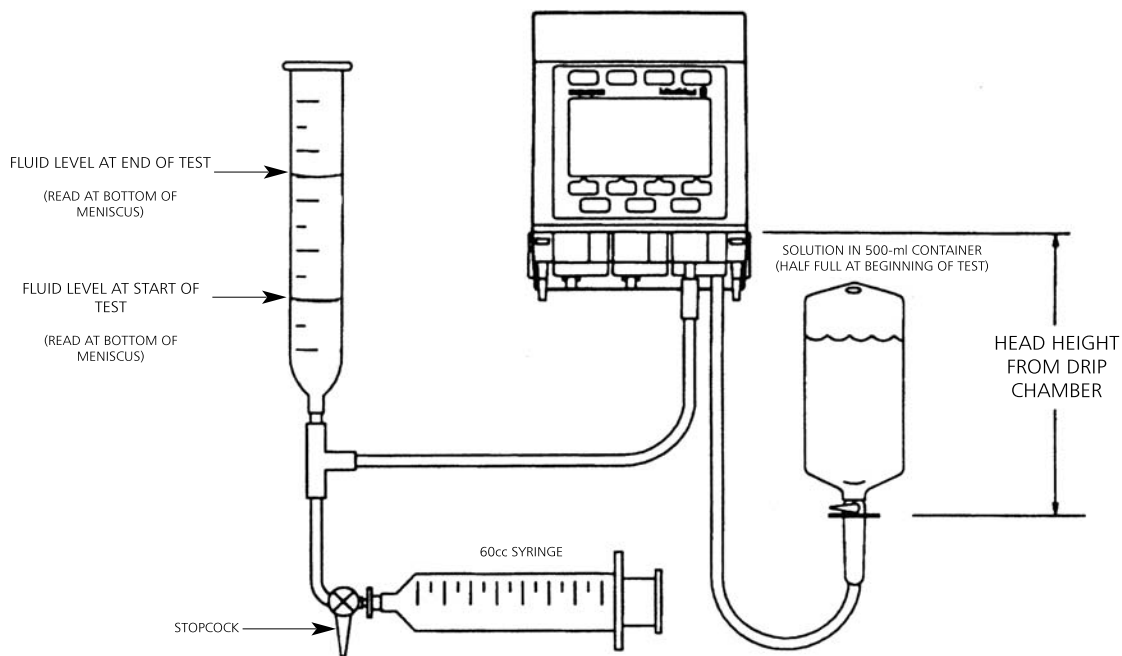

Test Equipment Setup

## Watchdog Audio Test

Manually test the Watchdog Alarm Audio from the Standard Display. Press the **More Options** button two times until a softkey labeled Demo WD appears. Press this key and follow the directions on the screen for completing the Watchdog Test.

### B. Test Procedure

1. Power up the Unit Under Test (UUT),
2. Press the MORE OPTIONS key.
3. Press the CONFIG soft key.
4. Press the SELECT soft key twice to highlight the Set up line option.
5. Press the ↑ arrow soft key to toggle setting to **Yes**.
6. Press the ENTER soft key to accept setting.
7. Set the meniscus level to 0 in the burette.
8. Press the A key to select Channel-A.
9. Press the SELECT soft key 4 times to highlight Setup option.
10. Press the ↑ arrow soft key to toggle setting to **Select VR and Time**.
11. Press the ENTER soft key to accept setting.
12. Press the SELECT soft key to highlight **Pri VolRem (VR)**.
13. Press the ↑ arrow soft key until the (VR) is set to 18 ml.
14. Press the ENTER soft key to accept setting.
15. Press the SELECT soft key to highlight **Pri Time (TR)**.
16. Press the ↓ arrow soft key until the (TR) is set to 00h 03m.
17. Press the ENTER soft key to accept setting.
18. Press the CLEAR soft key to set the "Pri Vol Inf (VI)" to 0ml.
19. Press the ENTER soft key to accept setting.
20. The Primary Rate should read 360 ml/h.
21. Press the START/STOP key to start Channel-A. Channel-A will run for 3 minutes.
22. Press the START/STOP key within 1 second after the channel goes into KVO alarm.
23. The volume collect will be between 17.1 ml and 18.9 ml.
24. Repeat steps 7 - 23 for Channels B and C.
25. After testing all three channels repeat steps 1-6 with the exception in step 5 to toggle setting to **No**.

## Cleaning

Clean the pump regularly to maintain proper working order and optimum performance.

- DO NOT** invert the pump during cleaning or rinsing.
- DO NOT** clean the pump without first inspecting the condition of the housings for damage.
- DO NOT** use pressurized air to dry the pump, as the force may move fluid past the moisture seals.
- DO NOT** use organic solvents, ammonia, ammonium-based agents, and/or abrasive cleansers.
- DO NOT** damage valve actuators.
- DO NOT** use sharp or metallic tools to remove residue.

## Before Cleaning

**Note:** If the power cord is permanently attached to the pump, ensure cleaning solution does not enter the connector.

1. Unplug the AC adapter power cord from the wall outlet.
2. Disconnect the power cord from the external power connector, on the side of the pump.
3. Inspect the pump's outside surfaces for damage.
  - Any cracks or punctures may allow fluid to enter.

## To Clean

For cleaning applications:

- use solutions of non-abrasive, non-staining detergent (i.e., commercially available, alcohol-free, dishwashing liquid) well diluted with warm water.
- use either Cavicide or 10% chlorine bleach and water for disinfecting.
- rinse with distilled or de-ionized water.
- use soft, non-abrasive cloths, soft-bristled brushes and/or non-abrasive, lint-free swabs.

### The Pump, lower housing, slide link and latch

1. Wipe the pump exterior using a cloth dampened with cleaning solution.
2. Remove the lower housing to access the pump's lower assembly by pressing all four black, release tabs simultaneously while pulling straight down.

## WARNING

Turn the instrument off and disconnect the power cord from the AC power source before cleaning. Do not spray fluids directly onto the rear case of the instrument. Do not steam autoclave, EtO sterilize, immerse the instrument or allow fluids to enter the instrument case. Failure to follow these instructions may result in an electrical hazard.

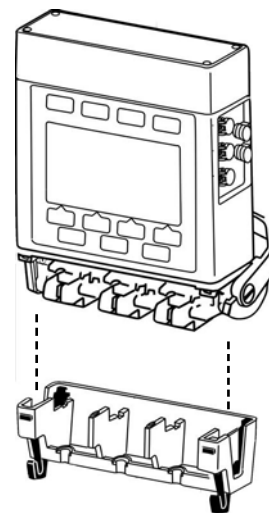



## To Clean (Continued)

### The Pump, lower housing, slide link and latch (Continued)

3. Set the pump upright.
4. Clean the slide link and pump latch mechanism using a small soft-bristled brush (or lint free swab) dampened with the appropriate cleaning solution, as specified in the "Cleaning" section. If dried residue is difficult to remove, or the slide link or pump latch sticks, spray the cleaning solution on the residue and allow it to soak until it can be more easily removed.
5. After removing residue, rinse with a lint free swab dampened with water. Water may be sprayed on the cleaned surfaces to rinse areas that are difficult to reach with a swab.
6. Dry with a lint-free swab or cloth, or allow to air dry.

### Air Sensor Recess

**NOTE:** Air-in-line alarms may occur when dried residue builds up in the air-in-line sensor tubing recess.

1. Inspect the air-in-line sensor module to ensure that there is no separation or breakage of the glued seams.

**NOTE:** Defective air-in-line sensor modules must be replaced before using the instrument.

2. Place the instrument in the upright position.
3. Clean the tubing recess (using a downward motion) with a lint free swab dampened with the appropriate cleaning solution, as specified in the "Cleaning" section.
4. Rinse with a lint free swab dampened with water.
5. Dry with a lint-free swab or allow to air dry.

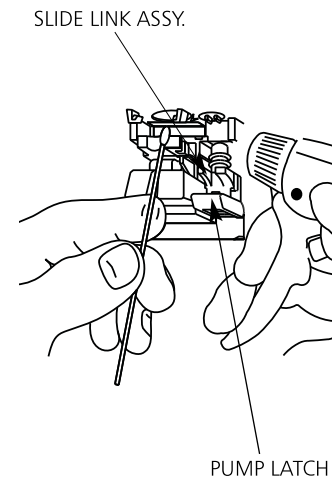

### CAUTION

Use of abrasives or abrasive cleaners on air sensor recess may cause false Air-in-line or Check Air Sensor alarms.

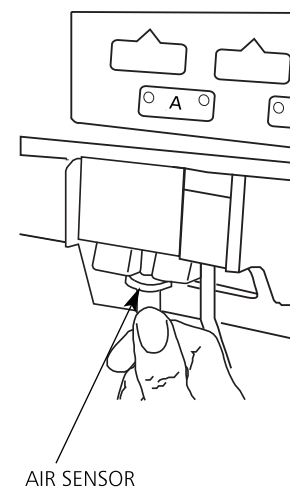

## To Clean (Continued)

### Optomodule

1. Place the instrument in the upright position.
2. *Gently* clean the optomodule using a lint-free swab dampened with the appropriate cleaning solution, as specified in the "Cleaning" section. The cleaning solution may be sprayed on difficult-to-remove residue to help wet and soften the residue for easier removal.
3. After removing residue, *gently* rinse with a lint-free swab dampened with water. Water may be sprayed on the cleaned surfaces to rinse areas that are difficult to reach with a swab.
4. *Gently* dry with a lint-free swab or allow to air dry.

### Valve Actuator

1. Place the instrument in the upright position.
2. *Gently* clean the valve actuator and actuator seal using a lint-free swab dampened with the appropriate cleaning solution, as specified in the "Cleaning" section. The cleaning solution may be sprayed on difficult to remove residue to help wet and soften the residue for easier removal.
3. After removing residue, *gently* rinse with a lint-free swab dampened with water. Water may be sprayed on the cleaned surfaces to rinse areas that are difficult to reach with a swab.
4. *Gently* dry with a lint-free swab or allow to air dry.
5. After cleaning, inspect the exposed tips of the valve actuators. A broken tip may be supported by the actuator seal and not appear defective. Lightly attempt to push the tips of the valve actuators from side to side with a dry lint-free swab. If a tip is not rigid, then it is broken and must be replaced before using the instrument.

### After cleaning

Inspect the exposed tips of the valve actuators for damage by lightly pushing the tips of the valve actuators side-to-side with a dry swab. If a tip is not rigid, it is broken and must be replaced before using the pump.

### **WARNING**

Failure to perform these inspections may result in improper instrument operation.

### **CAUTION**

Do not use isopropyl alcohol on the optomodule.

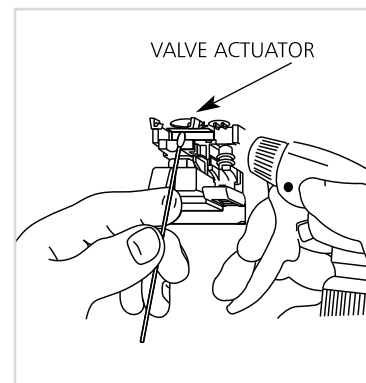
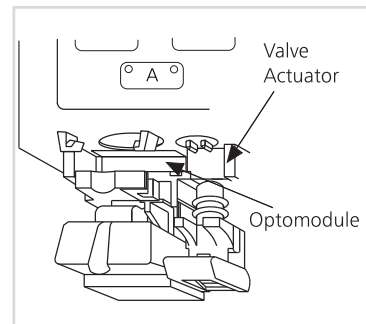

### **WARNING**

Care must be taken when cleaning the vicinity of the valve actuators to avoid damage and breakage of the actuator tips. Damage or breakage of the actuator tips could cause an uncontrolled flow condition.

### **CAUTION**

Do not use isopropyl alcohol to clean the valve actuators.

## Inspection Requirements

To ensure the pump remains in good operating condition, both regular and periodic inspections are required. Any instrument that does not meet listed specifications should be serviced.

Regular inspections consist of performing the procedures described in the Basic Operation and Cleaning sections of this manual before use of the pump. Regular inspections are not covered under any contract or agreement offered by ALARIS Medical Systems, Inc., and must be performed by the user.

When programming infusions verify that the display:

- Is complete and not blurred.
- Reads the same as described in this manual.
- Responds with the intended function for that key press.

*NOTE: Detailed instructions for performing periodic inspections and maintenance can be found in the Technical Service Manual for the MedSystem III® Multi-Channel Infusion Pump and in supplemental service bulletins.*

Periodic inspections must be performed every 12 months. A service agreement may be obtained from ALARIS Medical Systems, Inc., for the performance of all required periodic inspections.

The periodic inspections must be performed in accordance with ALARIS Medical Systems, Inc. requirements and guidelines. Customers within the United States and Canada should note that these inspections are also intended to complement the intent of Joint Commission on the Accreditation of Healthcare Organizations requirements.

### WARNING

Failure to perform these inspections may result in improper instrument operation.

## Service Information

**NOTE:** *If the instrument shows evidence of damage in transit, notify the carrier's agent immediately. Do not return damaged equipment to the factory before the carrier's agent has authorized repairs.*

If the instrument fails to respond as described in this document and the cause cannot be determined, do not use the instrument. Contact qualified service personnel.

Within the United States, application and service information may be obtained by writing to ALARIS Medical Systems, Inc. at:

ALARIS Medical Systems, Inc  
9190 Activity Road  
San Diego, California 92126  
ATTN: Instrument Service

Within the United States and Canada, information or assistance may be obtained by calling one of the following Customer Service toll-free numbers:

In United States:	(800) 482-4822
In Canada:	
<i>Eastern</i>	(800) 908-9918
<i>Western</i>	(800) 908-9919

Within the United States and Canada, Corporate Technical Support can be contacted by calling the following toll-free number:

(800) 854-7128

Outside the United States and Canada, service information, applications, and manuals may be obtained by contacting your local ALARIS Medical Systems Service Department or distribution center.

When submitting any request for service, include:

- description of difficulty experienced.
- instrument serial number.
- instrument settings and solution(s) used.
- description, model and lot number(s) of any disposables in use.
- message displayed at time of difficulty.

If it is necessary to return the instrument for service, obtain a return authorization number prior to shipment. Carefully package the instrument (preferably in the original packaging), reference the return authorization information, and return it to the appropriate service or distribution center. ALARIS Medical Systems, Inc. does not assume any responsibility for loss of, or damage to, returned instruments while in transit.

THIS PAGE  
INTENTIONALLY  
LEFT BLANK

## WARRANTY

ALARIS Medical Systems, Inc., (hereinafter referred to as "ALARIS Medical Systems") warrants that:

- A. Each new ALARIS Medical Systems® instrument excluding battery is free from defects in material and workmanship under normal use and service for a period of one (1) year from the date of delivery by ALARIS Medical Systems to the original purchaser.
- B. The main battery and each new accessory is free from defects in material and workmanship under normal use and service for a period of ninety (90) days from the date of delivery by ALARIS Medical Systems to the original purchaser.

If any product requires service during the applicable warranty period, the purchaser should communicate directly with the relevant account representative to determine the appropriate repair facility. Except as provided otherwise in this warranty, repair or replacement will be carried out at ALARIS Medical Systems' expense. The product requiring service should be returned promptly, properly packaged and postage prepaid by purchaser. Loss or damage in return shipment to the repair facility shall be at purchaser's risk.

In no event shall ALARIS Medical Systems be liable for any incidental, indirect or consequential damages in connection with the purchase or use of any ALARIS Medical Systems® product. This warranty shall apply solely to the original purchaser. This warranty shall not apply to any subsequent owner or holder of the product. Furthermore, this warranty shall not apply to, and ALARIS Medical Systems shall not be responsible for, any loss or damage arising in connection with the purchase or use of any ALARIS Medical Systems® product which has been:

- (a) repaired by anyone other than an authorized ALARIS Medical Systems service representative;
  - (b) altered in any way so as to affect, in ALARIS Medical Systems' judgment, the product's stability or reliability;
  - (c) subjected to misuse or negligence or accident, or which has had the product's serial or lot number altered, effaced or removed;
- or
- (d) improperly maintained or used in any manner other than in accordance with the written instructions furnished by ALARIS Medical Systems.

This warranty is in lieu of all other warranties, express or implied, and of all other obligations or liabilities of ALARIS Medical Systems, and ALARIS Medical Systems does not give or grant, directly or indirectly, the authority to any representative or other person to assume on behalf of ALARIS Medical Systems any other liability in connection with the sale or use of ALARIS Medical Systems® products.

ALARIS Medical Systems DISCLAIMS ALL OTHER WARRANTIES, EXPRESS OR IMPLIED, INCLUDING ANY WARRANTY OF MERCHANTABILITY OR OF FITNESS FOR A PARTICULAR PURPOSE OR APPLICATION.

See packing inserts for international warranty, if applicable.

THIS PAGE  
INTENTIONALLY  
LEFT BLANK

## Abbreviations, Acronyms, Units of Measure

1° Pri	Primary infusion
2° Sec	Secondary infusion
a	am
AAMI	American Association of Medical Instrumentation
ABS	acrylonitrile-butadiene-styrene
AC	alternating current (electrical power)
BatLog	Battery History Log
Calc	Calculator
CalcOff	Calculator Off
CalcOn	Calculator On
ClrAir	Clear Air
Cntrst	Contrast
COMM	Communications Port
Conc	Concentration
Config	Configuration
CP	Controller Pressure
CSA	Canadian Standards Association
DemoWD	Demonstrate Watchdog
DI	Dose Infused
ECG	Electro-cardiogram
ES	Electro-static
FMS	Field Maintenance Software
Gm	gram
GP	General Purpose
GP II	General Purpose II
h	hour
Hz	Hertz
in.	inch
I.D.	identification
IEC	International Electrotechnical Commission
Inf	infused
IV	intravenous
JCAHO	Joint Commission on the Accreditation of Health Care Organizations
K	1,000 for numbers 10,000 or greater
KG; kg	kilogram
KVO	keep vein open
LB; lb	pound
mcg	microgram
mEq	milliequivalent
mg	milligram
min; mn	minute



## Abbreviations, Acronyms, Units of Measure (Continued)

<b>ml</b>	milliliter
<b>mMol</b>	millimole
<b>mUn</b>	milliunit
<b>μl</b>	microliter
<b>N/A</b>	not applicable
<b>Neontl</b>	Neonatal
<b>NextPg</b>	Next Page
<b>Ng</b>	Nanogram
<b>NiCd</b>	nickel-cadmium
<b>OR</b>	Operating Room
<b>OR II</b>	Operating Room II
<b>p</b>	pm
<b>Pri</b>	Primary
<b>psi</b>	pounds per square inch
<b>Sec</b>	Secondary
<b>Stnd Disp</b>	Standard Display
<b>STNDBY</b>	Standby
<b>TotVol</b>	Total Volume
<b>TR</b>	time remaining
<b>UL</b>	Underwriters Laboratories, Inc.
<b>Un</b>	unit
<b>V</b>	Volts
<b>VI</b>	volume infused
<b>Vol</b>	volume
<b>VolRem</b>	volume remaining
<b>VR</b>	volume remaining
<b>Wt</b>	weight



ALARIS Medical Systems, Inc.  
10221 Wateridge Circle  
San Diego, California 92121 U.S.A.  
(800) 854-7128 (ext. 7182)

Mail:  
P.O. Box 85335  
San Diego, California 92186-5335 U.S.A.

ALARIS®, ALARIS Medical Systems®, MedSystem III® are registered trademarks of ALARIS Medical Systems, Inc.  
*All other trademarks belong to their respective owners.*

U.S. Patent Nos. 4,712,583; 4,814,685; 4,832,299; 4,850,817; 4,884,065; 4,919,596; 4,950,235; 5,006,110; 5,009,641; 5,041,086; 5,053,747; 5,064,412; 5,126,616; 5,149,603; 5,176,631; 5,243,510; 5,382,232; 5,616,124; 5,772,635; D309,662; D381,622. Italy Patent Nos. 247,824; 0,346,548; 319,277; 319,268; 416,911; 419,094. Canada Patented/Breveté 1,297,531; 1,317,582; 1,319,069; 1,329,896; 1319,066; 1,319,065; 1,319,068; 2,024,436; 2,024,426; 2,024,435; 2,054,146; 2,039,807, 81,348. France Brevet Nos. 247,824; 0,346,548; 319,277; 319,268; 416,911; 419,094; 453,211. British Patent Nos. 247,824; 0,346,548; 319,277; 319,268; 416,911, 419,094; 453,211. Germany D.B.P. Nos. P3751314.1-08; 0,346,548; P38789895; P3855745; P69026170.5-08; P69020832; P69117325.7. Netherlands Patent Nos. 247,824; 0,346,548; 319,277; 319,268; 416,911; 419,094. Japan Patent Nos. 特許第 2,695,878 号, 特許第 2,833,765 号, 特許第 2,801,617 号, 特許第 2,695,879 号, 特許第 2,732,534 号, 特許第 3,236,308 号, 特許第 3,288,415 号. Sweden Patent Nos. 247,824; 319,268; 416,911; 419,094. Other U.S. and Foreign Patents Issued and Pending.